

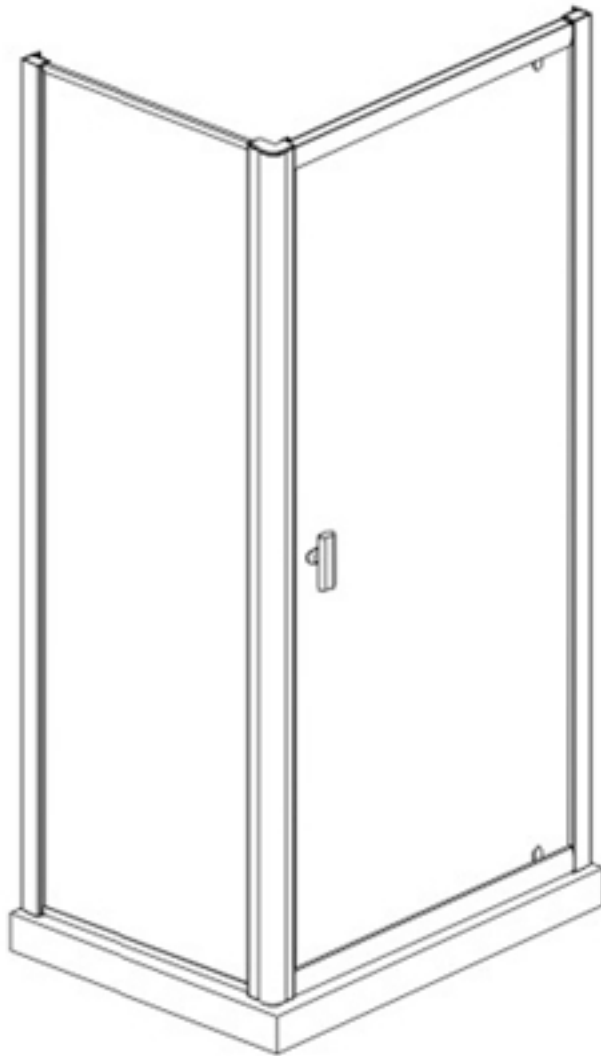

**INSTALLATION INSTRUCTIONS FOR
PENDENNIS AND PENDEEN SHOWER ENCLOSURES**



◆ General Information

Please inspect the product immediately upon receipt for transit damage, missing packs/parts or manufacturing fault. Damage reported later cannot be accepted. Please handle the product with care avoiding knocks and shock loading to all sides and edges of the glass.

Notes: Safety glass can not be re-worked.

Please read these instructions carefully before start of installation.

Special care should be taken when drilling walls to avoid hidden pipes or electrical cables.

Note: This product is heavy and may require two people to install.

Aftercare instructions

After use, your shower should be cleaned with soap and water. This is particularly important in hard water districts where insoluble lime salts may be deposited and allowed to build up. Cleaners of a gritty or abrasive nature should not be used. Care should be taken to avoid contact with strong chemicals such as organic solvents and strippers.

Glass cleaners can be used but with caution, if in doubt contact the manufacturer of the cleaner in question.

Please keep these instructions for aftercare and customer service details.



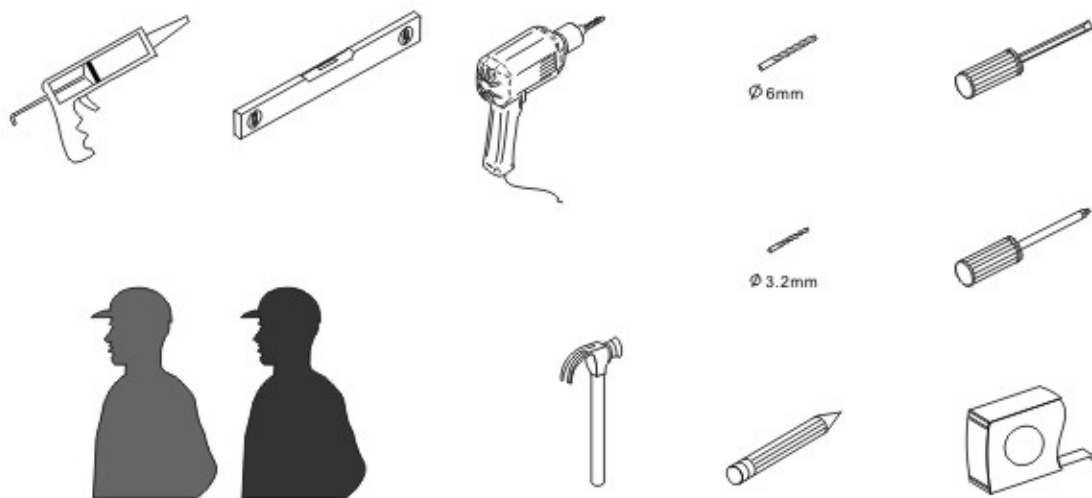







Tools Required







This product is heavy and may require two people to install.



◆ Packing List (1200 Door Panel)

[1] 1xInstallation Instruction.	➔		
[2] 1xHandle Set.	➔		
[3] 4xProfile Covers.	➔		
[4] 8xWall Plugs. 8xRound Screws M4x35. 8xScrew Cover Caps.	➔		
[5] 8xScrews M4x8. 8xScrew Cover Caps.	➔		
[6] 3xWater Deflectors.	➔		
[7] 2xWall Posts.	➔		
[8] 1xDoor Panel.	➔		

◆ Packing List (800 Side Panel)

[1] 8xScrews M4x8. 8xScrew Cover Caps.	➔		
[2] 3xProfile Covers.	➔		
[3] 1xCorner Post.	➔		
[4] 1xSide Panel.	➔		

◆ Assembly Drawing

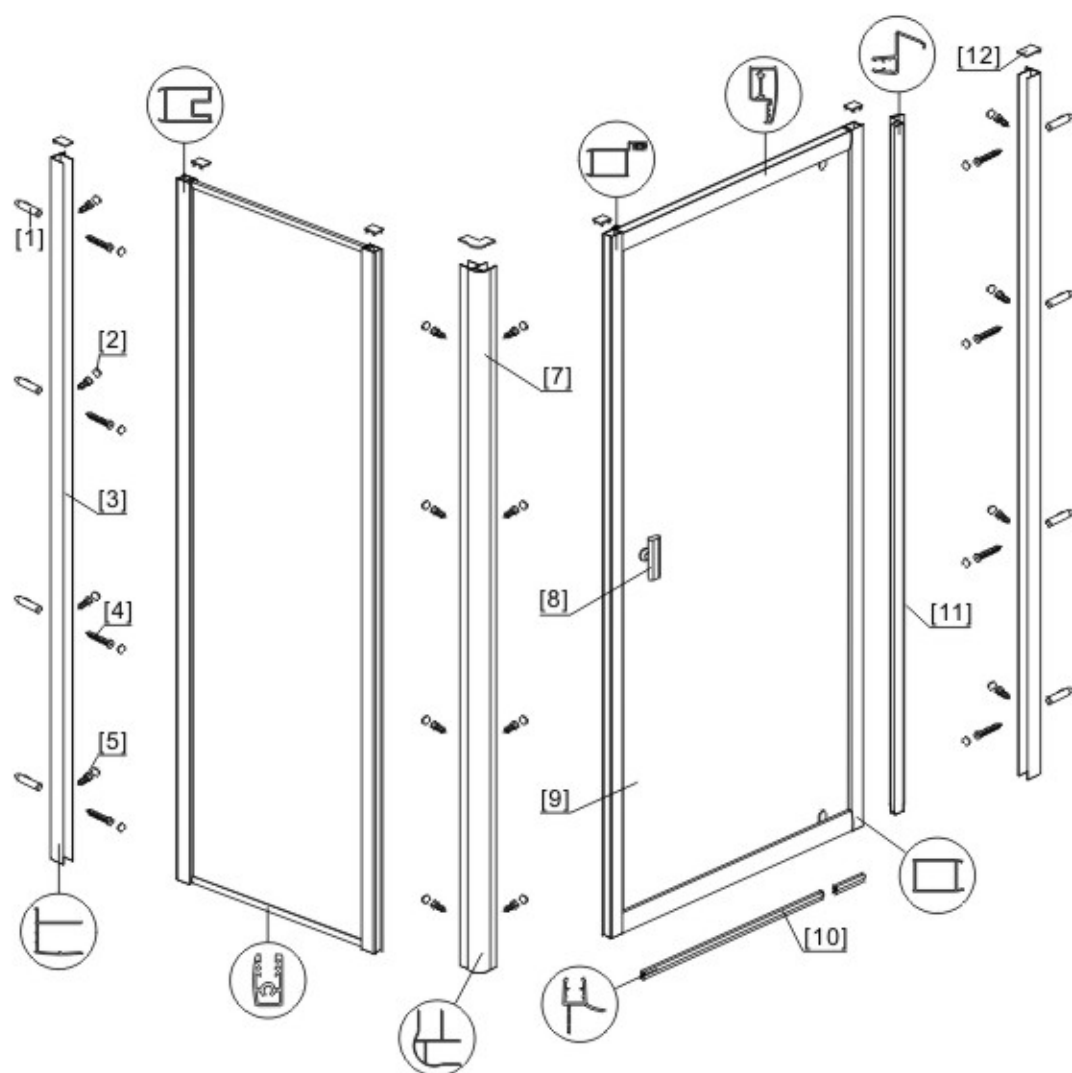

- [1] 8xWall Plugs
- [2] 24xScrew Cover Caps
- [3] 2xWall Posts
- [4] 8xScrews M4x35
- [5] 16xScrews M4x8
- [6] 1xFixed panel

- [7] 1xCorner Post
- [8] 1xHandle Set
- [9] 1xDoor Panel
- [10] 2xWater Deflectors
- [11] 1xWater Deflectors
- [12] 7xProfile Covers

◆ Installation steps:

Step 1

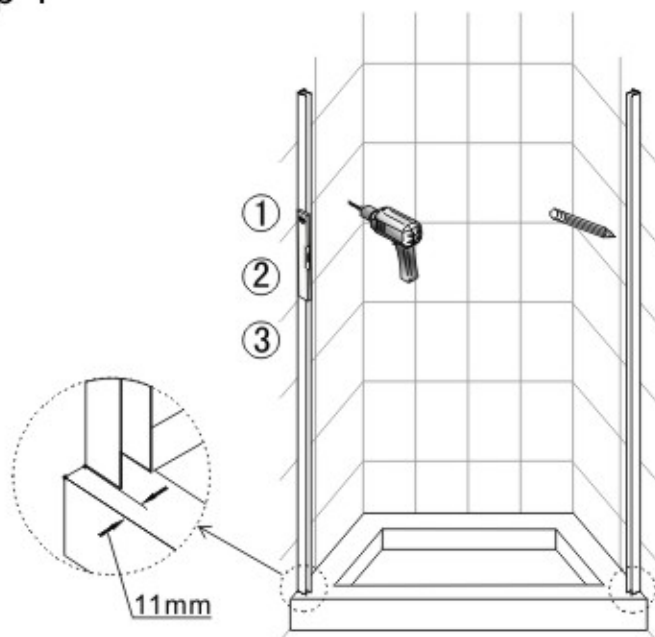

When install bifold front only,
Please refer to :Step 2.

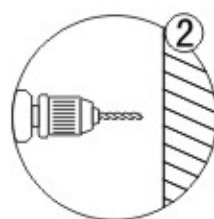

From wall corner to
the edge of wall post
711-761(760mm)
751-801(800mm)
851-901(900mm)

From wall corner to
the edge of wall post
643-688(700mm)
703-748(760mm)
743-788(800mm)
843-888(900mm)
943-988(1000mm)



When install the whole set enclosure,
Please refer to :Step 3-Step 6.

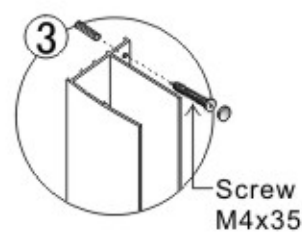
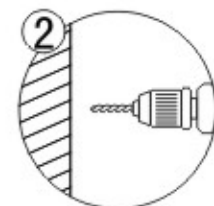
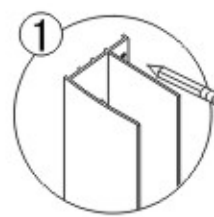

Step 2

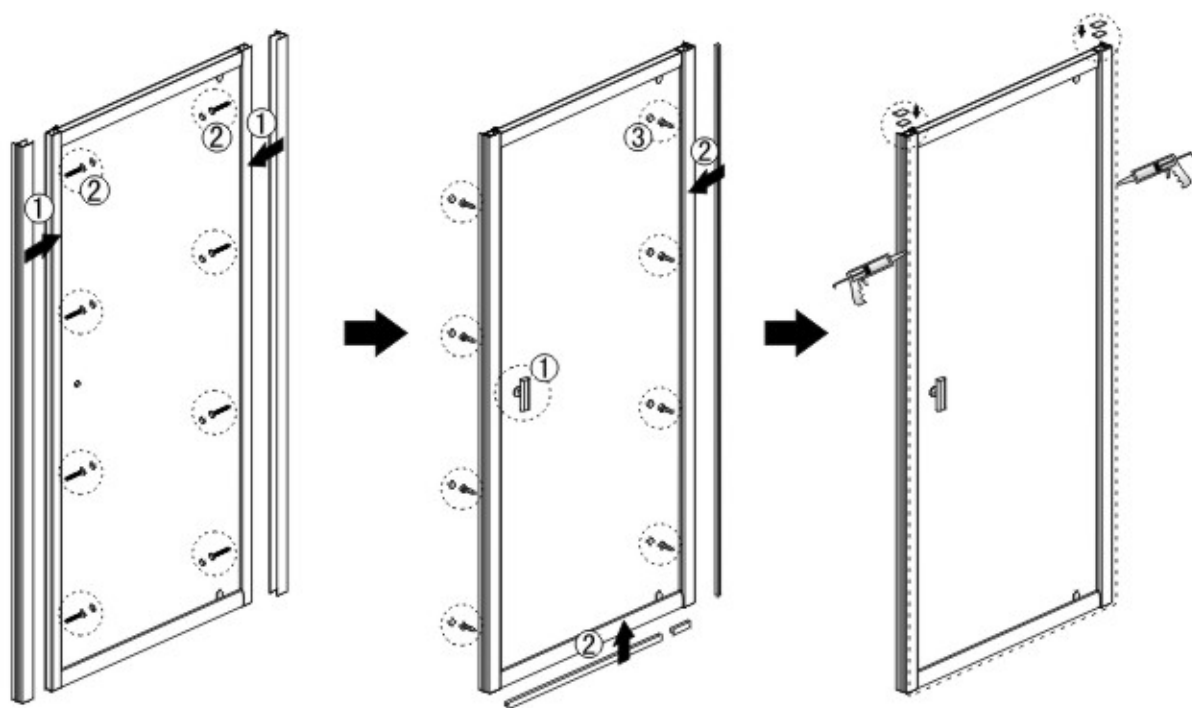

Step 3

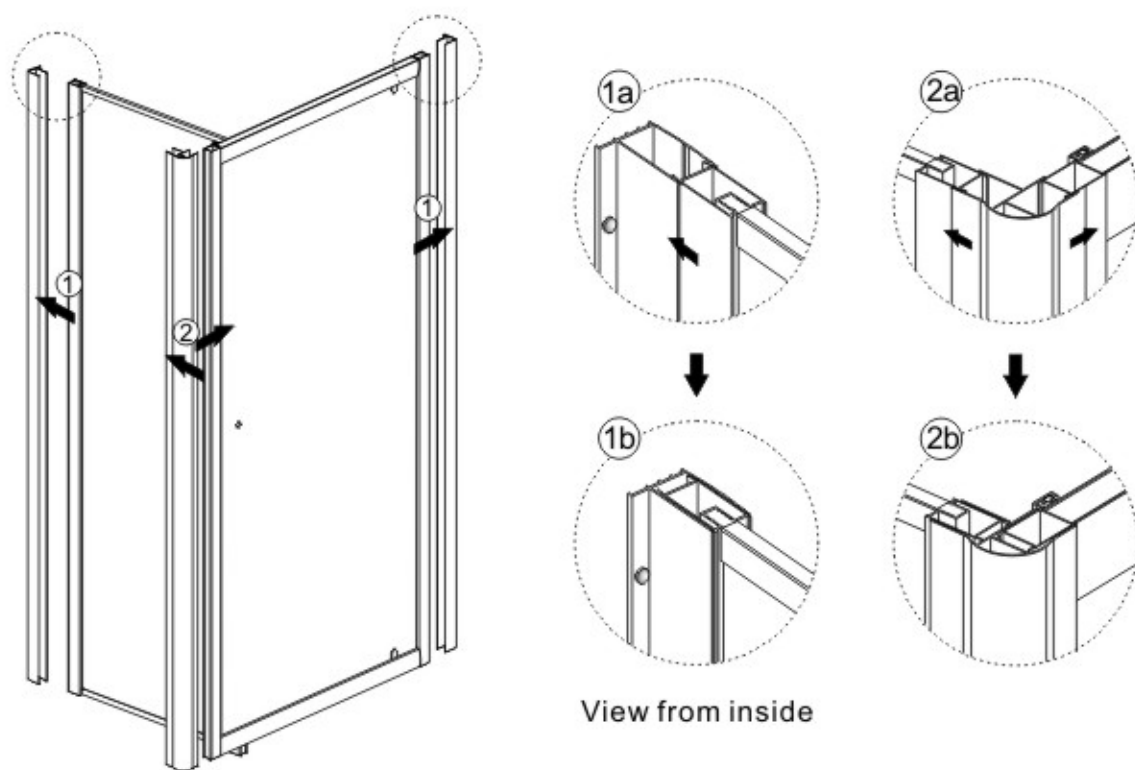

Step 4

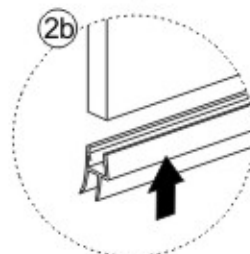
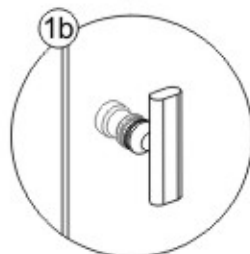
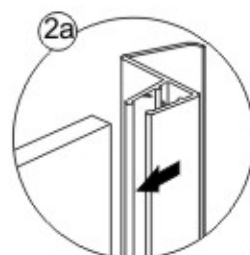
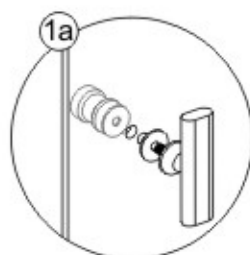
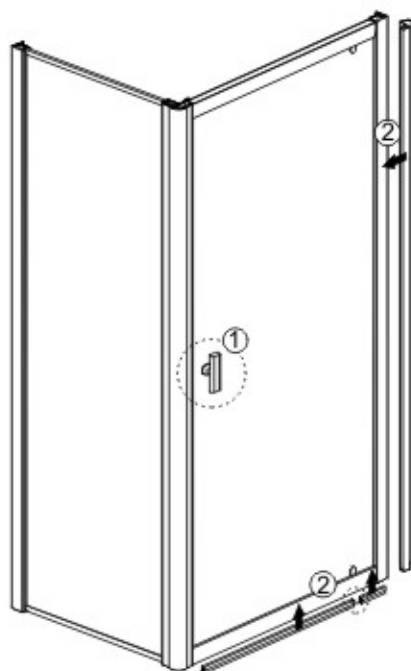

! Ensure wall profiles are plumb.
Adjust enclosure to be square and level.
Wheels should be adjusted to square the doors and ensure smooth running.

Step 5

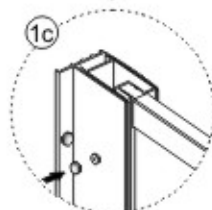
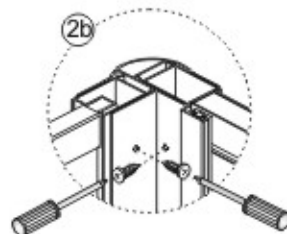
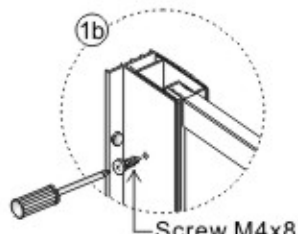
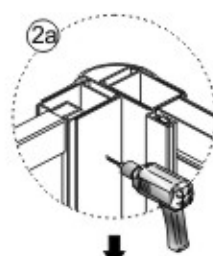
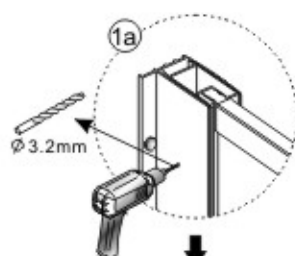
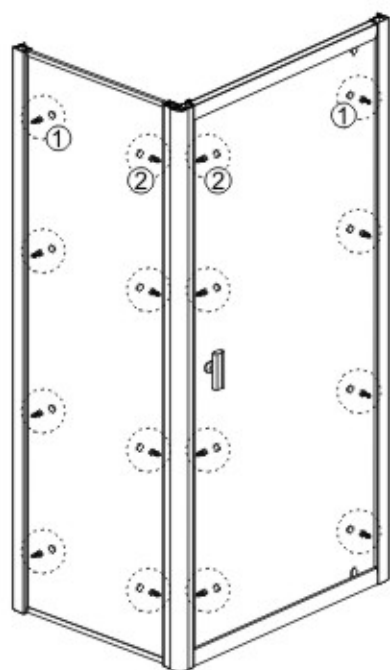

View from inside

Step 6

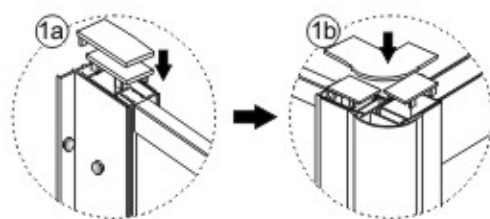
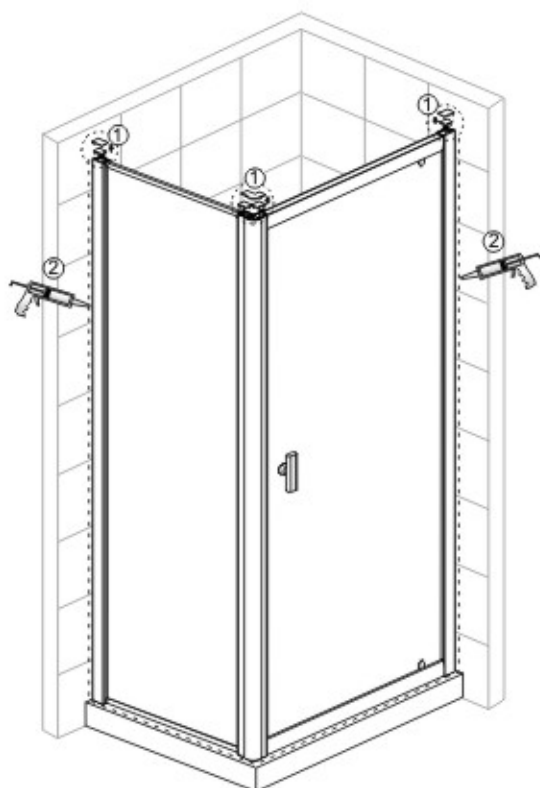

View from inside



Allow 24 hours for silicone to dry before use.