



PREMIUM **OFFSET QUADRANT** SHOWER ENCLOSURE
FITTING INSTRUCTIONS



heatandplumb
_____.com

Tel: 0844 855 3222 email:sales@heatandplumb.com

Page 1

IMPORTANT CHECKLIST

Before installation - please ensure...

- 1: The walls are reasonably flat and that the shower tray is level, properly sealed, and drains correctly.
- 2: There is no pipe work or cables behind walls where drilling.
- 3: Shower door is the correct size for the shower tray (see measurements below) and you have allowed for tiles.
- 4: There is no visual defect to the shower door.
- 5: Proper fixings are used for the appropriate wall type.

INSTRUCTION PRODUCT SIZES

These Instructions are specifically for the Duchy Offset Quadrant Shower Enclosure. Please Refer to the packaging to ensure that you have the one of the three sizes referred to in the table below...

Quadrant Tray Size	Dimensions (A) Min-Max	Dimensions (B) Min-Max
900mmx800mm	865mm - 895mm	765mm - 795mm
1000mmx800mm	965mm - 995mm	765mm - 795mm
1200mmx800mm	1165mm - 1195mm	765mm - 795mm
1200mmx900mm	1165mm - 1195mm	865mm - 895mm

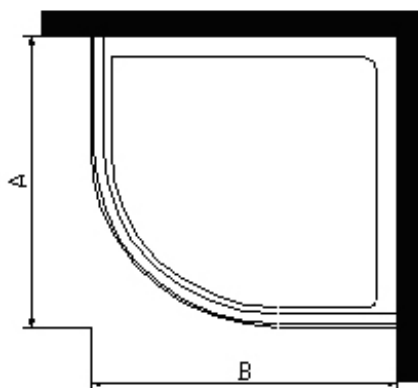

PRODUCT PARTS

The following pictures show the parts and the quantities included for this product. Please ensure that these parts are included before you start installing...

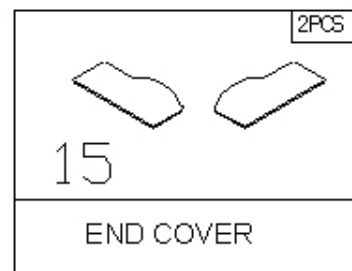
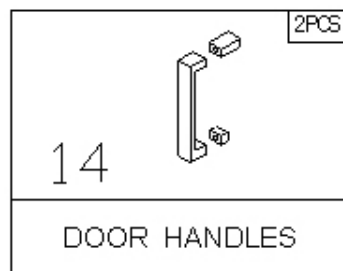
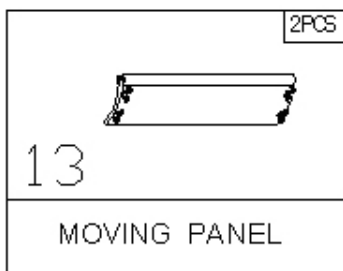
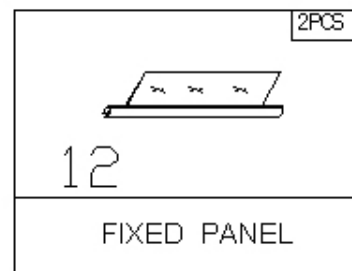
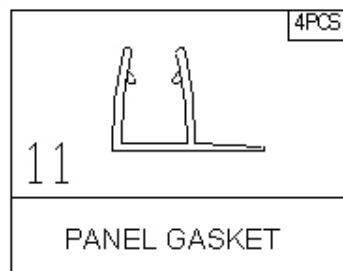
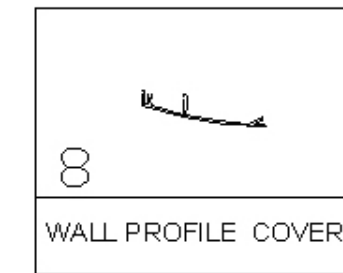
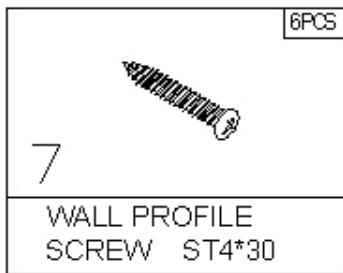
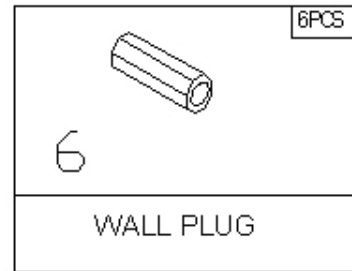
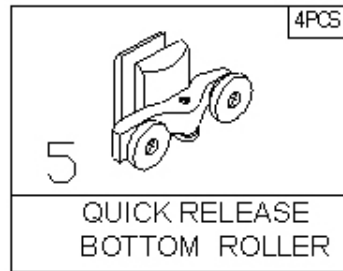
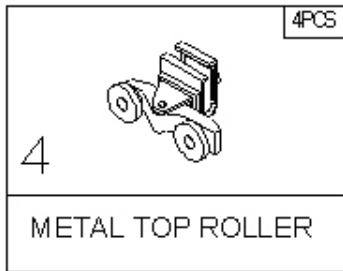
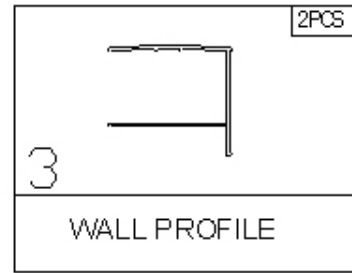
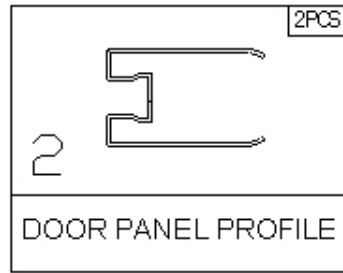
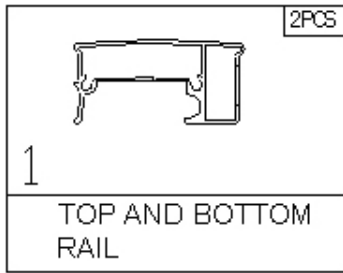

INSTALLATION PROCEDURE DIAGRAMS

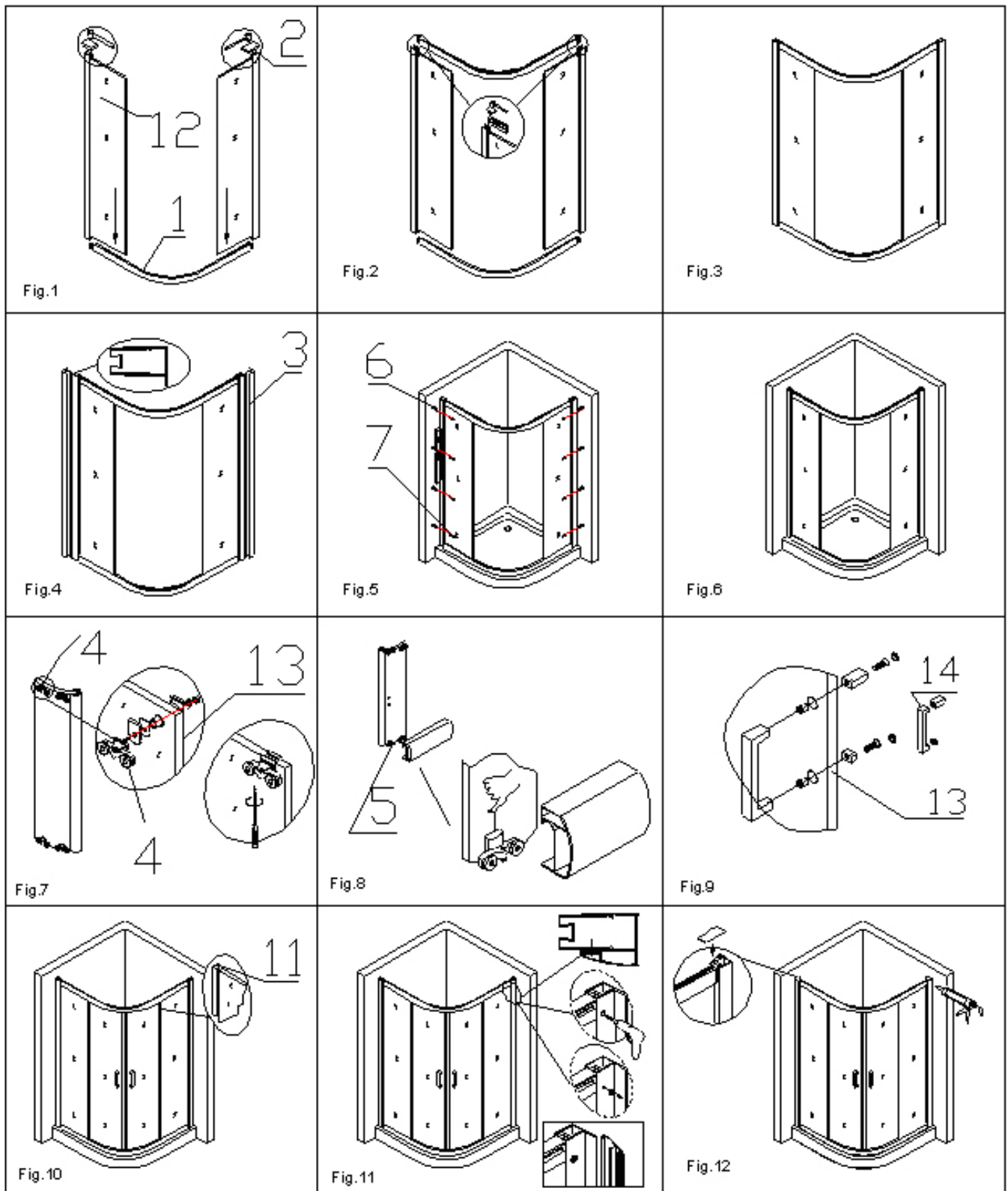

INSTALLATION PROCEDURE INSTRUCTIONS

- 1:** Install wall profiles (No.3) level in upright position using screws(No. 7) (see Fig.4)
It is ESSENTIAL to fix the wall profile 2mm above the shower tray to accommodate the door panel profiles.
- 2:** Build frame by attaching top and bottom profiles (No. 1) to fixed panels (No. 4) using fixing screws supplied(No. 8) secure on each corner making sure gaskets are fully inserted and pushed home as if not fully inserted this will result in doors not clip into position (see Fig. 1-3)
- 3:** Hang doors (No. 5) from top profile using adjustment to check for initial smooth running (see Fig.6), remove to fix frame to wall profiles (doors can be re-installed after frame is secured).
- 4:** Fix frame to wall profiles using screws (No.10) on inside. (see Fig. 5)
- 5:** Fix handles (No.12) to doors. (see Fig.9)
- 6:** Hang doors onto frame and adjust for smooth running.fit long plastic seals to fixed panel and door , do not use for 24hours.
- 7:** Seal door on outside only (wall and between tray) to ensure watertight seal.

Adjustment: All doors are designed to run correctly. If this does not occur please make sure gaskets are fully slotted in or use hex nuts on back of top roller to get adjustment

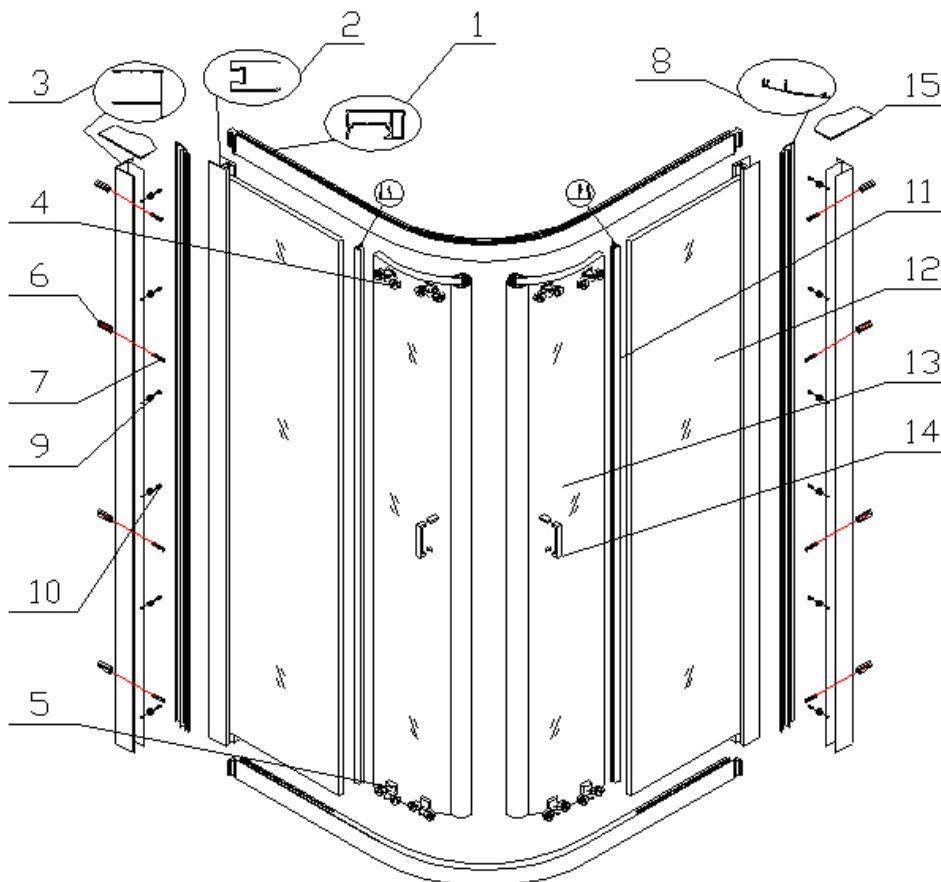

EASY FIT SYSTEM

