



PREMIUM **QUADRANT 1 DOOR** SHOWER ENCLOSURE  
**FITTING INSTRUCTIONS**



# IMPORTANT CHECKLIST

## Before installation - please ensure...

- 1: The walls are reasonably flat and that the shower tray is level, properly sealed, and drains correctly.
- 2: There is no pipe work or cables behind walls where drilling.
- 3: Shower door is the correct size for the shower tray (see measurements below) and you have allowed for tiles.
- 4: There is no visual defect to the shower door.
- 5: Proper fixings are used for the appropriate wall type.

# INSTRUCTION PRODUCT SIZES

These Instructions are specifically for the Duchy Quadrant 1 Door Shower Enclosure. Please Refer to the packaging to ensure that you have the one of the three sizes referred to in the table below...

Quadrant Tray Size	Dimensions (A) Min-Max	Dimensions (B) Min-Max
800mmx800mm	765mm - 795mm	765mm - 795mm
900mmx900mm	865mm - 895mm	865mm - 895mm
1000mmx1000mm	965mm - 995mm	965mm - 995mm

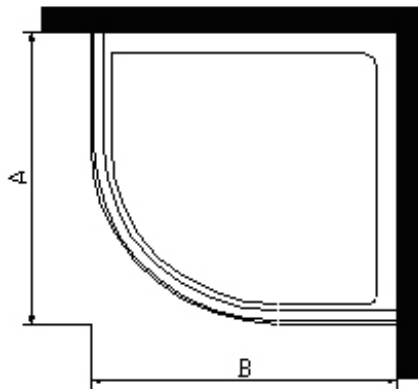

# PRODUCT PARTS

The following pictures show the parts and the quantities included for this product. Please ensure that these parts are included before you start installing...

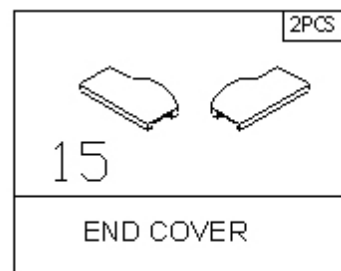
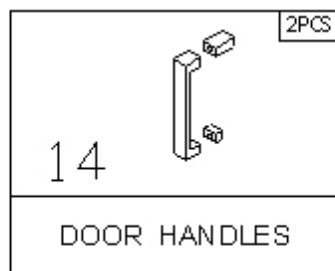
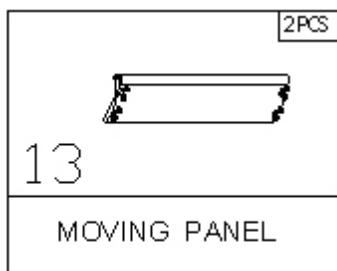
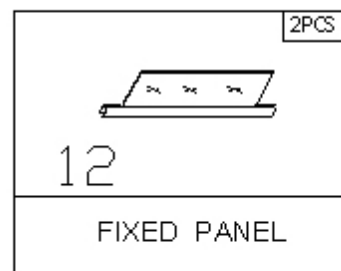
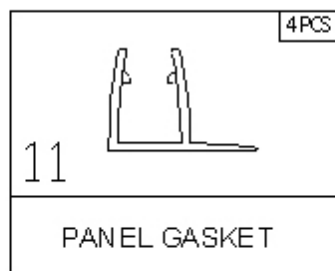
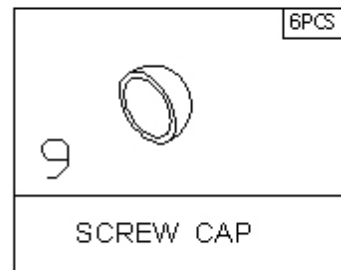
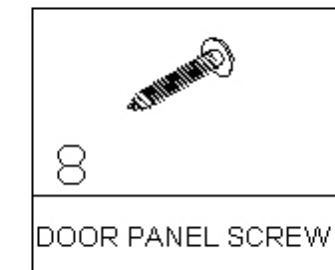
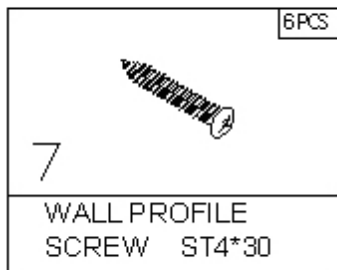
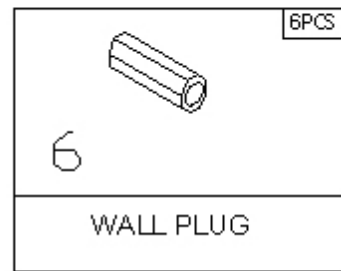
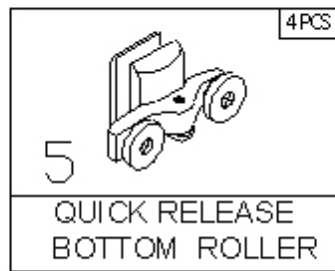
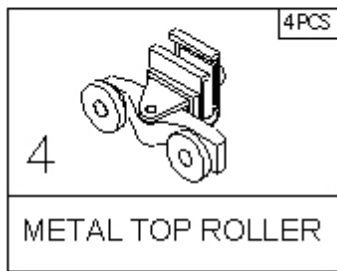
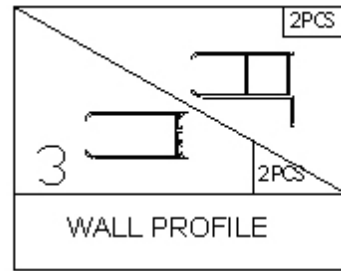
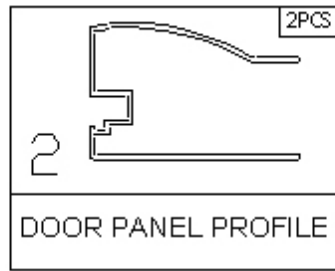
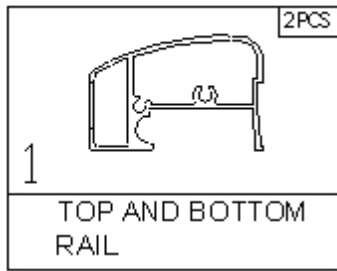

# INSTALLATION PROCEDURE DIAGRAMS

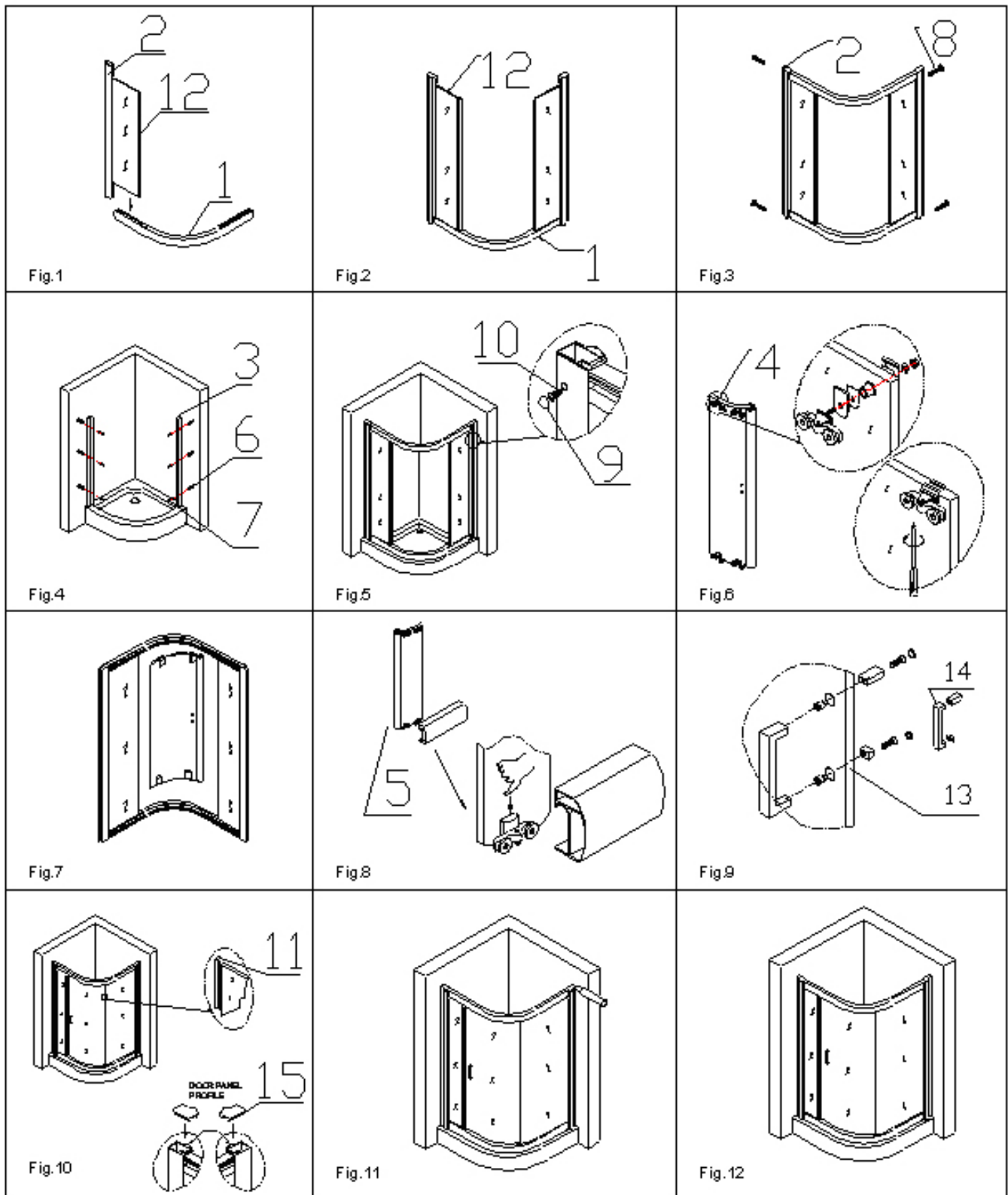

# INSTALLATION PROCEDURE INSTRUCTIONS

- 1: Install wall profiles level in upright position using screws No. 7 (see Fig. 4)
- 2: Build frame by attaching top and bottom profiles (No. 1) to fixed panels (No. 12) using fixing screws supplied (No. 8) securely on each corner make sure gaskets are fully inserted and pushed home as not fully inserted will result in doors not clip into position (see Fig. 3)
- 3: Hang the door onto top profile using adjustment to check for initial smooth running (No. 13), remove to fix frame to wall profiles (doors can be re-installed after frame is secured)
- 4: Fix frame to wall profiles using screws on inside (see Fig. 5)
- 5: Fix handles (No.14) to doors (see Fig. 9)
- 6: Hang the door onto frame and adjust for smooth running
- 7: Seal door on outside only (wall and between tray) to ensure watertight seal

**Adjustment:** All doors are designed to run correctly. If this does not occur please make sure gaskets are fully slotted in or use hex nuts on back of top roller to get adjustment

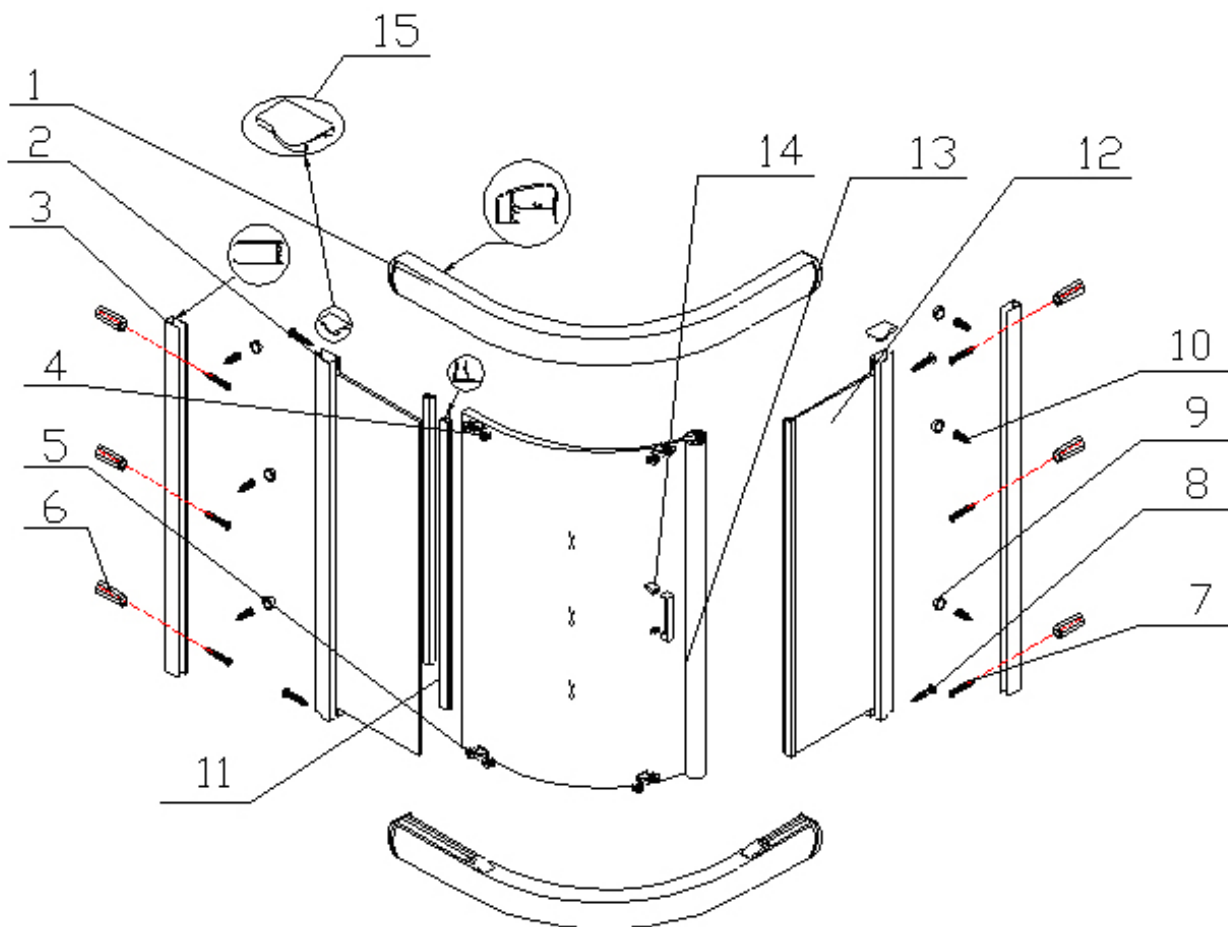

# EASY FIT SYSTEM

