

DUCHY

— STYLE —

WET ROOM GLASS PANEL INSTALLATION INSTRUCTIONS



PLEASE ENSURE:

- The walls are reasonably flat
- There is no pipe work or cables behind walls where drilling
- There is no visual defect on door(as claim will not be accepted after installation)
- Proper fixings used if cavity wall or other
- Please read instructions carefully, check amount of accessories and whether the shower door is in good condition and if there are any problems contact your supplier or our company.

COMPONENTS:

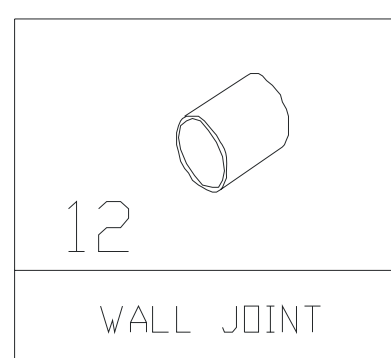
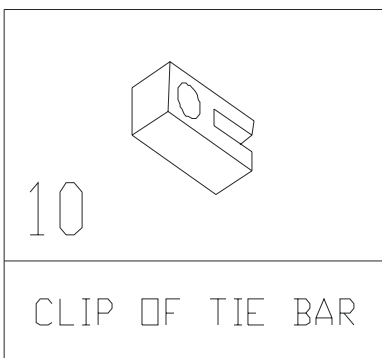
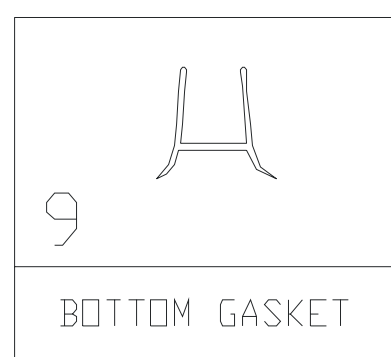
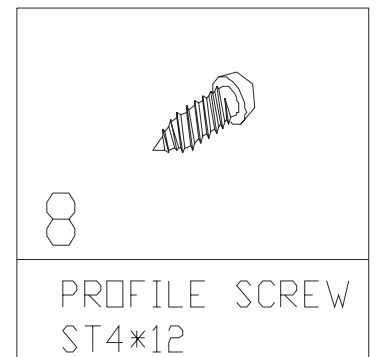
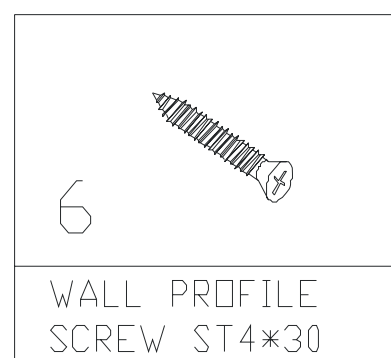
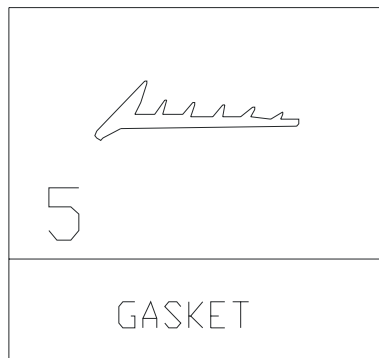
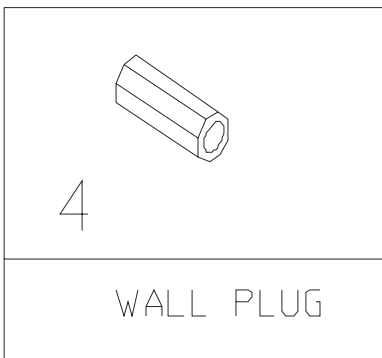
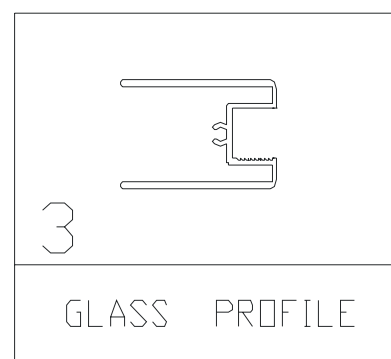
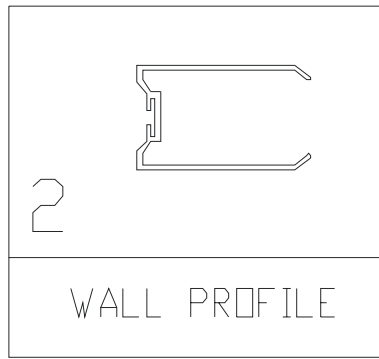
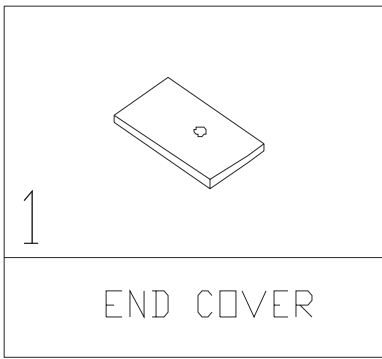

INSTALLATION OPTIONS I

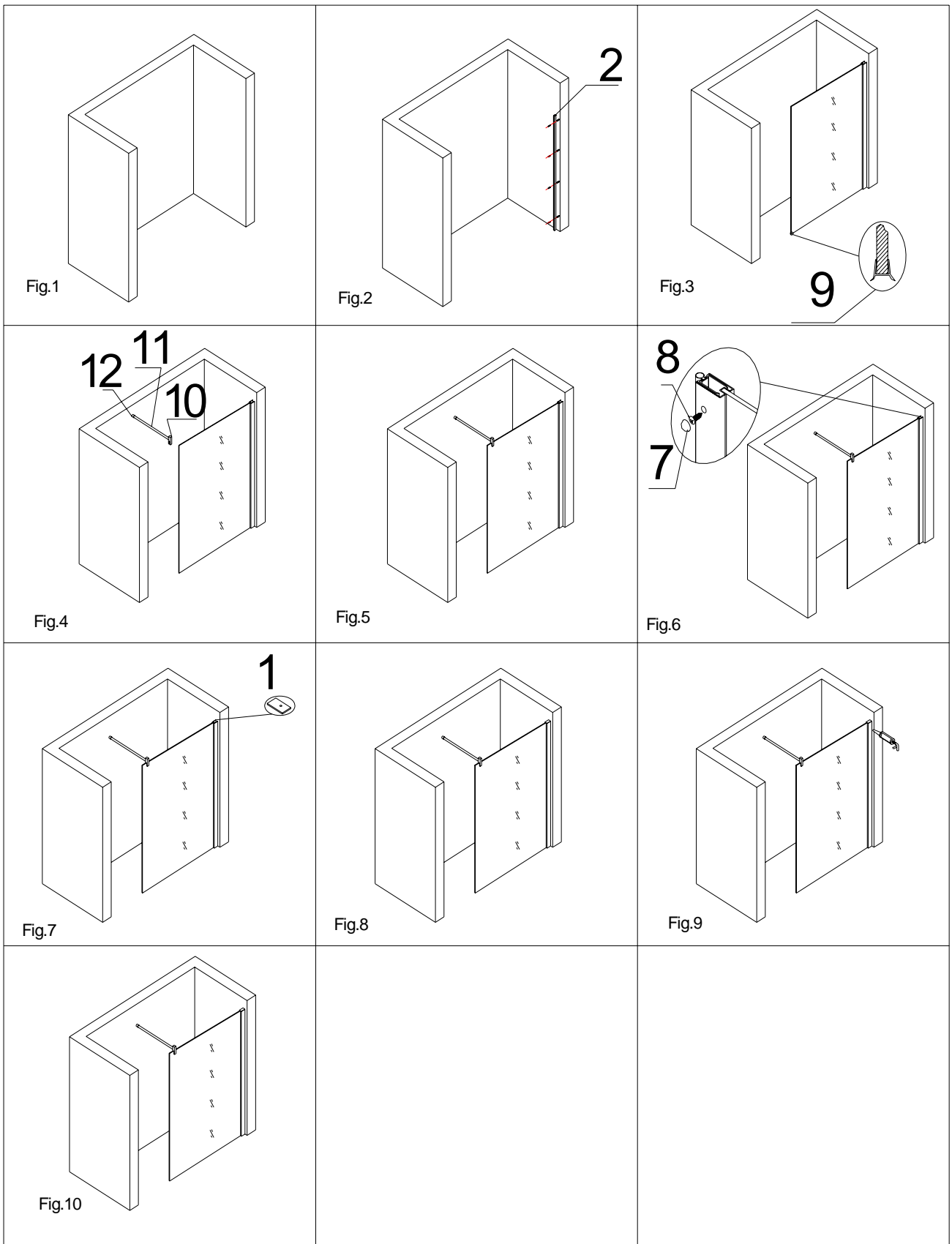

Make sure gaskets are fully slotted in

