

User' manual

CLAS HE

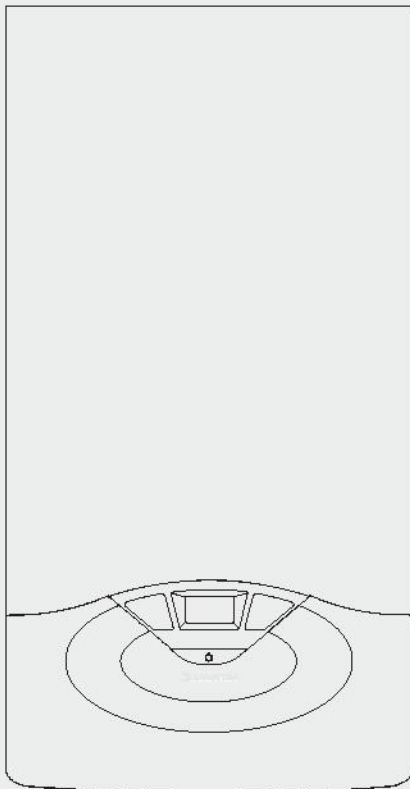

Condensing wall hung system boiler

G.C.N : 24 47-116-51 (24 kW)

G.C.N : 24 47-116-52 (30 kW)

G.C.N : 24 47-116-53 (38 kW)

CLAS HE 24

CLAS HE 30

CLAS HE 38



*The code of practice for the installation,
commissioning & servicing of central heating systems*

Dear Customer,

Thank you for choosing an ARISTON boiler. We guarantee that your boiler is a reliable and technically sound product. This manual provides detailed instructions and recommendations for proper installation, use and maintenance. Remember to keep this manual in a safe place for future reference i.e. by the gas meter. Your local MTS Servicing Centre is at your complete disposal for all requirements.

The installation and first ignition of the boiler must be performed by qualified personnel in compliance with current national regulations regarding installation, and in conformity with any requirements established by local authorities and public health organisations. After the boiler has been installed, the installer must ensure that the end user receives the declaration of conformity and the operating manual, and should provide all necessary information as to how the boiler and the safety devices should be handled.

This appliance is designed to produce hot water for domestic use. It should be connected to a heating system and a distribution network for domestic hot water, both of which must be compatible with its performance and power levels. The use of the appliance for purposes other than those specified is strictly forbidden. The manufacturer cannot be held responsible for any damage caused by improper, incorrect and unreasonable use of the appliance or by the failure to comply with the instructions given in this manual. Installation, maintenance and all other interventions must be carried out in full conformity with the governing legal regulations and the instructions provided by the manufacturer. Incorrect installation can harm persons, animals and possessions; the manufacturing company shall not be held responsible for any damage caused as a result. In the event of any maintenance or other structural work in the immediate vicinity of the ducts or flue gas exhaust devices and their accessories, switch the appliance off by switching the external bipolar switch to the "OFF" position and shutting off the gas valve. When the work has been completed, ask a qualified technician to check the efficiency of the ducting and the devices. If the boiler should be out of use for a prolonged period, it is recommended that the electrical power supply be disconnected and that the external gas cock be closed. If low temperatures are expected, the boiler and system pipe work should be drained in order to prevent frost damage. Turn the boiler off and turn the external switch "OFF" to clean the exterior parts of the appliance. Do not allow children or inexperienced persons to use the appliance without supervision.

CE labelling

The CE mark guarantees that the appliance conforms to the following directives:











- **90/396/CEE** relating to gas appliances
- **89/336/CEE** relating to electromagnetic compatibility
- **92/42/CEE** relating to energy efficiency
- **73/23/CEE** relating to electrical safety

GUARANTEE

The appliance is guaranteed for 24 months from the date of purchase. Aristons only obligation under the guarantee will be to repair or replace the faulty appliance at Aristons discretion. This will be carried out where the fault arises from within defects in the appliance, caused either by material or workmanship of the manufacturer. This guarantee does not protect malfunction or damage arising from incorrect installation, commissioning or maintenance procedures as laid out in the installation and servicing manual, inefficient flue system, poor or incorrect electricity, wrong gas supply or pressure, tampering by inexperienced persons and any other cause not directly due to manufacture. MTS (GB) Limited cannot accept responsibility for any cost arising from repair or maintenance carried out by any third party. Service under the guarantee does not affect the expiry date of the guarantee. The guarantee on parts and appliances which are exchanged ends when the guarantee on the original appliance expires. This guarantee does not affect your statutory rights. You must have your boiler serviced at the end of the first year to validate your guarantee for the second year.

Safety regulations

Key to symbols:

-  Failure to comply with this warning implies the risk of personal injury, in some circumstances even fatal
-  Failure to comply with this warning implies the risk of damage, in some circumstances even serious, to property, plants or animals. **Do not perform operations which involve opening the appliance.**
-  Electrocutation from live components. Personal injury caused by burns due to overheated components, or wounds caused by sharp edges or protrusions. **Do not perform operations which involve removing the appliance from its installation space .**
-   Electrocutation from live components. Flooding caused by water leaking from disconnected piping. Explosions, fires or intoxication caused by gas leaking from disconnected piping. **Do not damage the power supply cable.**
-  Electrocutation from live uninsulated wires. **Do not leave anything on top of the appliance.**
-  Personal injury caused by an object falling off the appliance as a result of vibrations. Damage to the appliance or items underneath it caused by the object falling off as a result of vibrations. **Do not climb onto the appliance.**
-   Personal injury caused by the appliance falling. Damage to the appliance or any objects underneath it caused by the appliance falling away from its installation space. **Do not climb onto chairs, stools, ladders or unstable supports to clean the appliance.**
-  Personal injury caused by falling from a height or cuts (step ladders shutting accidentally). **Do not attempt to clean the appliance without first switching it off and turning the external switch to the OFF position.**
-  Electrocutation from live components. **Do not use insecticides, solvents or aggressive detergents to clean the appliance.**
-  Damage to plastic and painted parts. **Do not use the appliance for any use other than normal domestic use.**
-  Damage to the appliance caused by operation overload. Damage caused to objects treated inappropriately. **Do not allow children or inexperienced individuals to operate the appliance.**
-  Damage to the appliance caused by improper use. **If you detect a smell of burning or smoke coming from the appliance, disconnect it from the electricity supply, turn off the main gas valve, open all windows and call for assistance.**
-  Personal injury caused by burns, smoke inhalation, intoxication. **If there is a strong smell of gas, turn off the main gas valve, open all windows and call for assistance.**
-  Explosions, fires or intoxication.



Auto Function

The AUTO function serves to optimise boiler performance, while maintaining an optimum radiator temperature and maximum user comfort. It ensures the building stays at the ideal temperature, whilst saving energy.

The principle is that the water temperature at the boiler outlet is automatically adjusted, depending on the interior ambient temperature.

Control Panel

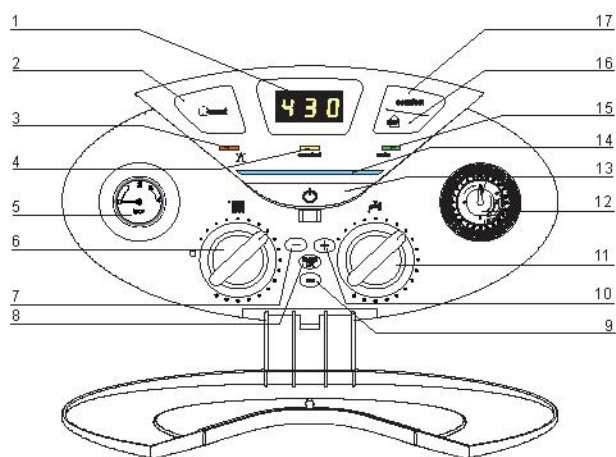

Legend :

1. Display
2. RESET button
3. Red indicator locking light
4. Orange indicator COMFORT fonction
5. Pressure gauge
6. Heating temperature regulation knob
7. button -
8. MENU/OK button (Programming key)
9. ESC button
10. button +
11. Domestic Hot Water adjustment knob
12. Time clock
13. ON/OFF button
14. Blue indicator burner ON
15. Yellow indicator AUTO fonction
16. AUTO button (To active Thermoregulation)
17. COMFORT button

Initial operating procedures

If the boiler is installed inside the apartment, make sure that all provisions relating to the air inlet and room ventilation (in compliance with current legislation) are respected.

Check the water pressure on the display regularly and make sure that the figure is between 0.6 and 1.5 bar when the system is cold. If the pressure is just under the minimum value the display will request a filling procedure.

Re-establish the correct pressure by filling loop.

If the pressure drops very frequently, there may be a water leak at some point in the system. If this is the case a plumber should be contacted.

Ignition procedure

Press the ON/OFF button on the control panel to switch on the boiler. The display shows:

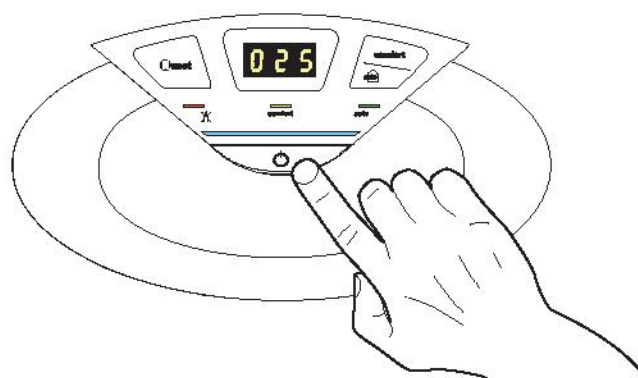

The first figure indicates the operating mode:

- 0 - Stand -by,
- C - Central heating request
- c - Heating post-circulation
- d - Domestic hot water request
- H - Hot water post-circulation
- F - Circulation pump anti-freeze protection enabled
- burner anti-freeze protection enabled

The second and third figures indicate:

- the flow temperature when no heating requests have been made
- the flow temperature in central heating mode
- the temperature of the hot water in domestic hot water mode
- the flow temperature in anti-freeze mode.

Winter or summer function

Turn the heating button **6** to select the desired operating mode (winter or summer). In winter mode every heating is shown on the display by the heating temperature.

Summer mode is set by putting the button **6** in \bigcirc position (heating off).

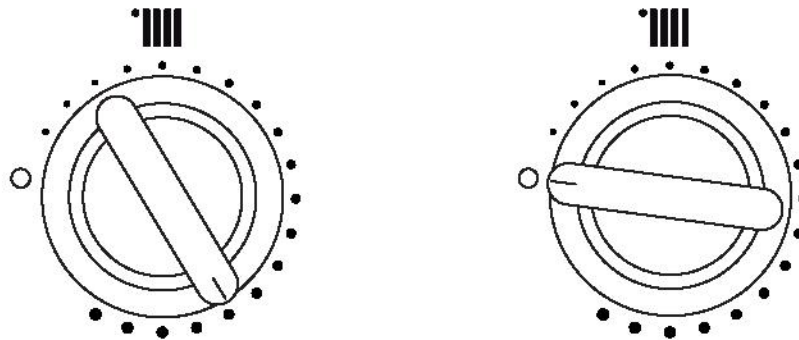

Adjusting the heating

It is possible to set the temperature of the heating water by adjusting the knob **6**. By placing the indicator somewhere between min. and max. a temperature may be obtained which varies from about 20°C to about 45°C (low temperature) and about 35°C to about 82°C (high temperature).

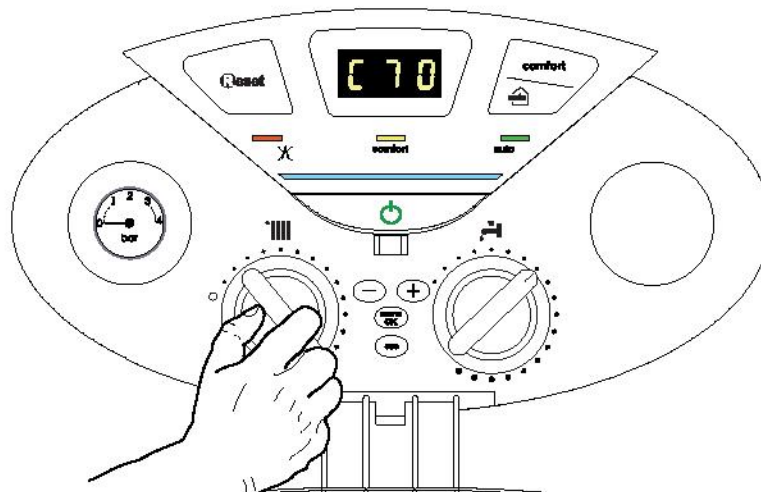

Domestic hot water temperature adjustment

It is possible to set the temperature of the domestic hot water by adjusting the knob **11** a temperature may be obtained which varies from about 36°C to about 60°C.

The value set previously will flash on the display.

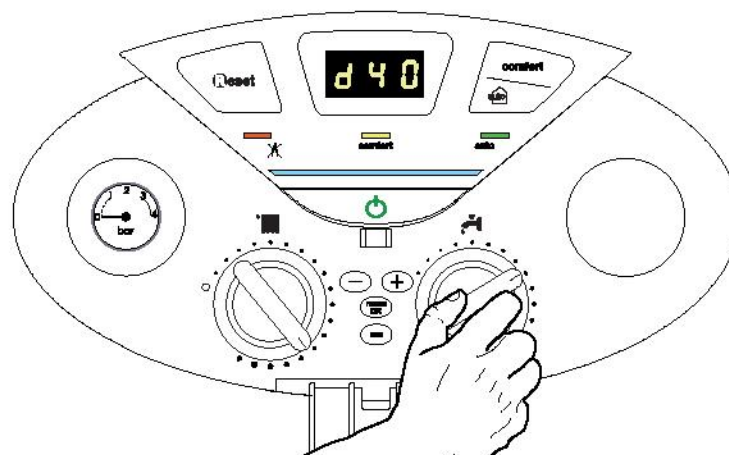

COMFORT function

To activate the comfort mode it is necessary to press the comfort button 17, this will be indicated by a yellow light 4. The comfort mode has priority over any other heating request.

There are two settings for the comfort mode (they can be adjusted in the parameters menu):

1. As soon as DHW is drawn, the secondary heat exchanger is kept warm for 30 mins.
2. As soon as DHW is drawn, the secondary heat exchanger is kept warm permanently.

This function may be enabled by pressing the COMFORT button.

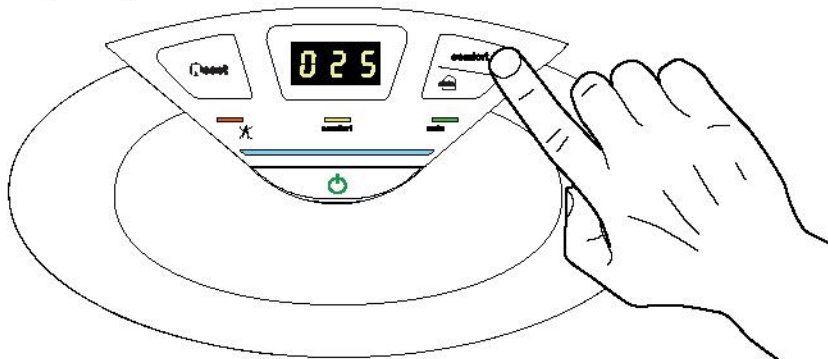

Switching off the heating

To switch off the heating mode turn the button 6 in the position

○. The boiler switches in sanitary mode only and indicating the set temperature.

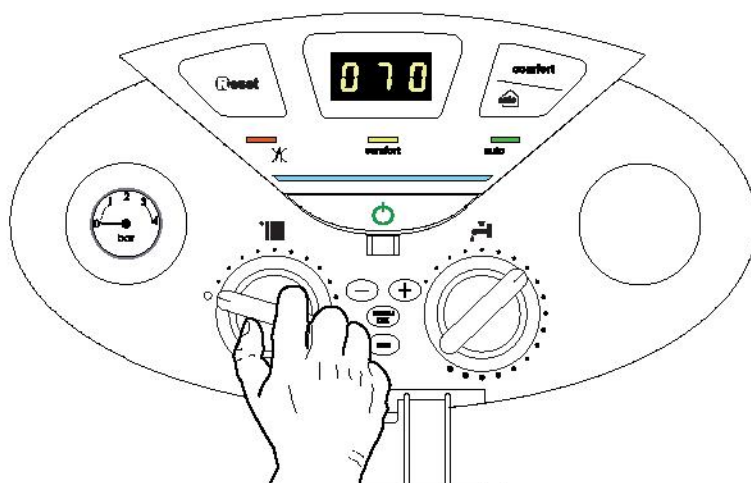

Stand by

To switch off the boiler press the ON/OFF 13.

Switch off the boiler completely by switching the external electrical switch to the OFF position; the display will switch off.

Close the gas tap.

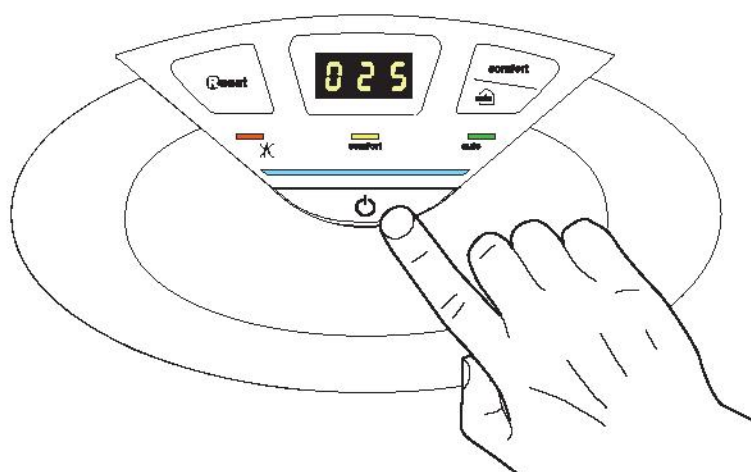

Appliance shut-off conditions

The boiler is protected from malfunctions by means of internal checks performed by the electronic P.C.B, which stops the boiler from operating if necessary. In the event of the boiler being shut off in this manner, a code appears on the control panel display which refers to the type of shut-off and the reason behind it. Two types of shut-off may occur:

Safety shut-off

This type of error is "volatile", which means that the boiler starts up again automatically as soon as the problem which caused the shut-off is removed. The display will flash "Err" and the error code.

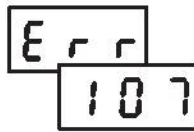

In fact, as soon as the cause of the shut-off disappears, the boiler starts up again and continues to operate normally. While the boiler is shut off for safety reasons, it is possible to attempt to restore normal operation by switching the appliance off and on again using the ON/OFF button on the control panel. If the boiler still indicates a safety shut-off, switch it off. Make sure the external electric switch is in the OFF position, close the gas tap and contact a qualified technician.

Safety shut-off due to insufficient water pressure

If the water pressure inside the heating circuit is insufficient, the boiler will perform a safety shut-off. (See table). To re-pressurise the boiler, it will be necessary to connect the silver flexible hose supplied to the two isolating points underneath the boiler, once the hose is connected, open up both of the black quarter turn handles, once the pressure reads 1.5 bar on the display, close both handles and disconnect the hose. If the pressure drops very frequently, there may be a water leak at some point in the system. If this is the case please contact your installer and ask them to check it.

Operation shutdown

This type of error is "non volatile", which means that it is not removed automatically. The display will flash ERR and the error code and the red led lights up "3" . In this case the boiler does not restart automatically, but it may be reset by pressing the **Reset** button. If the problem manifests itself again after several attempts to reset the appliance, contact a qualified technician.

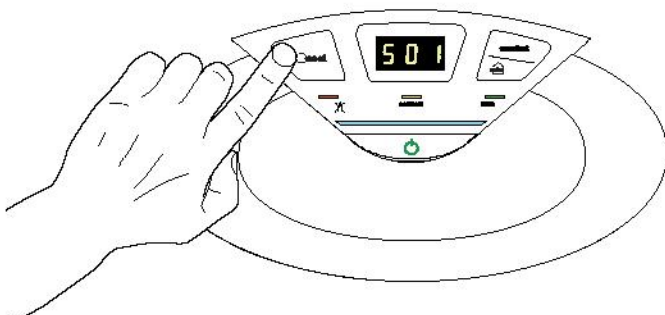

IMPORTANT
IF THIS SHUTDOWN OCCURS FREQUENTLY, CONTACT AN AUTHORISED SERVICE CENTRE FOR ASSISTANCE. FOR SAFETY REASONS, THE BOILER WILL ALLOW A MAXIMUM OF 5 RESET OPERATIONS TO TAKE PLACE IN 15 MINUTES (INDIVIDUAL PRESSES OF THE **Reset BUTTON).**

Operation shutdown error table

Display	Description
1 01	Overheating
5 01	No flame detection
1 03	Insufficient circulation
1 04	
1 05	
1 06	
1 07	
3 05	P.C.B error
3 06	P.C.B error
3 07	P.C.B error

Anti-frost Device.

The anti-frost function acts on the central heating flow temperature probe, independently from other settings, when the electrical supply is turned on. If the primary circuit temperature falls below 8°C the pump will run for 2 minutes. After the two minutes of circulation (fixed) the boiler will check the following:

- a) if the central heating flow temperature is > 8°C, the pump stops;
- b) if the central heating flow temperature is between 4 and 8°C, the pump will run for another two minutes;
- c) if the central heating flow temperature is < 4°C, the burner will fire (heating position) at minimum power until the temperature reaches 33°C, the burner will go off and the pump will continue to run for two minutes.

The anti-frost device activates only when (with the boiler operating correctly):

- the system pressure is correct,
- the boiler is electrically powered,
- there is a supply of gas.

Auto button - Temperature adjustment activation

The AUTO function enables boiler operation to be adapted to environmental conditions and to the type of system it is installed on.

Comfortable temperature is reached inside the room in the quickest way possible, without wasting money, energy or efficiency, while substantially reducing the amount of wear experienced by the components.

Your installer will advise you on the devices connectable to the boiler and will program it according to the system.

In normal boilers the water temperature inside the heating elements is usually set to a high value (70-80°C), thereby ensuring effective heating during the few really cold winter days. It then becomes excessive on less cold days (of which there are many) more typical of the autumn and winter seasons. This leads to excessive room heating after the thermostat has been switched off, resulting in energy waste and uncomfortable conditions inside the room.

The AUTO function "takes control" of the boiler and selects the best operating regime based on environmental conditions, external devices connected to the boiler and the performance required. It constantly decides at which power level to operate based on the environmental conditions and the room temperature required.

Change of gas type

Our boilers are designed to function either with Natural Gas (methane) or L.P.G. gas. If you need to change from one gas to the other, one of our Authorised Service Centres must be contacted to convert the appliance.

Maintenance

Schedule an annual maintenance check-up for the boiler with a competent person.

Correct maintenance always results in savings in the cost of running the system.

Failure to arrange an annual service for the appliance will invalidate the second year of the manufacturers guarantee.



Commercial subsidiaries:

MTS (GB) Limited
MTS Building
Hughenden Avenue
High Wycombe
Bucks HP13 5FT
Telephone: (01494) 755600
Fax: (01494) 459775
Internet: www.mtsgroup.com/uk
E-mail: info@uk.mtsgroup.com
Technical Advice: 0870 241 8180
Customer Service: 0870 600 9888

MTS Heating Limited
Damastown Industrial Park
Damastown Avenue
Mulhuddart
Dublin 15
Telephone: (01) 810 3723
Fax: (01) 810 3727
Internet: www.mtsgroup.com/ie
E-mail: info@ie.mtsgroup.com
Technical Advice: (01) 437 0121
Customer Service: (01) 437 0121