





Dune - 1.0 Bowl & Drainer

Reversible - Black Metallic Granite

abode

	Abode code:	AW3140-1
	EAN 13 Barcode:	5060344153980
	Specification version:	0
	Finish:	

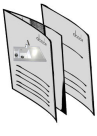
Included parts:				
 <p>1 x AX1002 (m) 90mm (1.5") Orbit manual basket strainer waste - long bolt</p>	 <p>1 x AX1007-1 (m) Round overflow pipework</p>	 <p>1 x AX1008-1 (m) 1 Bowl Pipework</p>	 <p>1 x AX1033 (m) Composite inset fixing clips x 8</p>	 <p>AX4004 (m) Fitting & care instructions & data sheet - coloured inset</p>

Compatible parts / accessories:				

Packing summary:	Materials & workmanship warranty summary:	Care instructions summary:
<ul style="list-style-type: none"> • Packaging Type: Boxed • Packaged size L x W x D: 1100 x 600 x 300mm • Boxed weight: 21.3kg 	<ul style="list-style-type: none"> • Sink materials & workmanship 10 years. • Waste kits 1 year. • Connecting pipework 1 year. 	<ul style="list-style-type: none"> • Clean the products regularly using soapy water and a non-abrasive cloth, regular cleaning will prevent the build-up of lime scale and dirt. • Avoid contact with corrosive or abrasive substances. • After cleaning rinse thoroughly with clean water then dry, for more detail see supplied booklet or www.abodedesigns.co.uk

Mounting Dimensions:						
Type of Installation:	Installation type recommended (true) or not?	Recommended minimum base unit mm (20mm wall thickness)	Overall recessed fitting width mm (required for bowl(s), tap hole, overflow)	Cut out size (length x width x corner radius mm)	Minimum - Maximum worktop thickness mm	Additional fitting notes
Inset	true	600	507	980 x 480 x R90	27 - 45	
Undermount			507			
Flushmount			507			
Apron front			507			

Product dimensions and installation information:



Note: symbol indicates position of acoustic pad on stainless steel sinks only
Overall product size: 1000 x 500 x 217, 100mm corner radius



***Important, fabricator / installer notes for undermount & Flushmount sinks:**

The cut out size indicated is aligned with outside edge of the bowl top radius (similar to the example below).

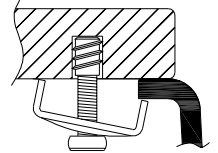

You should confirm with your client if the work surface cutout is to be cut flush, inside or outside this suggested perimeter shape & size.

If you create the cutout smaller or larger than the indicated size then the fit of the accessories may be affected and should be physically checked.

General:

All details are provided in good faith but do not include the tolerances of the material or manufacturing process.

We request that a test cutout is made in scrap timber and checked against the actual sink to be installed before committing to cutting the final work surface.

Abode can not accept liability for problems or costs incurred by failure to follow this request.

Note: the dimensions on ceramic fireclay products are subject to wider tolerances due to the nature of this natural material and the firing process.

CAD cutout files can be downloaded from www.abodedesigns.co.uk

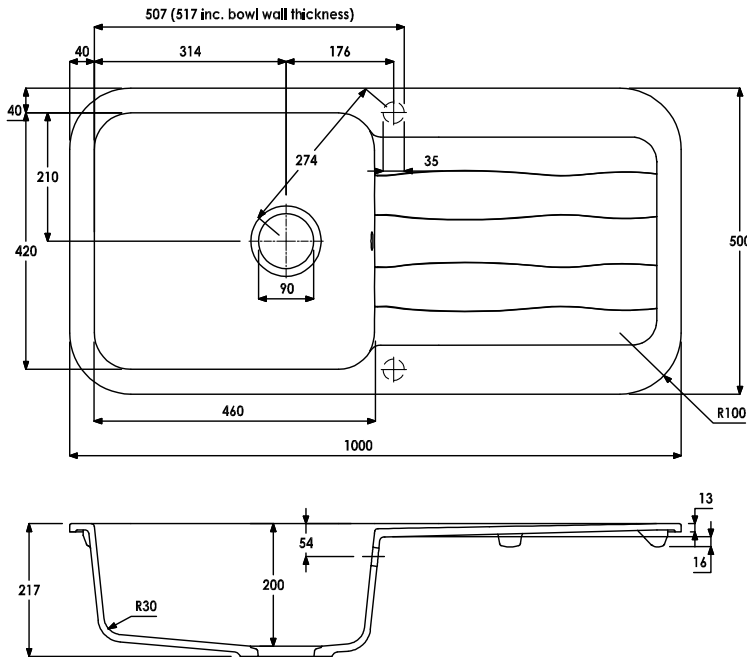

INSET CUT OUT

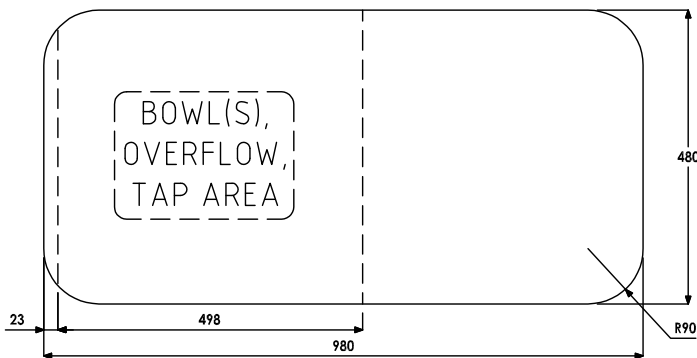

Additional notes:

Repeated release of boiling hot water directly into coloured sinks can in extreme cases cause crazing and even cracking. Therefore we recommend great care is taken not to release the water directly on to the sink surface at full temperature.

Bowl & drainer details:	Bowl 1 (typically main bowl):	Bowl 2: (typically ½ or ¾ or 2nd main bowl):	Bowl 3:	Drainer (left)	Drainer (right)
Bowl Size Width x Length x Depth x Radius (mm)	460 x 420 x 200 x 60				
Bowl floor radius (mm)	30				
Wastehole diameter (mm)	90				
Overflow type	Circular, 30mm diameter				
Wall thickness (gauge mm)	11			11	
Bowl texture / finish	Matt textured			Matt textured	
Bowl volume (apx. litres)	22.9				

