

Important Technical Data

Whilst every effort has been made to make these instructions comprehensive they may not be exhaustive, and we strongly recommend that this product is installed by a skilled professional. This will ensure the best possible finished installation.

This product is made from a mixture of acrylic resin and aggregate particles for the greatest possible durability, after the end of the lifecycle of this product it should be disposed of responsibly.

Earth bonding: under current IEE regulations there is no statutory requirement to earth bond sinks as most new wiring installations are protected with an RCD. If you are unsure whether your wiring is protected by an RCD, contact a qualified electrician.

Maximum temperature 280°C* Note: If this temperature is exceeded, even for short periods, damage to the finish can result.

Waste disposers should be mounted in such a way that the weight of the unit is supported by the kitchen cabinet carcass, not just the sink. Faulty or damaged waste disposal units can cause vibration – this will damage the sink and can loosen connecting pipework or fixings causing water leaks.

All Abode products are designed in accordance with recognised European or global standards. Please ensure that your Abode product is fitted in accordance with localised legislation.

The installation should be periodically checked for damage to water sealing parts as described in the instructions to avoid accidental water damage.

Abode is a registered trademark of Abode. All errors and omissions excepted.

A full technical specification and copies of these instructions are available for this product on our website. www.abodedesigns.co.uk

Manufacturers Product Reference



Norcros Group (Holdings) Ltd
Ladyfield House
Station Road,
Wilmslow
Cheshire
SK9 1BU

Production year: See label

Abode DoP

Product code: See label

Preparation of food, washing of
dishes and discharge of
domestic wastewater.

EN 13310

CA - DA

©Abode
AX4017 v3 - 10/2016



Unit L, Zenith Park, Whaley Road, Barnsley, S75 1HT.
Tel: 01226 283434 Fax: 01226 282434

www.abodedesigns.co.uk

All errors and omissions excepted.

Composite Inset/ Undermount Sink



10 Year Warranty Terms and Conditions

In the unlikely event that you should experience any defect in the materials or workmanship of your new Abode sink within 10 years of purchase, the manufacturer will repair or replace all or any part of the product that is defective, at their discretion. The manufacturer will not be responsible for any other consequential costs such as labour, removal or reinstallation of the sink or any other connected or related products.

This is provided that the product has been used for normal domestic purposes in the UK & Eire, and that the care, installation and maintenance instructions have been observed. The warranty extends to the original purchaser only. You should retain a copy of your dated invoice as proof of purchase to validate any claims under this guarantee.

Please note that this product is manufactured using natural materials so slight shade variations can occur. Marks, scuffs and scratches caused during installation or

Care Instructions for your Kitchen Sink

To maintain the appearance of this product, ensure that it is regularly cleaned using only a clean, soft damp cloth. A solution of warm water and a mild liquid non-antibacterial detergent may be used where necessary, and then the product rinsed thoroughly and wiped dry. Any other cleaning action will invalidate your warranty.

No household or industrial chemicals should come into contact with this product to prevent damage. To prevent staining or discolouration of the product always rinse the sink with water after use, if you live in a hard water area we suggest you also wipe the sink dry.

Repeated release of boiling hot water directly into coloured sinks can in extreme cases cause crazing and even cracking. Therefore we recommend great care is taken not to release the water directly on to the sink surface at full temperature.

Do not cut, slice or chop directly onto the sink as you may mark the surface finish. Avoid the use of plastic washing up bowls as engrained grit on the bowl underside may mark the surface finish. Avoid impacting the product with sharp or heavy objects, such as knives, pans or cooking pots and also avoid contact with abrasives. No hot objects should be placed directly onto the sink surface. Avoid contact with cycles of very hot and cold substances.

For further care and maintenance advice on removing stubborn marks and more examples of objects or actions likely to artificially shorten the life of this product please visit our website.

accidental damage are not covered by this guarantee. Neither are stains, discolouration or corrosion or any damage or defect caused by incorrect installation or abuse of the product.

We are continuously improving and developing our range of products, finishes & colours. Therefore, in the event of a valid claim, we may not be able to provide an identical replacement for the defective product throughout the guarantee period. Where an identical product is no longer available, we will supply the nearest equivalent from our then current product range. In assessing your claim, we must be given the opportunity to inspect the product as installed prior to removal. Any product returned to us must be securely packaged and adequately insured. We will not accept responsibility for any damage caused during transportation.

No installer, dealer, agent or employee of Abode has the authority to modify the obligations or limitations of this warranty. This warranty does not affect your statutory rights.

Please retain these instructions with the sink for future reference

Please retain these instructions with the sink for future reference

Parts and Contents

Key	Description	Qty
A	Sink (may differ from model shown)	1
B	Overflow, wastes and pipework	See included specification sheet
C	Care instructions and cut-out sizes	1 (dependant on model)
D	Undermount brackets, bolts and inserts	See included specification sheet

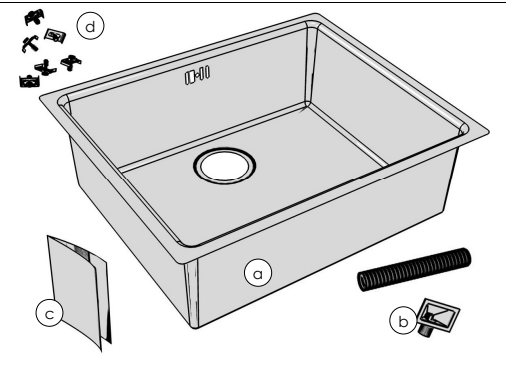

Installation Instructions Inset

Follow cut out instructions provided, connect overflow and pipe work as instructed. No inset clips are provided so silicone seal around rim of underside of sink then place onto work surface. Note: Place a heavy object inside bowl to press sink down to help to keep the sink in place whilst the silicone sets.

Installation Instructions Undermount

Preparation

- Take great care when handling this sink. Whilst every effort has been taken to remove sharp edges, the material by nature may be sharp. We recommend wearing gloves accordingly. Do not lift the product by the waste hole(s) or tap hole(s).
- Check the package for completeness, possible defects or any transport damage before installation commences. Installed faulty product will not be honoured by the warranty.
- Check that the supporting carcasses and worktop is level left to right and front to back to ensure the correct drainage of water.
- Check that the surrounding furniture is the correct size and shape to accept this product and that no plumbing or wiring may foul the installation.
 - We recommend that all undermount products should be supported under the reverse face with a substantial braced shelf similar to the example below (when full the sink could weigh up to 40kg). The shelf should allow for small adjustments in height at each corner and so that it could be disassembled from the underside in the event that the sink is accidentally damaged.
 - The height of the shelf should be such that when the sink is placed on the shelf the top face rim of the sink is level with the underside face of the worktop, see the example below.

Key	Description
A	Surrounding cupboards or end panels
B	Hole for waste connections (min. recommended dia. 150mm for each waste, centred to waste position)
C	Supporting shelf (moisture resistant timber or similar, ensure framework sits directly under the product)
D	Incoming hot and cold supply pipes
E	Supporting uprights (front & back)

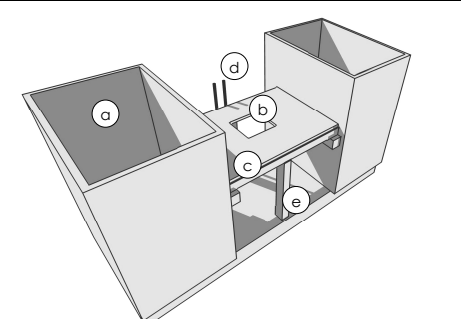

- If replacing an existing sink, remove this product and clean the surrounding area, ensure the new sink will suit the existing cut-out size and position, otherwise amend the cut-out size accordingly.
- Collect the tools you will need to complete this installation.

Installation

- Before creating the cut-out in the worktop carefully plan the positioning of the sink. Ensure that the position of the bowl(s), tap and overflows will not interfere with surrounding units or appliances. The cut-out details are published on the included specification sheet and are downloadable as CAD file at www.abode.eu to ensure perfect positioning of this product. Check that the fixing clips will not foul carcass walls or supporting braces.

- Carefully mark out the cut-out using the provided cut-out drawing or template. Create the sink cut-out in the worktop using a router or CNC cutter, follow the manufacturers instructions and take care not to chip, crack or scratch the worktop. If preparing the cut-out in situ cover any open pipework to avoid any debris contaminating the water supply feeds.

IMPORTANT: Due to the hand finished dimensional tolerances of our products we strongly recommend making the cut-out in a scrap piece of material then offering it against the actual sink to be fitted. The cut-out size should be adjusted to suit the sink tolerances and retested against the intended product before committing to cutting the final worksurface. **The 'nominal' suggested cut-out size will align the cut-out edge with the bowl edge outer radius.** The offset from the bowl can be adjusted to overhang or be set back according to personal taste but this may interfere with installation or the correct usage of sink accessories.

- When creating the cut-out aperture you should also create a series of holes in the reverse face of the worktop to accept the undermount bracket inserts. The holes should be sized and positioned away from the edge of the sink as shown in Fig 1. All brackets supplied should be used and spaced equally around the perimeter. Where the sink has long and short sides more brackets should be used on the longer sides. Note: Suggested $\varnothing'A' = 8\text{mm}$ (wood or similar) else $\varnothing'A' = 10\text{mm}$

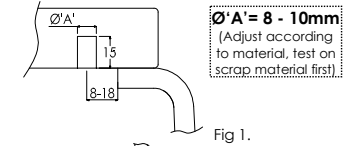

- Fill the reverse face bracket holes with 2 part epoxy adhesive. Push (non wooden worktops) or screw (wooden worktops) the inserts fully into the holes, let the adhesive cure before any further assembly. Note: If screwing in the inserts; use the bolt inside the insert to help drive the insert in, as shown in fig 2. Unscrew the bolt once the insert is securely in the hole leaving the insert behind.

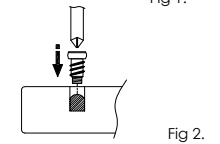

- Install the tap to the worktop according to the manufacturer's instructions. Ensure the tap is secure as later access may be obstructed by the sink or plumbing. We recommend long flexible tap connectors to help future maintenance.

- Install the basket strainer waste kit(s) and overflow(s) according to the manufacturer's instructions.

- Clean the outside rim of the sink and the worktop underside to remove any dirt or grease, allow to dry. Apply a continuous generous bead of good quality silicone onto the rim around the upper perimeter of the sink as shown in fig 3.

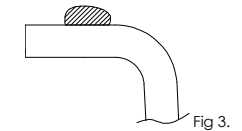

- Place the sink down squarely onto the rear face of the worktop and flush to the cut-out edge. Using the 'U' shaped brackets and bolts loosely clamp the sink to the worktop underside as shown in fig 4. Tighten the brackets in an order similar to that shown in fig 5. From the top face of the worktop check that the sink position is aligned to the cut-out before tightening the 'U' brackets down fully.

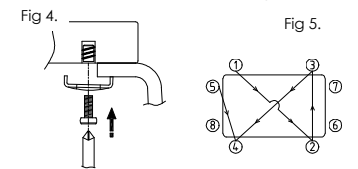

- Place the worktop, sink and tap carefully onto the kitchen carcasses. Where possible apply a 2nd bead of silicone around inside of the sink and worktop joint as shown in Fig. 6. Any excess silicone can be cleaned away using a proprietary silicone cleaner. Allow the silicone to dry.

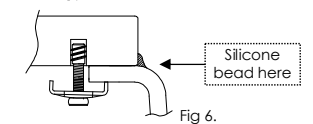

- Adjusting the supporting shelf at the corners to ensure the weight of the sink is supported but that it does not exert pressure on the worktop causing it to flex or bow upwards.

- Attach the sink connecting pipework to the waste kit(s) according to the manufacturer's instructions.

After installation

- Clean the sink using the attached care advice ready for use.
- Check the sink is flat to the worktop, straight and level; pour a small amount of water onto the drainer (if applicable) to check for drainage.
- Close the plug(s) in all bowls, fill the sink with water below the overflow and check the water does not leak through or around the waste(s).
- Close the plug(s) in all bowls fill the sink with water above the overflow, check the water exits though the overflow and does not leak from the overflow system.
- Open the plug(s) and let water drain from the bowls, check the connecting pipework does not leak.
- If the sink is not to be used for a period after installation, cover the sink and tap to protect them from accidental damage during further surrounding installation work.
- We recommend once fully set, the silicone seal should be checked for water tightness and rechecked periodically.