

Tuff Form[®] Former

Issue 1 November 2016

Product overview

Tuff Form[®] wet floor former used to create a contemporary wet room.

Care features

- + Suitable for both wooden and concrete installations
- + Work with gravity and pumped wastes
- + Nine sizes available to suit most installation requirements
- + Tuff Form[®] formers are trimmable on 3 sides up to 150mm from the waste area
- + The ribbed design on the underside eliminates slippage or float during installations
- + Threshold strip available
- + Bluetooth Smart wireless remote control (optional)

Benefits

- + Huge choice, so you can create the bathroom you want
- + Stylish, modern designs to give you attractive yet comfortable surroundings
- + Easy to install
- + Superior strength and rigidity, ideal for fitting under the bath in multi-tenant dwellings

Guarantee and Certification



Tuff Form[®] with Level Best screen

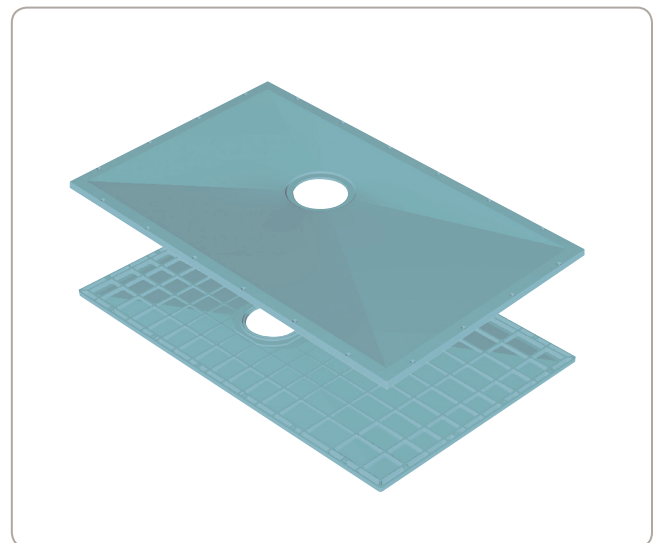

Specifier's Guide:

Height of Tray	Wood Floor	Concrete Floor	Screeded Floor	Corner Fitting	Alcove Fitting	Tray Handling	Gravity Waste	Pumped Waste
22 mm	Complete Level Access	✗	Complete Level Access	✓	✓	Non Handed	✓	✓

* The lifetime warranty excludes normal wear and tear in general applications and in accordance with AKW installation instructions. It applies only to products being installed for the first time and according to relevant local and national regulations.

Tuff Form® Former

Issue 1 November 2016

Production Specification:

- + Formed from compressed GRP for exceptional strength and stability (Tuff Form® former)
- + Due to the compressed GRP the former can be trimmed up to 150mm from the waste without losing strength integrity
- + Compatible with many AKW waste options, for a stylish look and easy installation: SS-TF75, SS-PGTF, SS-TFWA, TF75 Bath to tray adaptor, TF75 Bottom Outlet
- + Pumped waste options available: PGTF 15mm and 22mm options
- + 22mm depth
- + Pre-formed fixing holes
- + Offset waste position to avoid joists pipework
- + Maximum weight capacity 60 stone / 381kg
- + Tuff Form® is the first product in its market sector to have a carbon footprint assessed to the PAS 2050 specification and has undergone verification by the Carbon Trust
- + Tuff Form® has achieved a European Fire Safety Rating of CFI-s2
- + Tuff Form® is 5 times more durable than recycled plastic formers when side transferring a 60 stone person, avoiding possible replacement 5 times in the same life cycle
- + Tuff Form® will not warp or be deformed by temperatures reached in a normal bathroom situation (and has been tested to 100°C)
- + The waffle underside of Tuff Form® makes it easier to settle into a screeded installation than a smooth underside, which can slide around during installation
- + Tuff Form® is designed to provide a 'Bathroom for Life'
- + Fully recyclable - made from reusable GRP
- + In the event of needing to recycle a Tuff Form®, it is 100% recyclable at any local plant
- + A recycled Tuff Form® creates a Grade 1 material which can be used in ANY glass reinforced products
- + Hundreds of thousands of Tuff Forms® have been installed across the world
- + Tuff Form® is widely used in the US and has been tested to ANSI Z124.1.2-2005

Product codes

21000	Tuff Form® 900 x 900 former only
21008	Tuff Form® 1000 x 1000 former only
21012	Tuff Form® 1135 x 770 former only
21018	Tuff Form® 1200 x 1200 former only
21027	Tuff Form® 1300 x 820 former only
21028	Tuff Form® 1400 x 900 former only
21036	Tuff Form® 1500 x 820 former only
21045	Tuff Form® 1500 x 1200 former only
21050	Tuff Form® 1800 x 820 former only

- + Tuff Form® Former with TF75 wastes kits available.
- + Tuff Form® Former with waste adaptor and standard waste kits available

Issue 1 November 2016

Tuff Form® – 900 x 900

Compatible Level Best® glass shower screens:

GA GB

Compatible Silverdale® shower screens:

EW HFW

Compatible Wet Floor shower screens:

EW HFW HW

Compatible Sliding shower screens:

SE SM

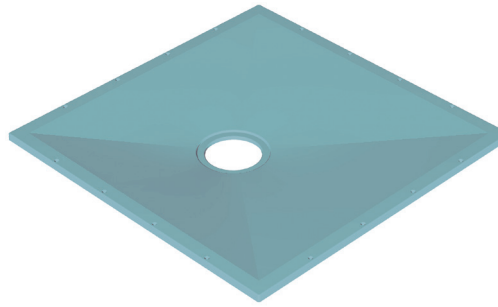

Former only code: 21000

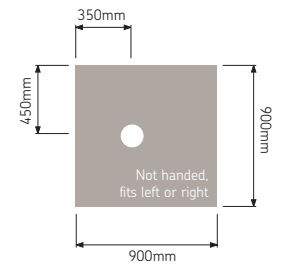

Tuff Form® – 1000 x 1000

Compatible Level Best® glass shower screens:

GA GB

Compatible Silverdale® shower screens:

EW HFW

Compatible Wet Floor shower screens:

EW HFW HW

Compatible Sliding shower screens:

SE SM

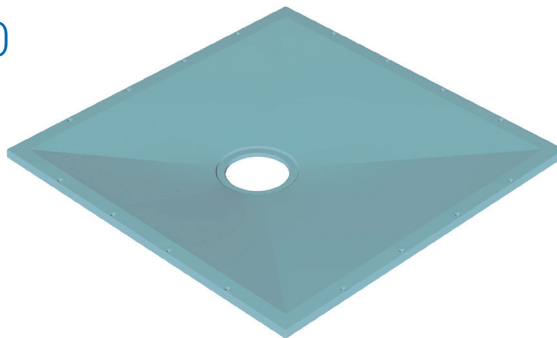

Former only code: 21008

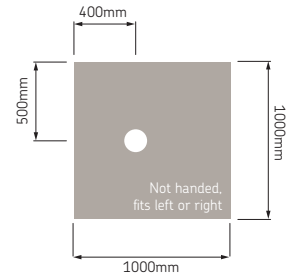

Tuff Form® – 1135 x 770

Compatible Level Best® glass shower screens:

GA GB

Compatible Silverdale® shower screens:

EW HFW

Compatible Wet Floor shower screens:

EW HFW HW

Compatible Sliding shower screens:

N/A

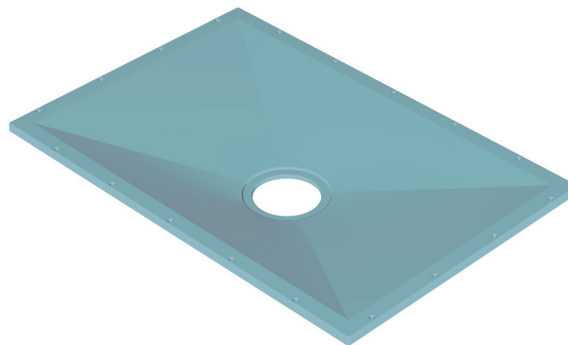

Former only code: 21012

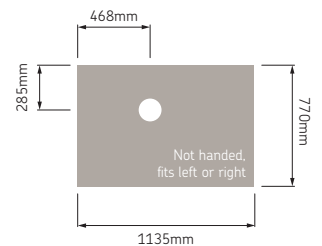

Tuff Form® – 1200 x 1200

Compatible Level Best® glass shower screens:

GA GB

Compatible Silverdale® shower screens:

EW HFW MW

Compatible Wet Floor shower screens:

EW HFW HW MW

Compatible Sliding shower screens:

SJ SM SN SU

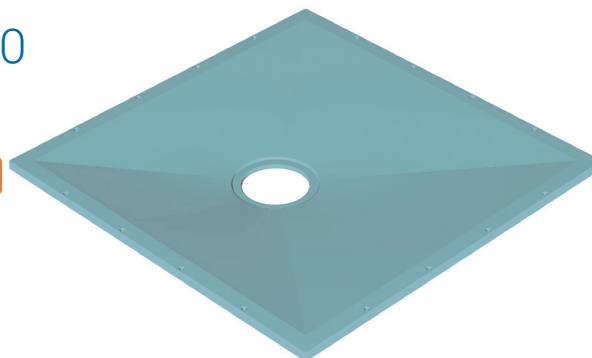

Former only code: 21018

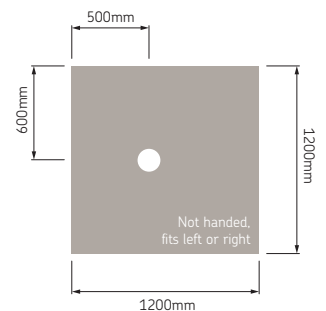

Tuff Form® – 1300 x 820

Compatible Level Best® glass shower screens:

GA GB

Compatible Silverdale® shower screens:

EW HFW NW

Compatible Wet Floor shower screens:

EW HFW HW NW XW

Compatible Sliding shower screens:

SE SJ SM SN SU SX SY

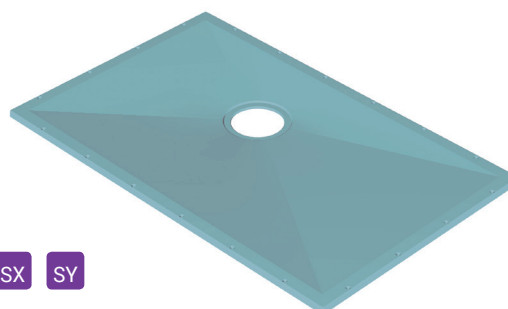

Former only code: 21027

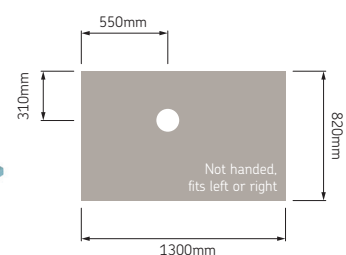

Tuff Form[®] – 1400 x 900

Compatible Level Best[®]
glass shower screens:

GA GB

Compatible Silverdale[®]
shower screens:

EW HFW NW

Compatible Wet Floor
shower screens:

BW EW HW HFW NW

Compatible Sliding
shower screens:

SJ SM SN SU

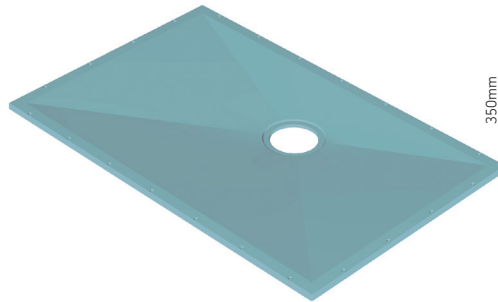

Former only code: 21028

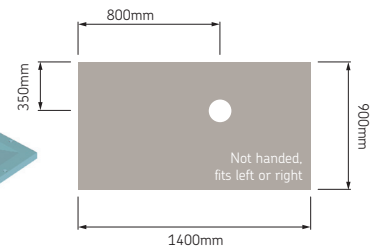

Tuff Form[®] – 1500 x 820

Compatible Level Best[®]
glass shower screens:

GA GB

Compatible Silverdale[®]
shower screens:

EW HFW NW

Compatible Wet Floor
shower screens:

BW EW HW HFW NW PW

TTW ZW XW

Compatible Sliding shower screens:

SE SJ SM SN SU SX SY

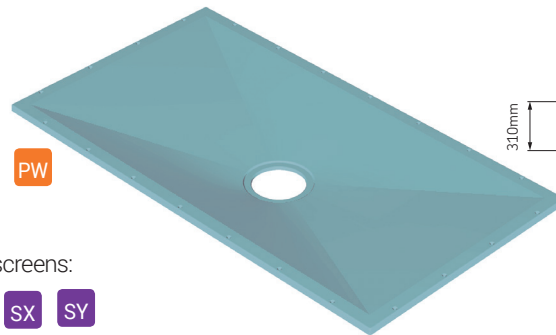

Former only code: 21036

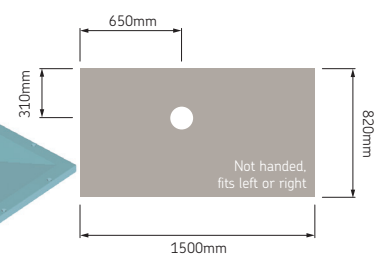

Tuff Form[®] – 1500 x 1200

Compatible Level Best[®]
glass shower screens:

GA GB

Compatible Silverdale[®]
shower screens:

HFW NW

Compatible Wet Floor
shower screens:

HW HFW PW NW TTW ZW

Compatible Sliding
shower screens:

SJ SM SN SU

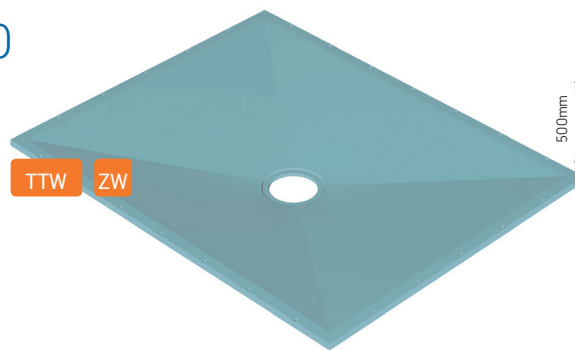

Former only code: 21045

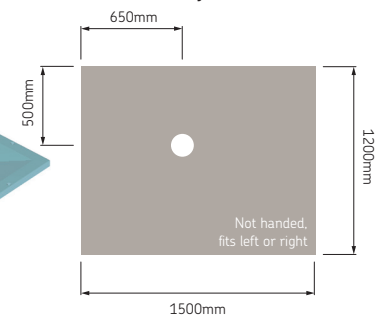

Tuff Form[®] – 1800 x 820

Compatible Level Best[®]
glass shower screens:

GA GB

Compatible Silverdale[®]
shower screens:

HFW

Compatible Wet Floor
shower screens:

HW HFW PW TTW ZW

Compatible Sliding
shower screens:

SJ SM SU SX

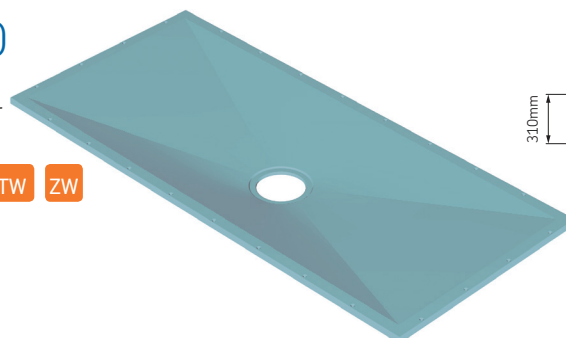

Former only code: 21050

