

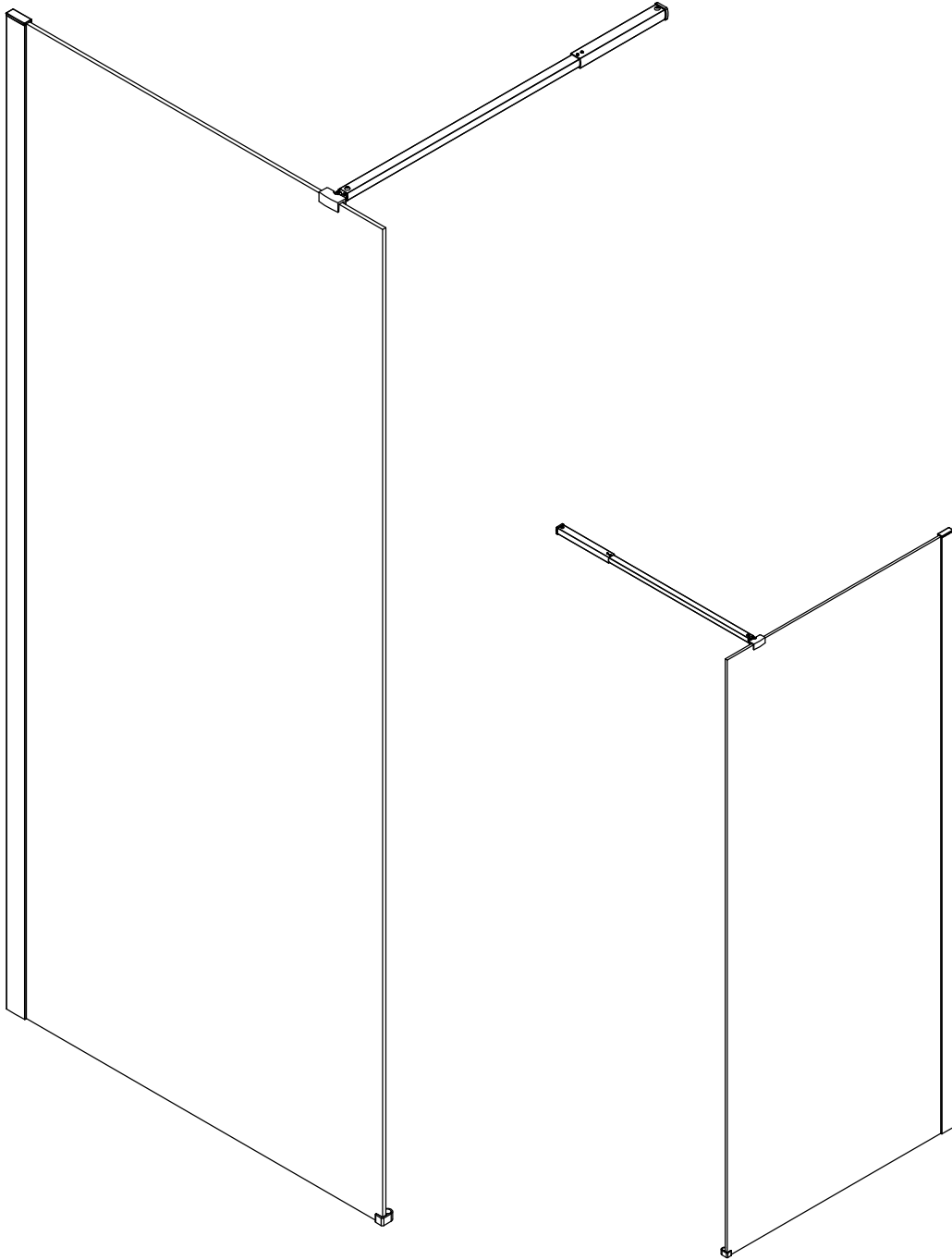

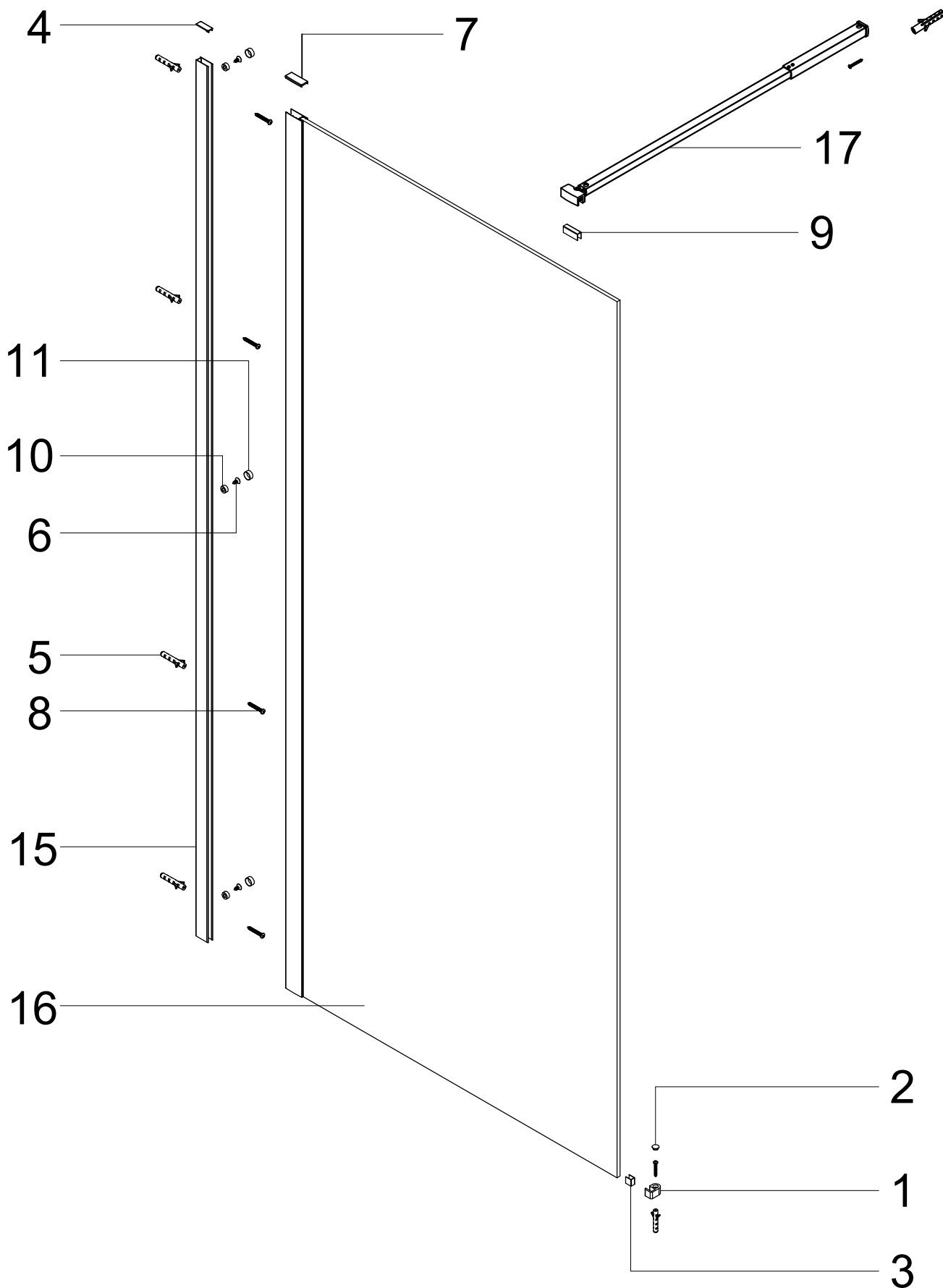

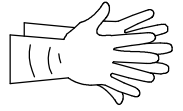

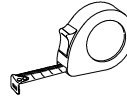

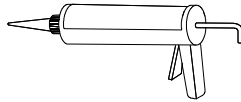
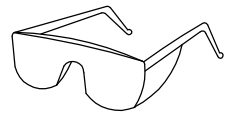
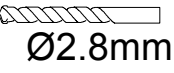
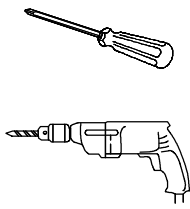
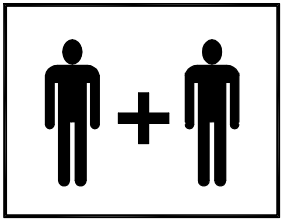

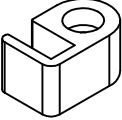
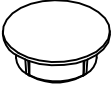

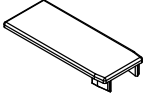
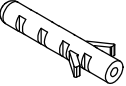
WETROOM-ARLEY Series

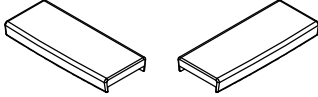
ASSEMBLY GUIDE





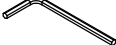

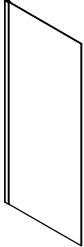
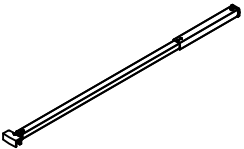
<p>1</p>  <p>X1</p>	<p>2</p>  <p>X1</p>	<p>3</p>  <p>X1</p>	<p>4</p>  <p>X1</p>
<p>5</p>  <p>X6</p>	<p>6</p>  <p>ST3.5X10</p> <p>X3</p>	<p>7</p>  <p>X1</p>	<p>8</p>  <p>ST3.9X35</p> <p>X6</p>
<p>9</p>  <p>X1</p>	<p>10</p>  <p>X3</p>	<p>11</p>  <p>X3</p>	<p>12</p>  <p>4 mm</p> <p>X1</p>
<p>13</p>  <p>3 mm</p> <p>X1</p>	<p>14</p>  <p>2 mm</p> <p>X1</p>	<p>15</p>  <p>X1</p>	<p>16</p>  <p>X1</p>
<p>17</p>  <p>X1</p>			

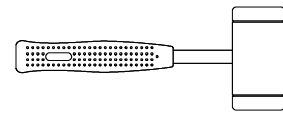
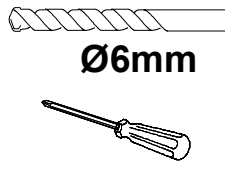
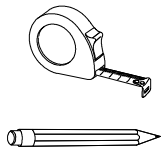
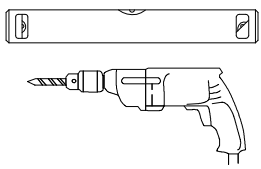

5 X4	8 ST3.9X35 X4	15 X1
-------------	----------------------	--------------

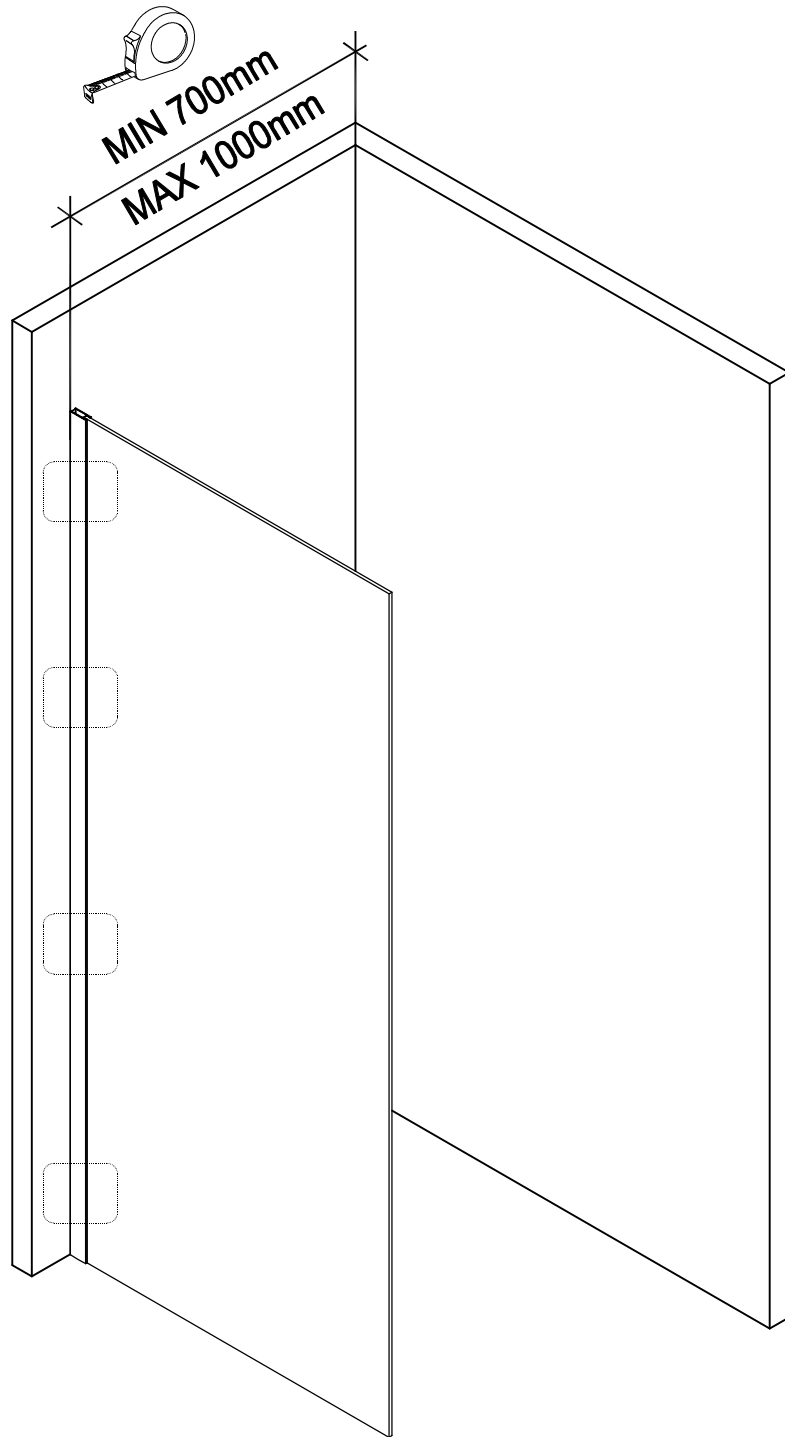
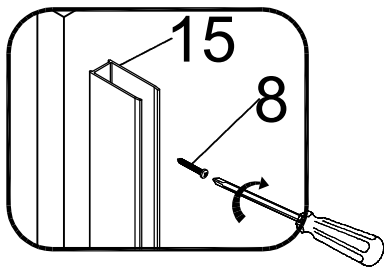
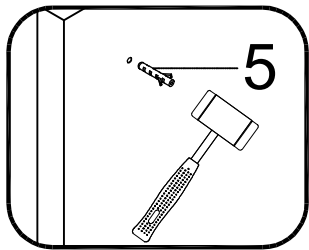
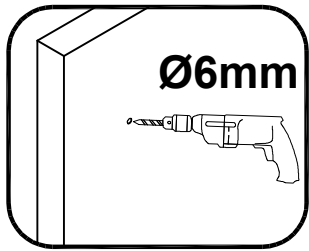
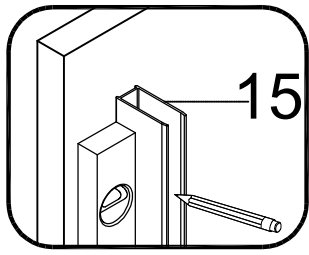

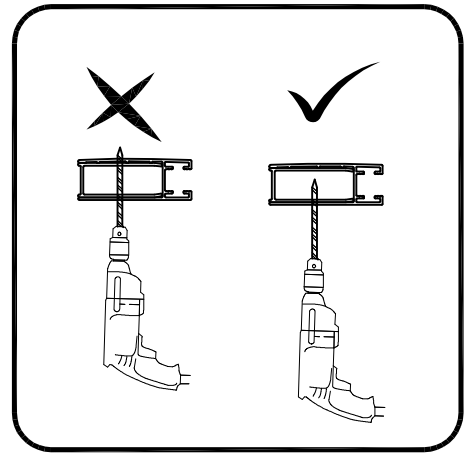
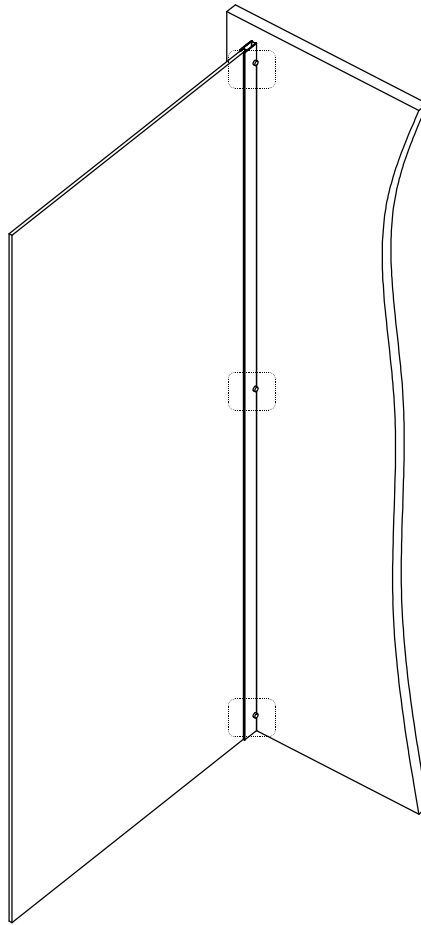
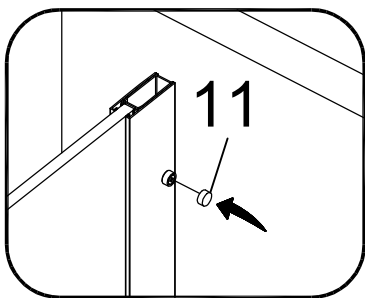
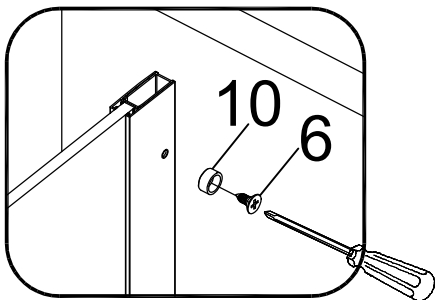
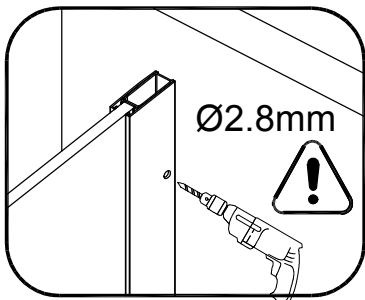
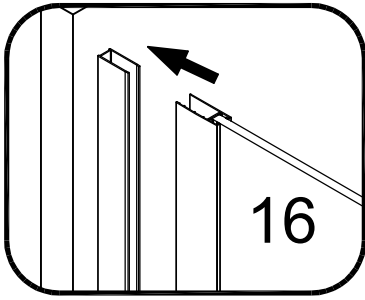
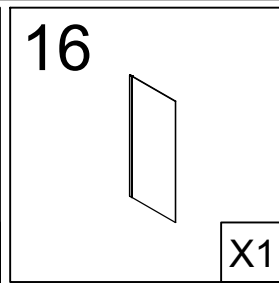
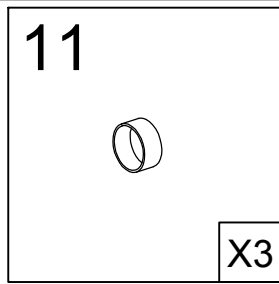
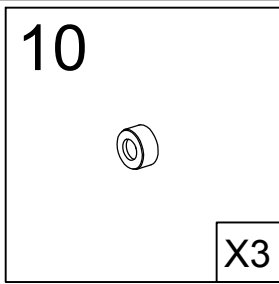
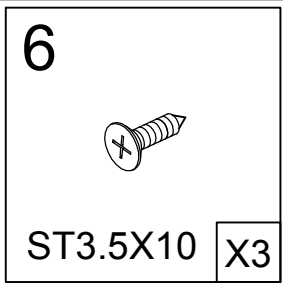
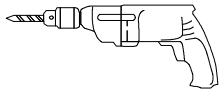

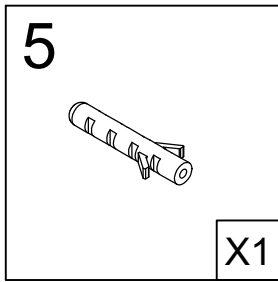
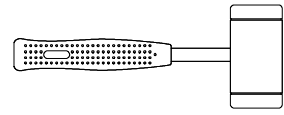
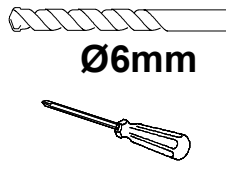
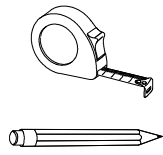
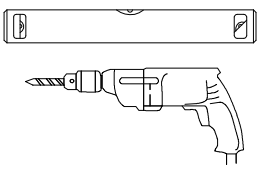

X1

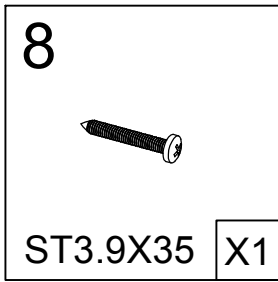

ST3.9X35

X1

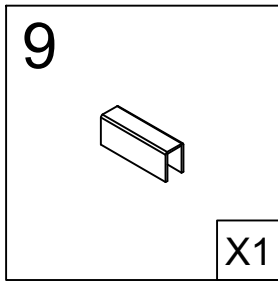

X1

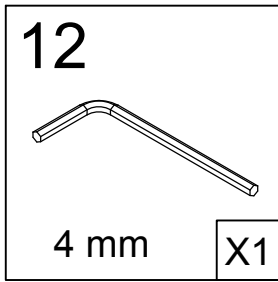

4 mm

X1

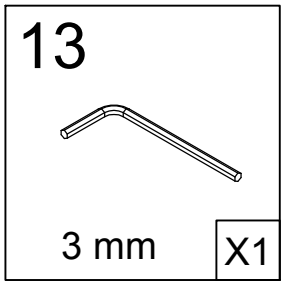

3 mm

X1

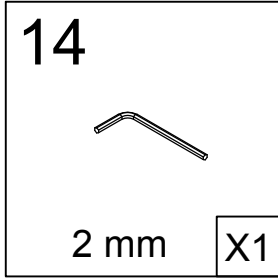

2 mm

X1

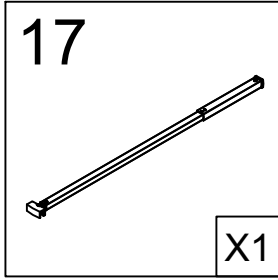

X1

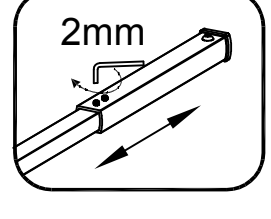
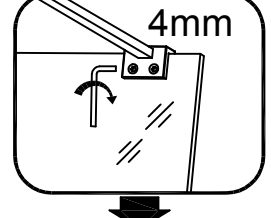
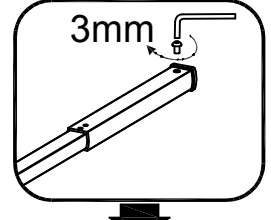
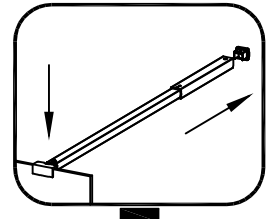
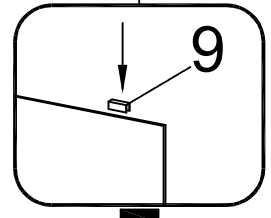
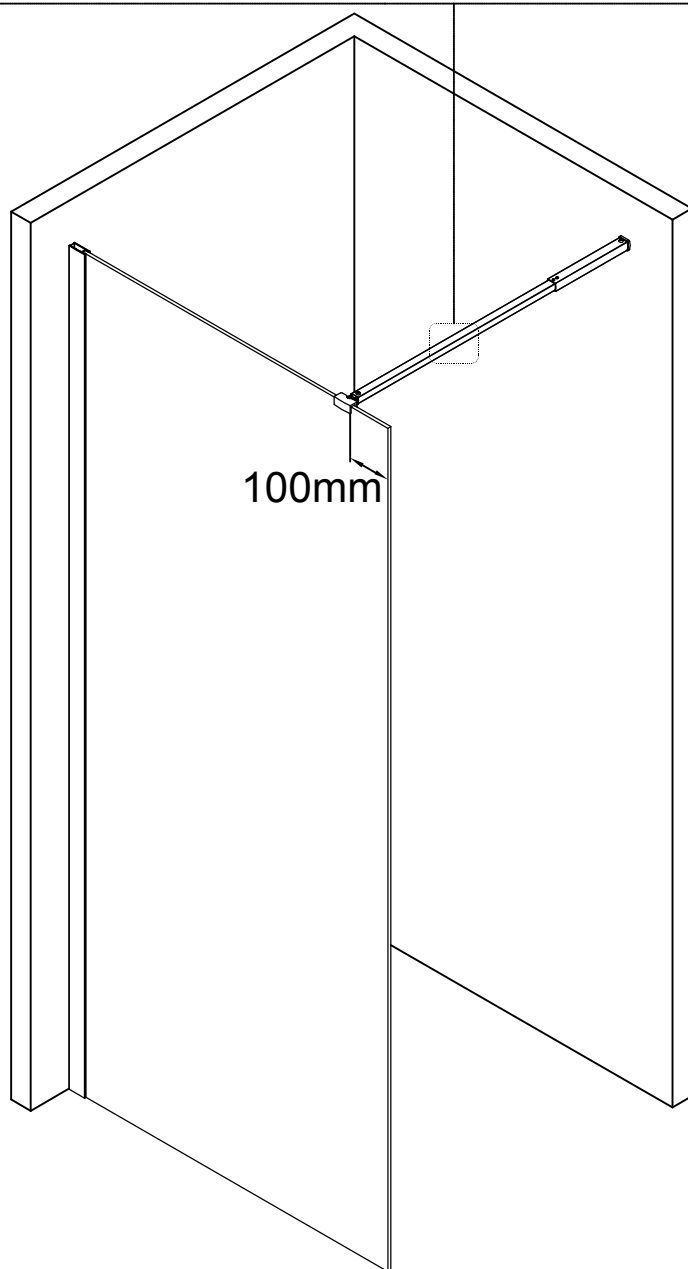
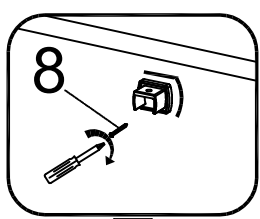
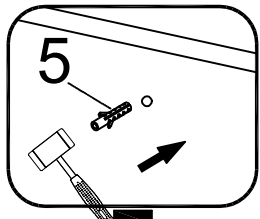
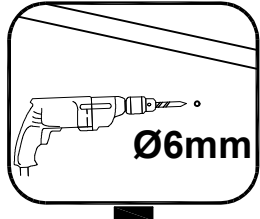
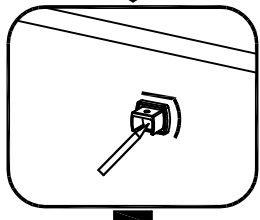
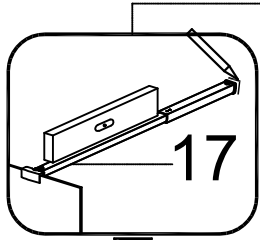

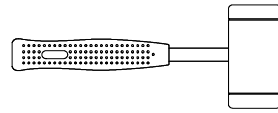
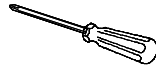
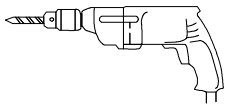

Ø6mm

1

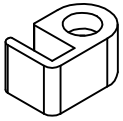

X1

2

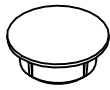

X1

3



X1

5

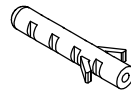

X1

8



ST3.9X35

X1

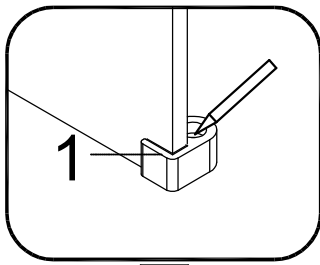

1

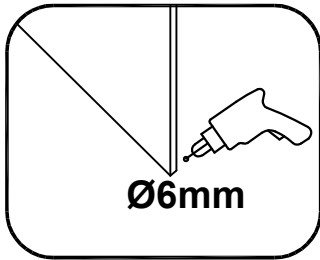

Ø6mm

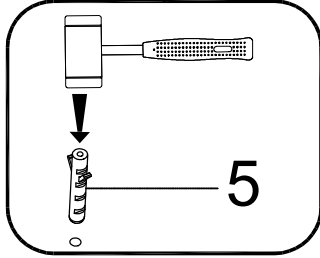

5

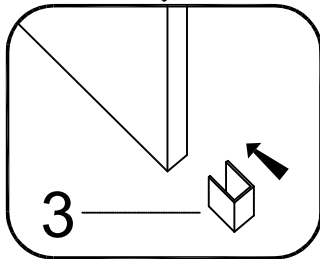

3

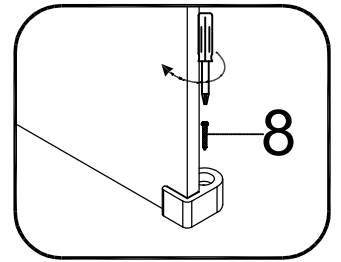
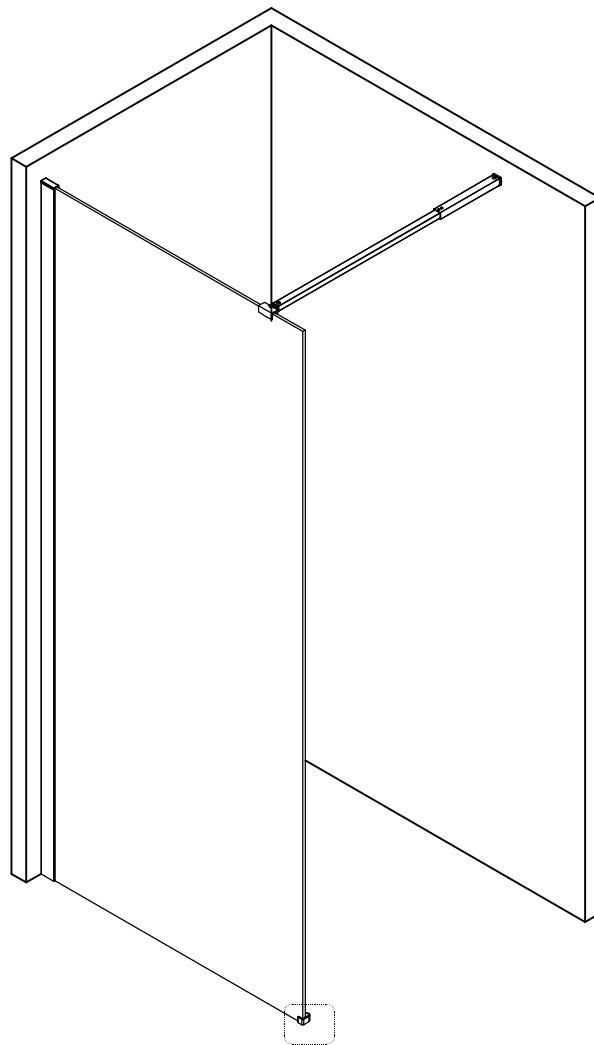

8

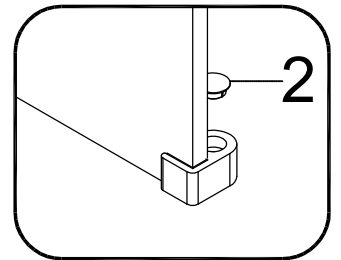

2

