

B A Y S W A T E R

London W.2

CODE: BAYT109

DESCRIPTION: 3Th Wall Bath Filler/Xhead/Hex Collar

CATEGORY: Taps

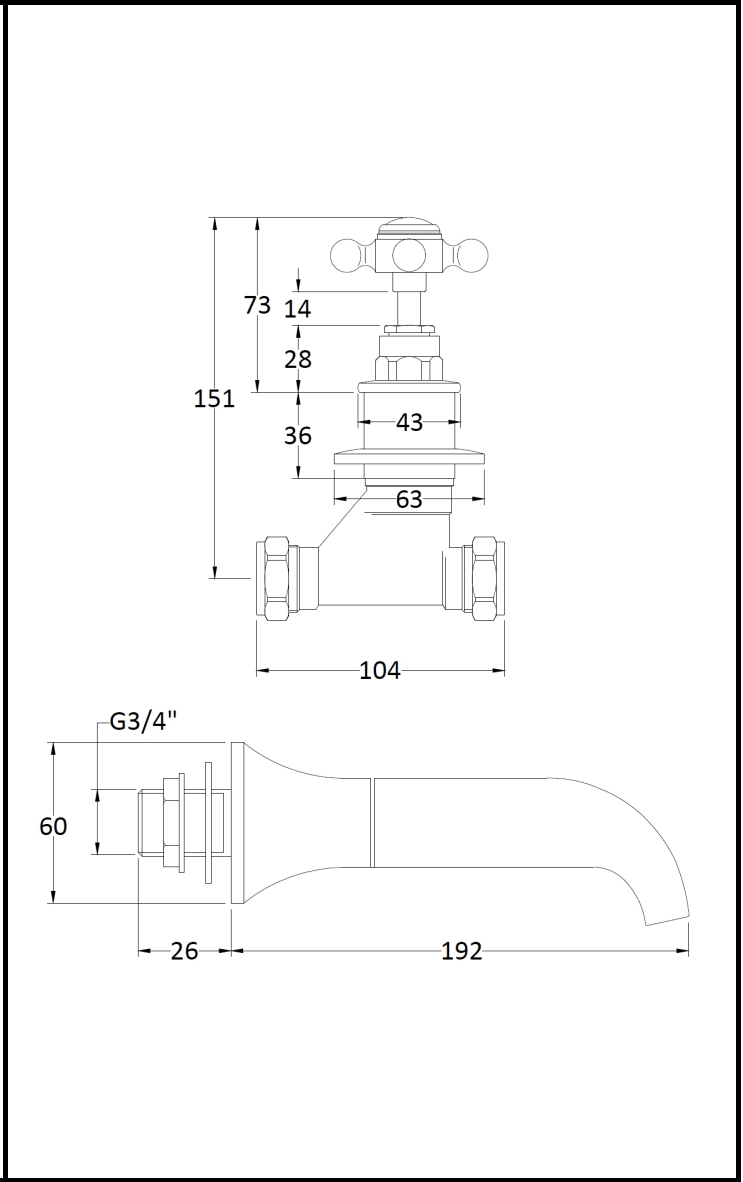

PRODUCT DIMENSIONS				
Height (mm)	Width (mm)	Depth (mm)	Length (mm)	Nett Wgt Kg
181	66	182		2.5

PACKAGING DIMENSIONS			
Height (mm)	Width (mm)	Depth (mm)	Gross Wgt Kg
270	185	85	2.5

PACKAGING DATA			
Box Colour	White Cardboard Box		
Box Qty	1	Label Colour	White Label
Label Size	100 x 50	Label Qty	2

OUTER BOX DIMENSIONS (If Applicable)				
Height (mm)	Width (mm)	Depth (mm)	Length (mm)	Gross Wgt Kg
400	280	560		15
Barcode	5055275889060			

PRODUCT DETAILS	
Country of Origin	United Kingdom
Fitting Instruction	Yes
Product Material	Brass
Control Type	Manual
Waste Included	Waste Not Included
WRAS Approval	No Approval No. N/A
Operating Pressure (bar)	0.1
Valve/Cartridge Type	1/4 Turn Ceramic Disc

Colour/Finish	Chrome
Mount Type	Deck
Waste Type	Not Applicable
Flow Rates (L/min)	0.1 9.6 0.5 1 28 2 39.5 3 46.8
Pipe Size	22 mm (3/4" Bsp)
Pipe Centres	N/A