

B A Y S W A T E R

London W.2

CODE: BAYT312

DESCRIPTION: Wall Mount 3Th Basin Tap Dome Lever

CATEGORY: Taps

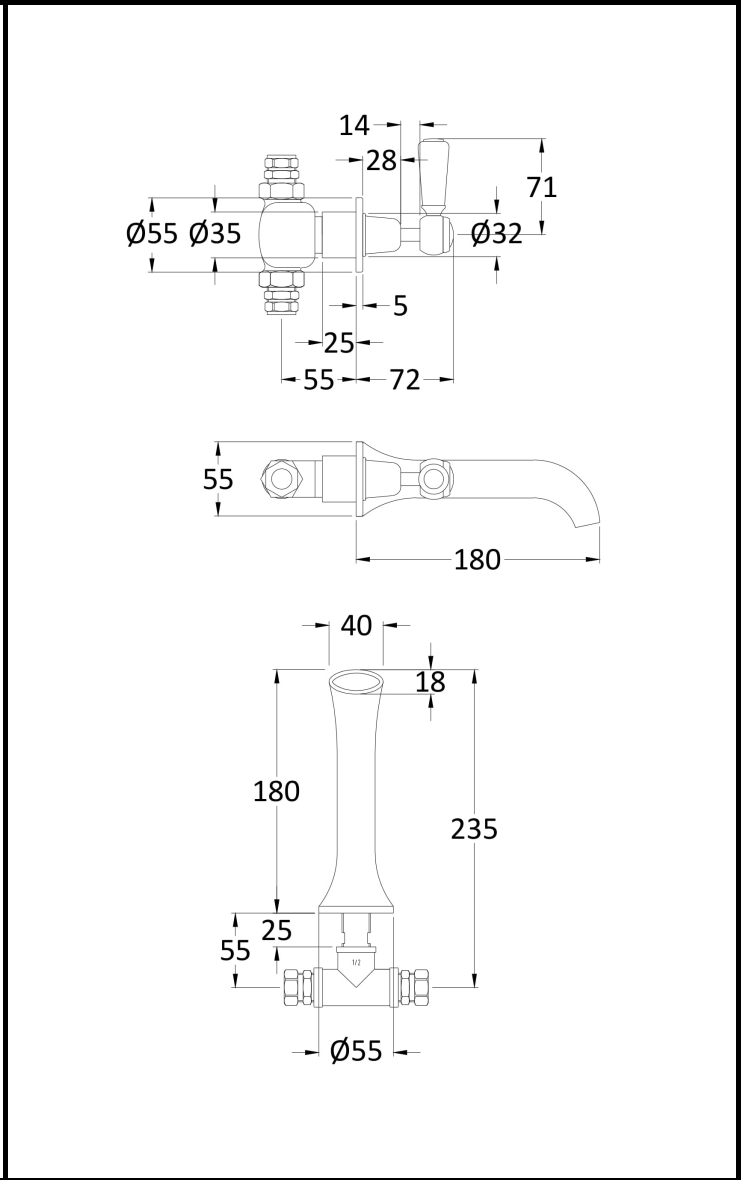

PRODUCT DIMENSIONS				
Height (mm)	Width (mm)	Depth (mm)	Length (mm)	Nett Wgt Kg
55		180		2

PACKAGING DIMENSIONS			
Height (mm)	Width (mm)	Depth (mm)	Gross Wgt Kg
65	350	213	2

PACKAGING DATA			
Box Colour	White Cardboard Box		
Box Qty	1	Label Colour	White Label
Label Size	100 x 50	Label Qty	1

OUTER BOX DIMENSIONS (If Applicable)				
Height (mm)	Width (mm)	Depth (mm)	Length (mm)	Gross Wgt Kg
Barcode	5056211865391			

PRODUCT DETAILS	
Country of Origin	China
Fitting Instruction	No
Product Material	Brass
Control Type	Manual
Waste Included	Waste Not Included
WRAS Approval	No Approval No. N/A
Operating Pressure (bar)	0.1
Valve/Cartridge Type	1/4 Turn Ceramic Disc

Colour/Finish	Chrome
Mount Type	Wall
Waste Type	Not Applicable
Flow Rates (L/min)	0.1 8 0.5 1 27.5 2 39.4 3 47.8
Pipe Size	15 mm (1/2" Bsp)
Pipe Centres	N/A