

B A Y S W A T E R

London W.2

CODE: BAYS303

DESCRIPTION: 12 Apron Fixed Head (300mm)

CATEGORY: Showers

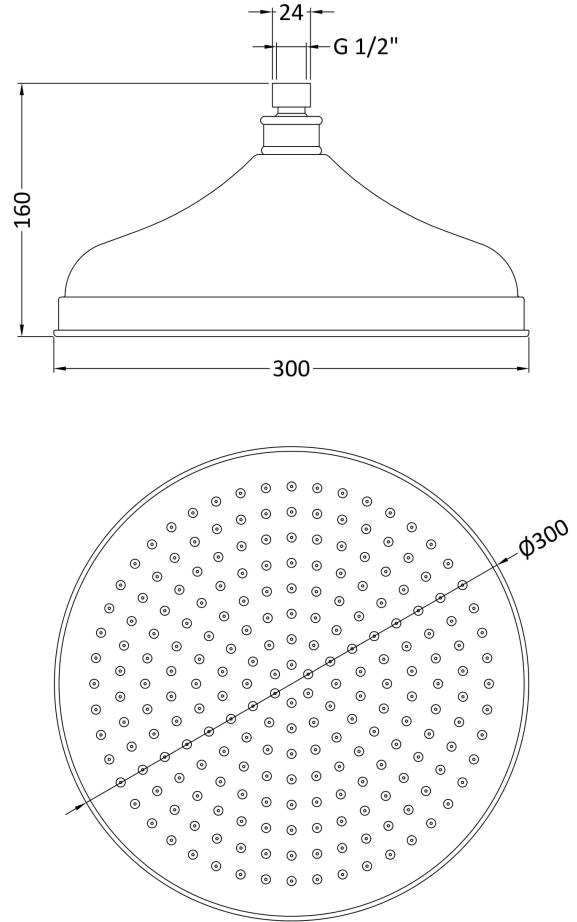

PRODUCT DIMENSIONS				
Length(mm)	Width (mm)	Height (mm)	Depth (mm)	Nett Wgt Kg
	300	145	300	1.8

PACKAGING DIMENSIONS			
Depth (mm)	Width (mm)	Height (mm)	Gross Wgt Kg
320	130	320	2.1

PACKAGING DATA			
Box Colour	White Cardboard Box		
Box Qty	1	Label Colour	White Label
Label Size	100 x 50	Label Qty	2

OUTER BOX DIMENSIONS (If Applicable)				
Length (mm)	Width (mm)	Height (mm)	Depth (mm)	Gross Wgt Kg
	660	330	330	10
Barcode	5055275890707			

PRODUCT DETAILS	
Country of Origin	United Kingdom
Fitting Instruction	No
Product Material	Brass
Mount Type	Wall, Surface
Outlet Elbow Supplied	No
Easy Clean	No
Head Included	Yes
Handset Included	No
Body Jets Included	Not Applicable
No of Body Jets	Not Applicable
Operating Pressure (bar)	0.5
Valve/Cartridge Type	Not Applicable

Flow Rates (L/min)	0.1 bar	N/A	0.5 bar	N/A	1 bar	N/A	2 bar	N/A	3 bar	N/A
TMV2 Approved	No		Approval No.		N/A					
TMV3 Approved	No		Approval No.		N/A					
WRAS Approved	No		Approval No.		N/A					
Head Function	Single									
Handset Function	Not Applicable									
Body Jet Info	Not Applicable									
Pipe Size	Not Applicable									
Pipe Centres	N/A									
Colour/Finish	Chrome									
Hose Included	Not Applicable									