

QST 1/2 C

QUEST Tap Range Quest Basin Taps Chrome



Features:

- Long life and easy to use 1/4 turn ceramic disc valves
- Metal back nuts for added durability
- Easy to use metal handles
- Chrome plated to BS EN 248

Product Certifications:



WRAS Certificate No: 2203908
WRAS Expiry Date: 31/03/2027



For more products, visit our website:
<http://www.bristan.com>



Specification

Product Type:	Bathroom Taps
Main Construction Material:	Brass
Mount Type:	Deck
Handle Type:	Lever
Connection Inlet:	1/2" BSP
Connection Outlet:	M16 Aerator
Number of Tap Holes:	2
Valve/Cartridge Type:	1/2" Ceramic Disc Valve
Plumbing System Requirements:	Suitable for all plumbing systems
Minimum Dynamic Pressure (bar):	0.2 bar
Maximum Dynamic Pressure (bar):	5.0 bar
Maximum Hot Water Temperature °C:	65°C
Maximum Static Pressure (bar):	10 bar
Isolation Included:	No

Dimensions (measurements in mm)

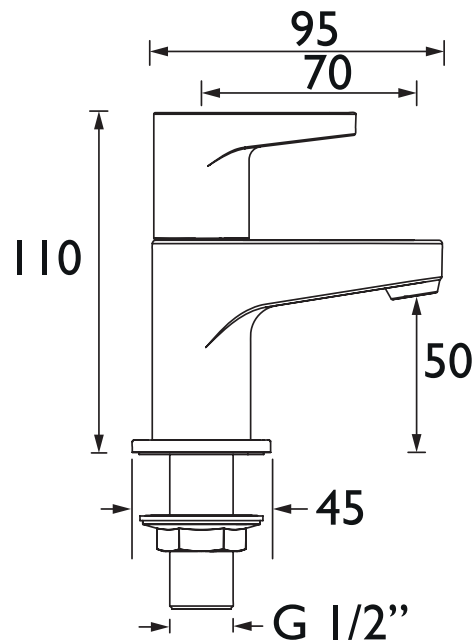

Flow Rates (l/min)

System Pressure (bar)	0.2	0.5	1	2	3	5
QST 1/2 C (Cold)	8.4	13.2	18.7	26.5	32.4	41.8
QST 1/2 C (Hot)	8.4	13.2	18.7	26.5	32.4	41.8

TECHNICAL DATA SHEET



BRISTAN

D9