

Guarantee and Registration

Guarantee

All products are manufactured to the highest standards and 5-year guarantee covers any defect in manufacture.

Any part found to be defective during the above guarantee period will be replaced without charge providing that the product has been installed in accordance with our instructions, used as intended and maintained/serviced as recommended.

In the unlikely event that any problems are encountered with this product's performance on installation, you must obtain guidance/authorisation from our Customer Service Department before any remedial action is taken and be able to supply proof and date of purchase.

The guarantee excludes damage caused by accident, misuse or neglect and does not cover the following:

- Those components subject to wear and tear such as 'O' rings and washers etc,
- Damage caused by faulty installation,
- Damage caused by any waterborne debris,
- Damage caused by improper cleaning products,
- Damage caused by the use of non-Bristan parts,
- The product being used for a purpose other than intended.

The company reserves the right, in the event of a claim not covered by the guarantee, to charge the claimant for parts and labour at current rates. This guarantee is given in addition to and does not affect your statutory rights.

In the interests of continuous product development we reserve the right to alter the specification as necessary.

Registration

To register your product with us please complete and return the enclosed registration card.

**PRODUCT CODE: FU MTLSHX C
JU MTLSHX C**

TELEPHONE HELP LINE! 0844 701 6273

Bristan Group Limited
Birch Coppice Business Park
Dordon,
Tamworth
Staffordshire
B78 1SG
UK

A Masco Company
Web: www.bristan.com
Tel: 0844 701 6274
Facsimile: 0844 701 6275
Email: enquire@bristan.com

(FI JU / FU INLINE)

(REV.D3)

(AJ)

BRISTAN

Mini Twinline Sequential Shower Valves

Installation, Operation And Maintenance Guide

JU MTLSHX C

Jute Single Control
Mini Twin-line Shower
Valve With Adjustable Riser

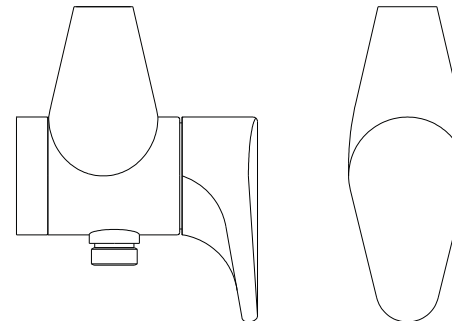

FU MTLSHX C

Fuse Single Control
Mini Twin-line Shower
Valve With Adjustable Riser

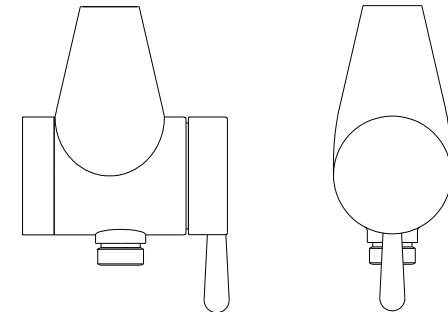

Before starting any installation project please consider:

Prior to drilling into walls, check there are no hidden electrical wires, cables or water supply pipes with the aid of an electronic detector. If you use power tools do not forget:

- Wear eye protection
- Unplug equipment after use

Please keep these instructions for future reference and the request of replacement parts

This Shower Valve has been designed with crisp clean modern styling. With its revolutionary Hot and Cold water supplies contained within the 25 mm riser tube, it can be fitted with the minimum of disruption to existing decor. All supply piping can be hidden above the ceiling of the room where the valve is fitted or between floor joists.

Technical features are listed below:-

SUPPLY REQUIREMENTS

Minimum cold water supply temperature: **5°C**

Maximum cold water supply temperature: **20°C**

Maximum hot water supply temperature: **85°C**

(a temperature of 60-65°C is recommended for ablutionary installations)

Note! A suitable hot water temperature control device should be installed to reduce temperatures exceeding the above maximum hot water supply temperature.

Minimum temperature differential between hot supply and outlet temperature: **10°C**

(eg. shower temperature 43°C: minimum hot supply 53°C)

Factory pre-set temperature: **43°C**

Minimum dynamic pressure: 0.1 bar

Maximum dynamic pressure: 5.0 bar

Maximum static pressure: 10 bar

SITE REQUIREMENTS

To ensure the correct operation of your Mini In-Line valve it is important to fully understand your site installation. This thermostatic barrel valve will suit the following -

HIGH PRESSURE	LOW PRESSURE	MAINS PRESSURE
PUMPED PRESSURE	UNEQUAL PRESSURE	GRAVITY PRESSURE

IMPORTANT INFORMATION

The shower valve is factory fitted with filter/washers (item 16, shown on page 6) in the hot and cold supply inlets. they are required to protect the valve from damage. Failure to run the product with these in place will invalidate the guarantee.

The shower valve has the flow limiters (items 13+18, shown on page 6) factory fitted if the product is to be used on a low pressure system they must be removed to ensure correct operation of the unit.

WATER REGULATIONS





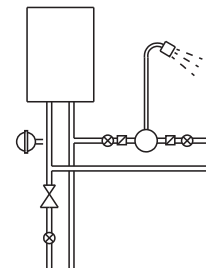

Shower installation in all respects must meet with the recommendations of Water Regulations guide. If in doubt you should contact your local Water Authority for advice or The Institute of Plumbers on:

Tel: 0170 847 2791

Instantaneous heated system (Gas or Electric)



Key

-  Shower inc. non-return valves
-  Isolating valve
-  Tempering valve
-  Pressure regulating valve
-  Strainer
-  Expansion vessel (optional)
-  Twin Impeller Pump

Gravity fed system

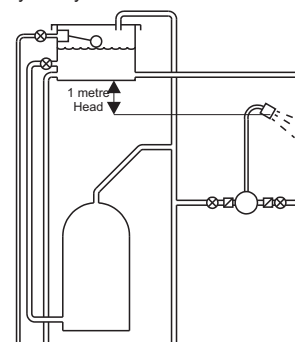

Pumped system

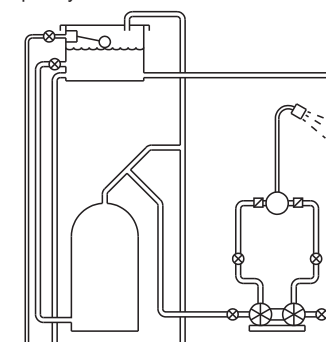

Unvented mains pressure system

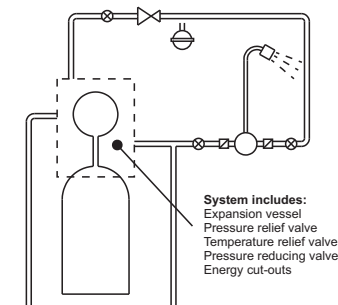

Mains pressurised hot water system

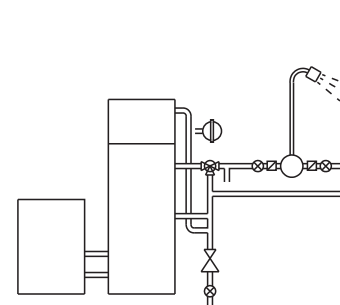

The above systems are typical types that this product will accommodate. If however your cold water supply to the valve is mains pressure then the following will apply:-

- a) Hot supply between 1 to 4 metres (0.1-0.4 bar). Mains cold supply up to 10 bar.
Fit 10 litre (yellow) limiter into cold inlet only.
- B) Hot and Cold supply above 5 metre (0.5 bar).
Fit 10 litre (yellow) limiter into cold inlet & 6 litre (grey) limiter into hot inlet elbow.

Installation

(Refer to illustrations on Pages 6,7 &11)

1) Before starting installation of the shower valve careful consideration must be taken to ensure when the Ø25 riser pipe is fed through the ceiling that this will not interfere with existing pipework, joists or electrical equipment and adequate space exists in the roof or between floors.



Before starting any installation project, consider "Safety" first. Look for the "safety note" sign and read the safety advice.

2) Once the position for location has been decided the wall plate (5) must be fixed to the wall using screws and wall plugs provided (7+8).

3) Take a measurement of 965 mm from the centre of the wall plate (5) to a position vertically above the wall plate. Mark this position with a pencil and then drill and fit wall plugs (if required). (See page 11)

4) Fit riser wall support to wall using screw provided (page 6), after this has been done fit grey plastic insert into wall support with the slot in it facing the wall. Refit brass riser clamping screw. Keep the chromed indice in a safe place for final fitting once the rest of installation is complete.

5) Cut the hole through the ceiling so that the Ø25 mm riser pipe can pass through. To establish the required position of the hole in the ceiling feed one of the pieces of Ø25 riser through the riser wall support until it touches ceiling and scribe around it using a pencil (ensuring tube is parallel to the finished wall).

6) Remove riser tube and prepare for cutting.

7) Drill a small pilot hole through the ceiling (suggested diameter approx. Ø10mm)

8) Go into attic/room above installation to establish that the position still does not interfere with existing pipework, electric cables, joists etc.

9) If position chosen is suitable proceed to cut a Ø30mm (1 3/16") hole through ceiling.

10) Screw the two halves of the Ø15mm brass tube together ensuring you do not cross thread the pipe and making sure the o-ring is in place and it is not trapped when screwing together.

11) Screw the two halves of the Ø25mm chromed riser tube together ensuring you do not cross thread the tube and making sure the o-ring is in place and it is not trapped when screwing together.



12) The Ø15mm brass tube is now placed inside the Ø25 chrome tube .

13) Offer the riser tube through the wall support. Feed tube through ceiling after first sliding chrome ceiling rose over Ø25mm chrome pipe.
(If the tubes are too long please refer to section Cutting Tubes To Length on page 7)

14) Place wall plate (5) over the shower valve (4) using the M5 grub screw (6) and tighten in place using 2.5mm hexagonal key provided.

15) Slide the hose retainer, chrome cover, compression nut, and Ø25mm copper olive onto the Ø25 mm chrome tube IN THIS ORDER.

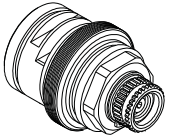
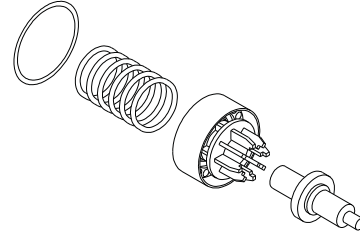
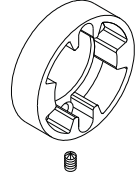
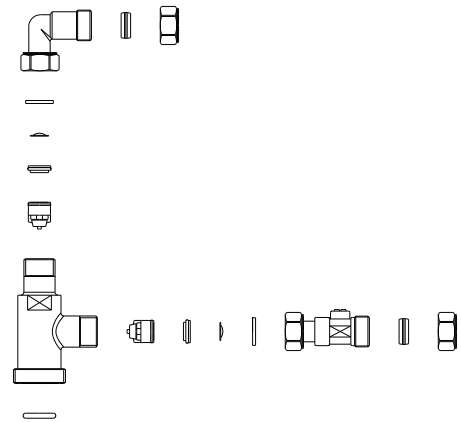
Spares For FU MTLSHX C

SEALS KIT			
SKINLINE-1	QTY 1	SK971006	QTY 1
			
SK1500-3	QTY 1	SK420301CP	QTY 1
			
		SKFU-4CP	QTY 1
		Kit Spares	
		Hose	- HOSE104 C
		Handset	- HAND101 C
		Riser Assembly	- SK420302CP
SKINLET-14	QTY 1		

Spares For JU MTLSHX C

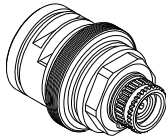
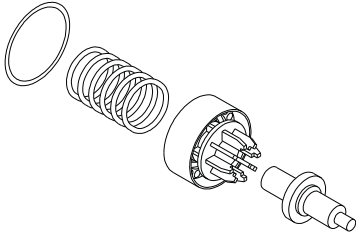
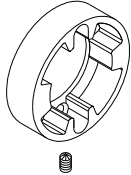
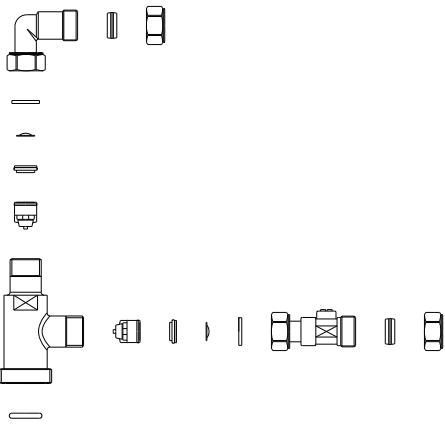
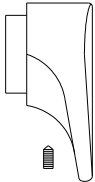
SEALS KIT			
SKINLINE-1	QTY 1	SK971006	QTY 1
			
SK1500-3	QTY 1	SK420301CP	QTY 1
			
		SKJU-4CP	QTY 1
		Kit Spares	
		Hose - HOSE104 C	
		Handset - SK760681CP	
		Riser Assembly - SK420302CP	
SKINLET-14	QTY 1		

Installation (continued)

16) Slide the Ø15mm brass tube into shower valve body (4) you must push it past the O-ring (9) inside the body to make a watertight seal.

17) Screw the Ø25mm chrome riser tube into the shower valve body.

18) To fit the supply manifold assembly (12) onto the tubes above the room where the valve is fitted, you must first place the nut and olive over the Ø25mm chrome riser pipe.

19) Push the manifold assembly over the Ø15mm tube and carefully push down onto the Ø25mm tube taking care to not damage the o-ring (11) inside the manifold body as this must provide a watertight seal. Secure the Ø25mm tube using the Compression nut. (Use 38mm a/f spanner). Ensure a watertight seal.

Note:- The hot water will be fed to the valve via the Ø15mm tube and the Isolation elbow (14). The cold water is fed to the valve via the Ø25mm tube and isolation straight (17) forming a cooling 'jacket' around the hot supply.

20) Hot and cold water supplies are to be fed to the manifold assembly and fitted to the isolation elbow (14) and isolation straight (17) using the Ø15mm compression fittings on the end of each of these units.

21) It is advisable to flush the system before you start using the shower valve this can easily be done by isolating the water feed at the isolation elbow (14) and isolation straight (17) disconnect them from the manifold assembly (12) and by opening up the isolation valves and allow water to be run into a suitable container until all debris is removed from water supplies.

22) Re-connect isolating units to inlet manifold not forgetting to refit washer/filters (16) and in the case of low pressure systems (0.5 bar and below) remove yellow and grey flow limiters (13+18) from the inlet bores of the manifold (12).

NOTE:-Failure to refit items 16 will invalidate the guarantee.

23) Turn on water supplies and check for leaks . Correct if required.

24) The chrome ceiling rose needs pushing up to the ceiling and the indice needs fitting to the riser wall support bracket after you have tightened down the brass tube retaining screw (see page 6).

25) Screw the flexi hose onto the handset then screw the flexi hose to the bottom outlet of the shower valve. Please note there should be a rubber sealing washer between each of these connections to prevent water leaks. The hose end with the hexagon swivel nut is the end to connect to the shower valve.

26) The shower valve is factory set with a maximum temperature of **43°C**, depending on the system it is connected to it may require re-calibrating to achieve the correct maximum working temperature. Please refer to Maximum Temperature Setting on page 8.

Exploded view drawing & parts list

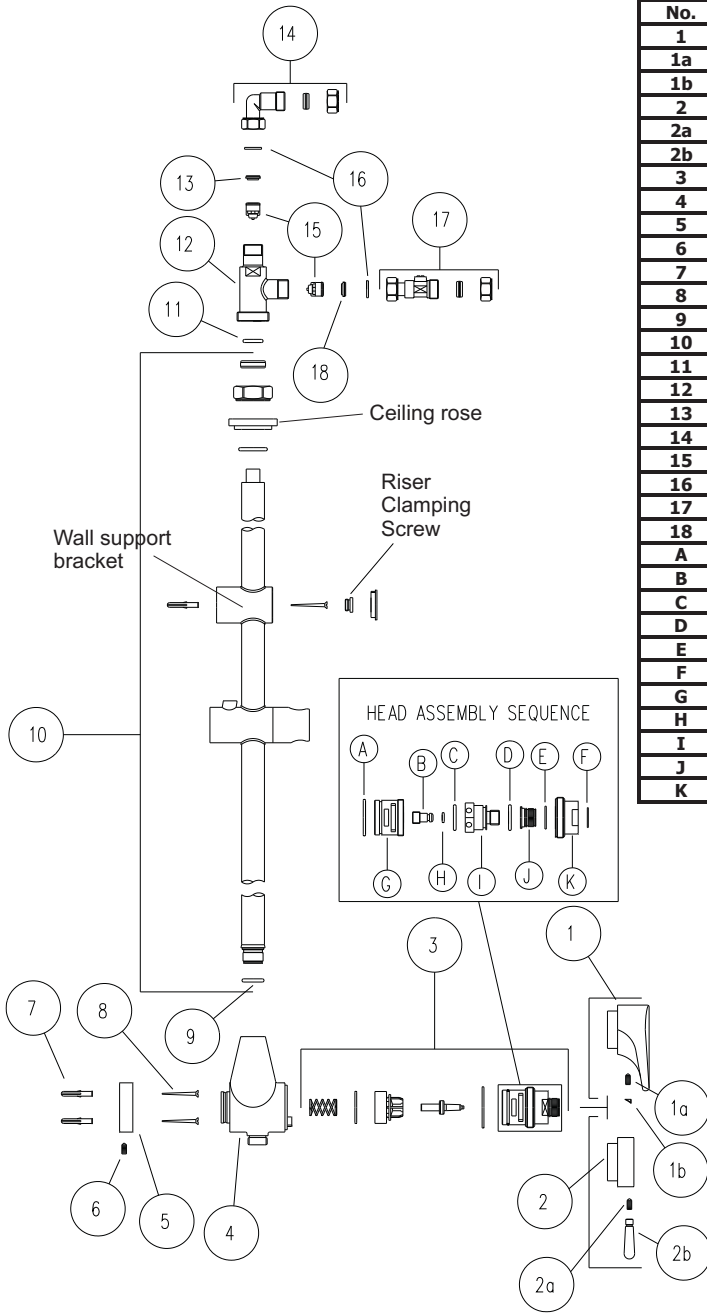

6

No.	Description
1	JUTE Control Knob
1a	M5 x 8mm grub screw
1b	Chrome Button
2	Fuse Control Knob
2a	M5 x 8mm grub screw
2b	FUSE Handle Spoke
3	Head Assembly (Spare)
4	Single In-line Valve Body
5	Single In-line Backplate
6	M5 x 8mm grub screw
7	Wall plug
8	No.8 x 1.5" C'sunk Woodscrew
9	O - RING
10	Single In-line Kit
11	O - RING
12	Manifold Assembly
13	6 Ltr/m Flow Limiter
14	Isolation Elbow
15	Check Valve
16	Filter
17	Isolation Straight
18	10 Ltr/m Flow Limiter
A	O - RING
B	Adjusting Screw
C	O - RING
D	O - RING
E	PTFE Washer
F	Stainless Steel Circlip
G	Half Cartridge
H	O - RING
I	Non Shut Off Head
J	Flownut
K	Head

Dimensional Drawing

All dimensions in mm.

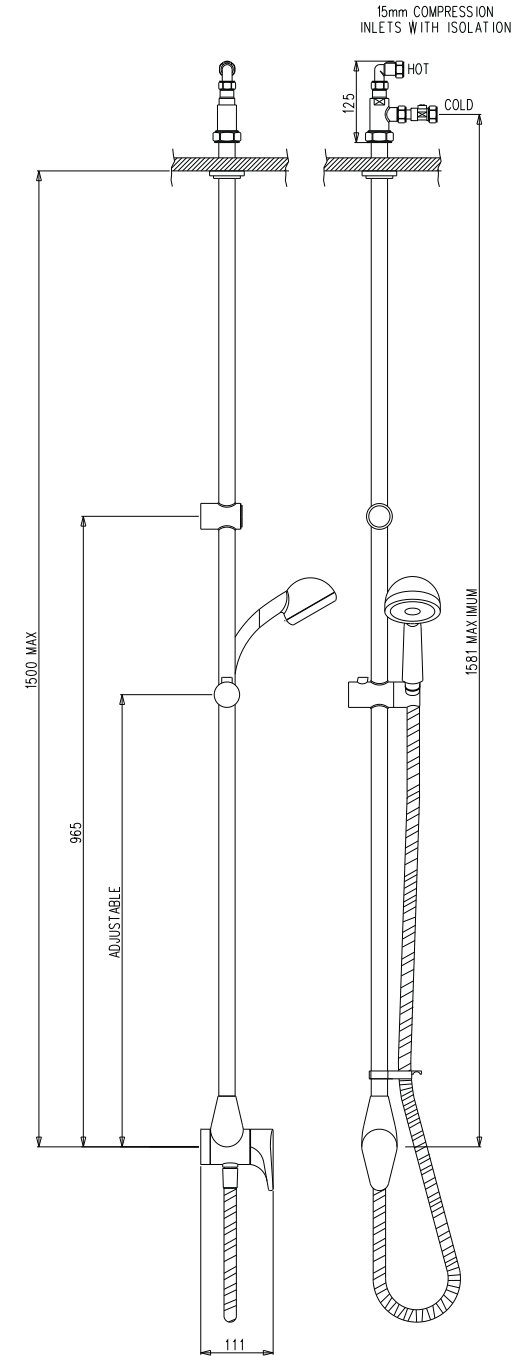

11

Cleaning Lubrication and re-assembly

- 1) Soak all metal parts in descalent, wash off in clean water.
- 2) Examine all o-rings and replace if necessary.
- 3) Use silicon based grease on all seals (light smear only). A maintenance kit is available, which contains all seals and grease from your local stockist or manufacturer.

RE-ASSEMBLY

(You may find it easier to take the unit off the wall and hold it horizontally to re-assemble)

- 1) Replace the spring in the bottom of the valve followed by the piston assembly and thermostat.
- 2) Screw the head assembly (3) into the barrel valve, taking care not to cross thread, and fully tighten.

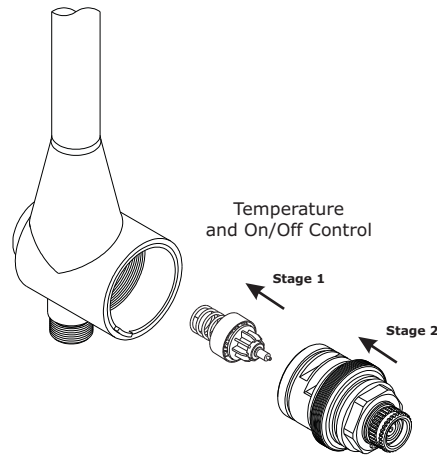

GENERAL FAULT DIAGNOSIS

If your thermostatic mixing valve fails to operate either immediately upon installation or after a period of time, the following points should be checked;

- 1) Check the hot & cold water feeds have been correctly fitted to the inlet manifold.
- 2) Isolate supplies and ensure that both hot and cold supplies are reaching the valve body. You may need to dis-connect supply pipes to check this.
- 3) Ensure that there is no debris between the faces of the piston and it's mating faces, the bottom of the valve body and the cartridge.
- 4) Check that the valve has been installed correctly in accordance of its particular feed system (i.e use of flow limiters where necessary).
- 5) Check that the hot water temperature source is sufficient; preferred minimum of 60°C.

Tube Cutting

CUTTING TUBES TO LENGTH.

In the event of the Ø25mm chrome riser tubes and Ø15mm brass inner being too long it is possible to cut the tubes, but the following points need to be taken into consideration:

- 1) Before doing any cutting of the pipes you must realise that the length differential between the Ø15mm brass tube and the Ø25mm chrome tube must be maintained. The Ø15mm tube is longer than the Ø25mm chrome tube by **57mm this size must be maintained within a tolerance of + or - 2mm.** Therefore if 20mm is cut off outer tube 20mm must be cut off inner tube to maintain the differential.
- 2) The brass Ø15mm inner tube must end up with a rolled edge to stop it cutting into the o-ring seal which would cause the unit to leak. To achieve this use a pipe cutter that is available from most reputable plumbing outlets. **DO NOT HACKSAW.**
- 3) The Ø25mm chrome tube can be cut using the method above or alternatively by hack-sawing using a junior hacksaw. Care should be taken to ensure that you cut the pipe square and that after hack-sawing any burrs are removed from the inner and outer edges and do not leave any debris in the tube. Make sure that you can still get the copper olive over the pipe.

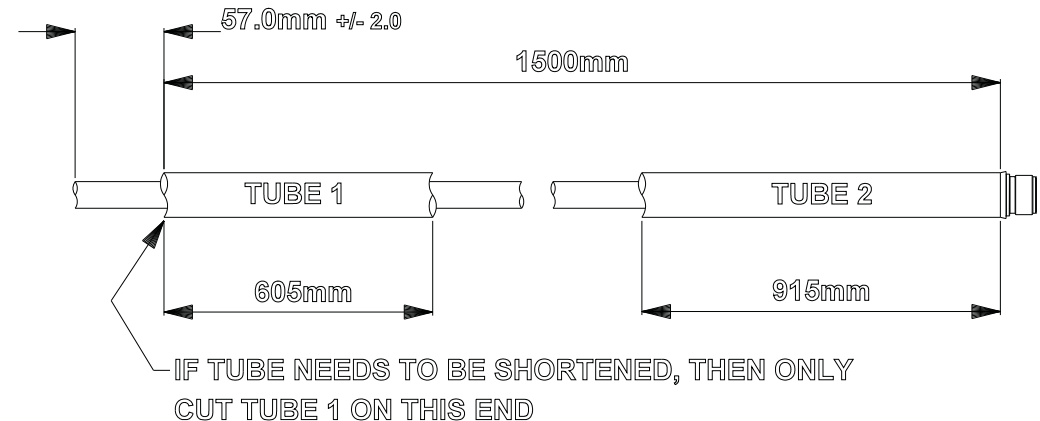

Maximum Temperature Setting

The shower valve is factory set to 43°C maximum but may require calibration on installation. If necessary adjust as follows :-

- 1) Turn the lever/knob anti-clockwise to the maximum temperature position.
- 2) Remove the lever/knob. See Service/Maintenance page 9.
- 3) Using a 2.5mm hexagonal key through the head of the cartridge, turn the adjusting screw to alter the temperature.
 - > Turn the adjusting screw clockwise for cooler temperature.
 - > Turn the adjusting screw anti-clockwise for warmer temperature.

The temperature should be set to a maximum of 43°C for user safety.

Please Note:- Hotter temperatures may cause serious injury.

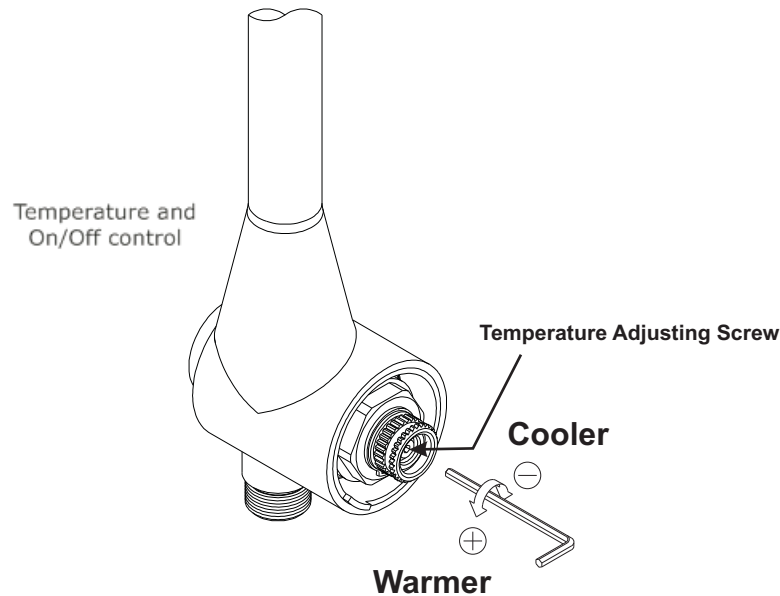

Service/Maintenance

If your thermostatic mixing valve fails to operate it could be the result of incorrect installation. Please refer to installation, site requirements and drawings on page 6. If the valve has operated correctly for a time, but no longer performs acceptably, it may require servicing/cleaning. Proceed as follows;

- 1) Isolate water supplies by turning shut offs on items (14+17) through 90° using a flat blade screwdriver, although a knife would be easier.
 - 2a) (Jute) Remove the button (1b) using a small flat screw driver to reveal the fixing grub screw (1a) the loosen using a 2.5mm allen key and remove the handle.
 - 2b) (Fuse) Unscrew the control lever (2b) to reveal the fixing grub screw (2a) the loosen using a 2.5mm allen key and remove the handle.
- 3) Remove the temperature headwork assembly using a 30mm A/F spanner / socket.
- 4) Remove the thermostat, piston assembly and spring (3).
- 5) Remove all visible 'o' rings and washers from the body.

