

# BRISTAN

TAPS & SHOWERS

## Installation Instructions & User Guide

Please leave these instructions with the end user

Product Code: R 1/2 TC (D2)

### Specifications

#### Dynamic Water Pressure (bar)

Min: 0.2 bar

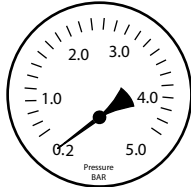

Max: 5.0 bar

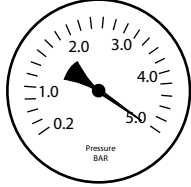

Maximum Static Pressure: 10.0 bar

### Tools You'll Need

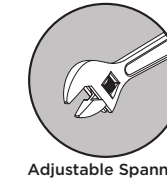
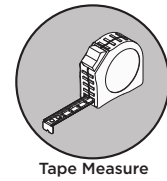

### Pack Contents

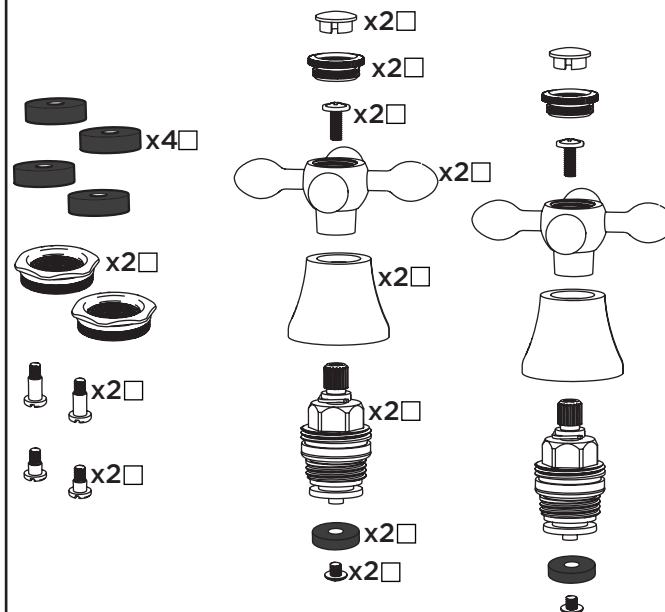

### Prior to Installation

All products manufactured and supplied by Bristan are safe provided they are installed, used correctly and receive regular maintenance in accordance with these instructions.

This product has been tested to the Water Regulations Advisory Scheme (WRAS) and satisfies the requirements of the Water Supply (Water Fittings) Regulations 1999 and current bylaws.

The replacement handles have a high quality finish and should be treated with care to preserve the visible surfaces.

All surface finishes will wear if not cleaned correctly, once your product has been used, dry it with a soft cloth. Your taps should be regularly cleaned with warm water, a mild pH-neutral liquid soap and polished with the microfiber cloth. This is gentle yet effective cleaning without scratching.

Any residues from soap and toothpaste can cause blemishes if not rinsed straight after use. Avoid using abrasive cloths, scouring pads, scrub sponges, steel wool or anything similar.

This product must not be modified in anyway as this will invalidate the guarantee.

### Installation

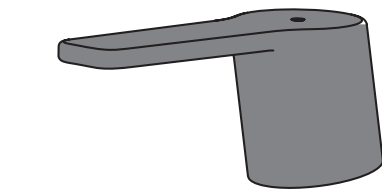

Remove the existing handles and valves.

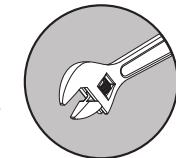

### Insert Selection

Insert the valve from the kit, if the thread fits follow the assembly chart on 1/2" 5412. See overleaf for chart.

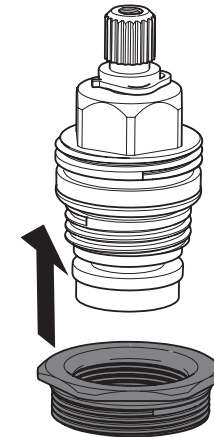

If the thread in body is larger then fit the 1/2" 1010 tap insert and follow assembly chart on 1/2" 1010 section.



### Spacer/Screw Selection

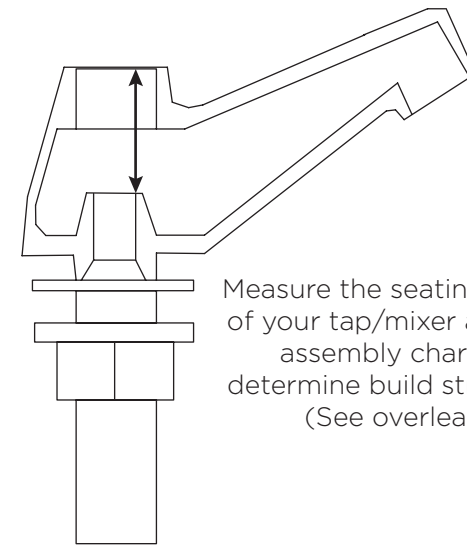

Measure the seating depth of your tap/mixer and see assembly chart to determine build structure. (See overleaf)

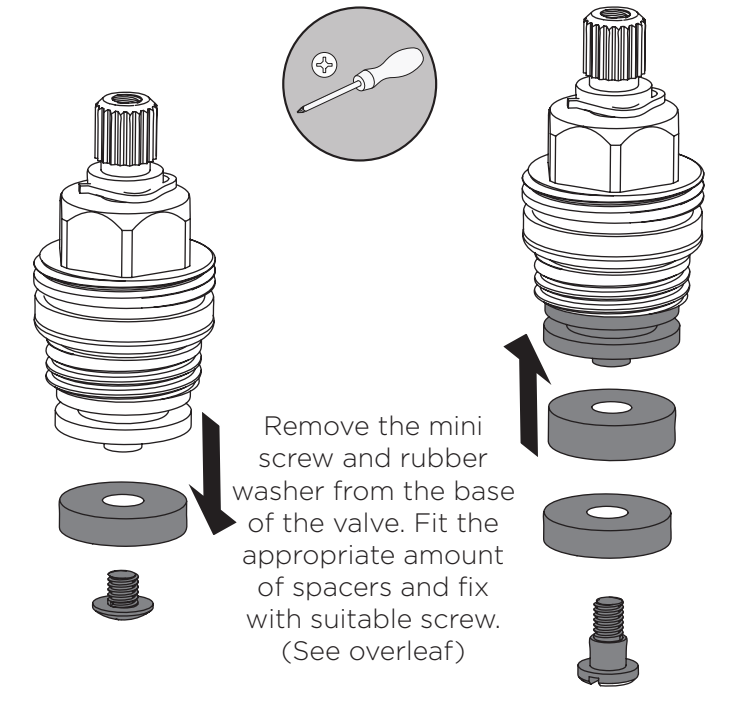
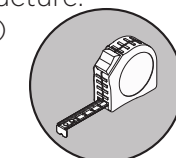

Remove the mini screw and rubber washer from the base of the valve. Fit the appropriate amount of spacers and fix with suitable screw. (See overleaf)

### Installation Continued

Tighten the valve into the tap body.

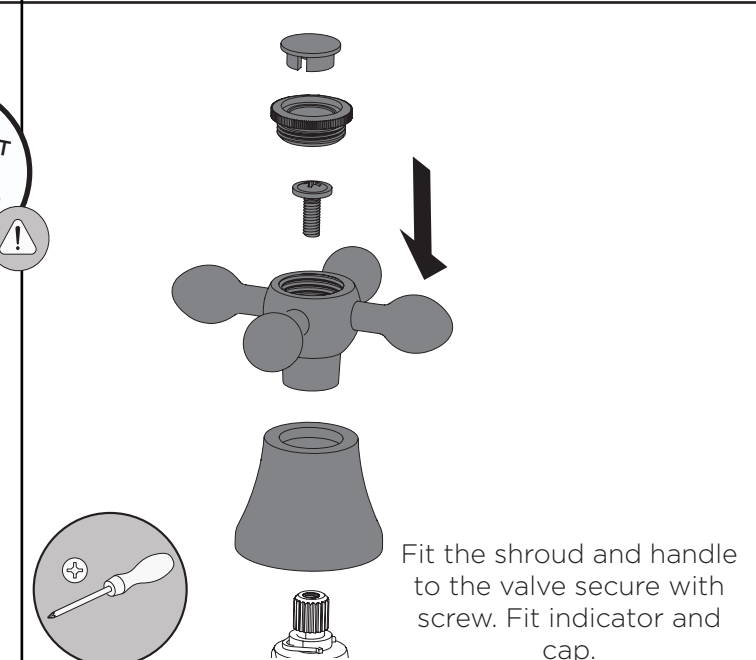
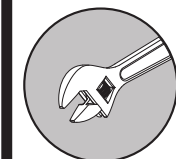
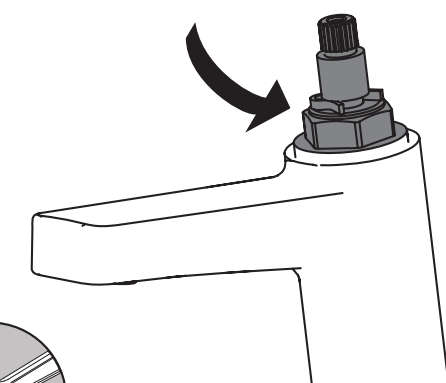

Fit the shroud and handle to the valve secure with screw. Fit indicator and cap.

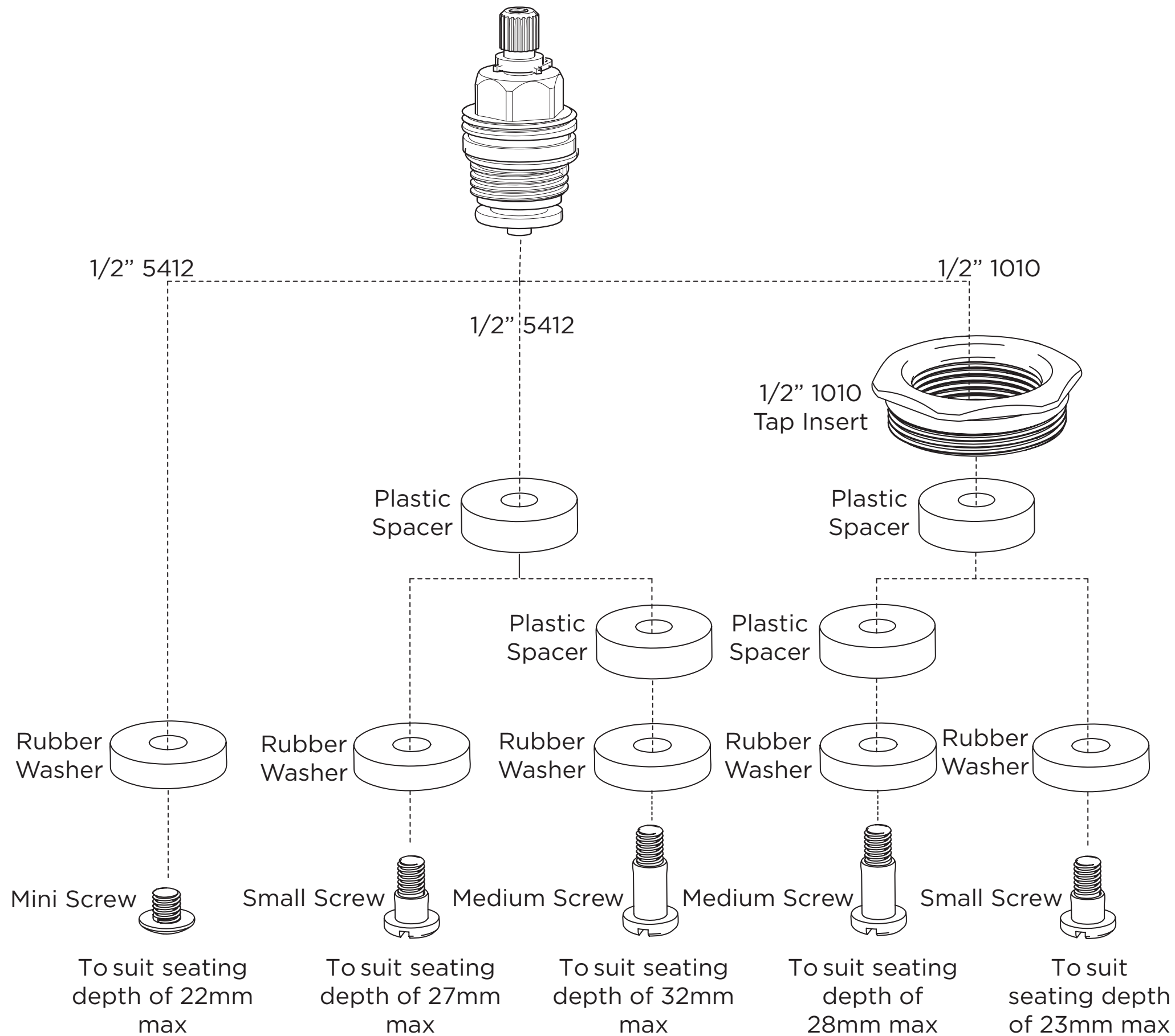

At Bristan, we want to make things as easy as possible for our customers. That's why we offer solid guarantees on all our products, effective from the date of purchase, to give you peace of mind.

To start your free guarantee simply scan the QR code and register your product. Alternatively visit [www.bristan.com/register](http://www.bristan.com/register).

For any other queries, please call our Customer Service on 0330 026 6273 where our expert team of advisors will be able to offer you any help and advice.

For full guarantee terms and conditions visit [www.bristan.com/guarantees](http://www.bristan.com/guarantees).



*We Know & We Care*