

INSTALLATION INSTRUCTIONS

Basin Mixer, with plug & chain (Excluding handles & bases) - T13

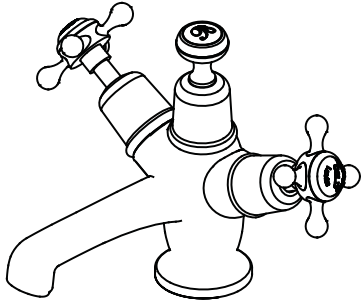

* The package in this product has no the handles or bases supplied.
The handles shown in the diagram are for reference only.

Option 1:

Burlington has 4 different style handle for your selection.

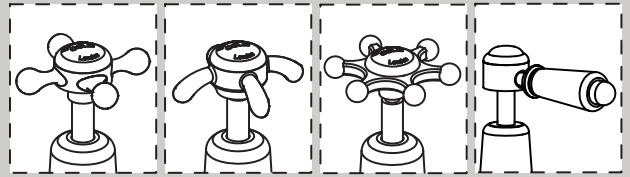

Claremont

Anglesey

Birkenhead

Kensington
(For Quarter turn only)

Option 2:

Burlington also have a base (27mm height) for your selection.

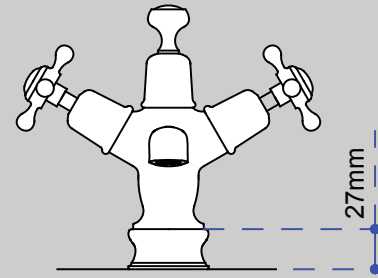

NOT INCLUDED IN THE TAP BOX

Important

- We recommend that this product is installed by a qualified professional contractor. Such as a plumber who is certified by NVQ (National Vocational Qualification) or SNVQ (Scottish National Vocational Qualification) Level 3
- Please check this product immediately to ensure that it has not been damaged and is complete. Before installation, please make sure this product is the correct model and you have all the parts required for installation and using.
- All the taps in Burlington Range should be supplied with hot and cold water at balanced pressure. If not, then the mixing function will not work correctly. It is necessary to fit non-return valves on both hot and cold feeds pipe. These are not supplied.
- Please flush the water system to ensure that no metal swarf, solder, and other impurities can enter the taps.
- Turn off water supply before commencing work, this should be done at the isolating valves of inlet feeds if fitted or main stopcock.
- Please read these instructions carefully and keep it for future reference.

Working pressure

The tap is suitable for both high and low pressure installation. To ensure that the tap works well under low water pressure, the cold water storage tank must be at least 2 meters above the installed position. The maximum static pressure is 10 bar, and operating water pressure is 5 bar. Where the operating water pressure above 5 bar, then a pressure reducing valve must be fitted.

Decoration heads (alternative option)

The tap comes with a factory-fitted decoration head at the center of tap, and also has an alternative decoration head for your option.

If it is needed to replace, please screw off the factory-fitted decoration head, and screw on the spare one.

Straightener and aerator (alternative option)

The tap comes with a factory-fitted flow straightener for low pressure water systems. If the water flow is high, replace the factory-fitted flow straightener with the high pressure aerator supplied.

Use NEOPERL Key to unscrew the straightener in the Nozzle. Replace with the aerator provided, and screw back in nozzle tightly. (If you misplace the Neoperl key you can use the top of the aerator/straightener as a key)

Cleaning

Before use: Unscrew the filter and allow the water to run freely for 5 minutes. Then screw the filter back in place.

Periodically: Using the key provided unscrew the nozzle and remove. Rinse it with cleaning running water until any loose debris is cleared. Then replace the nozzle and tighten with key provided.

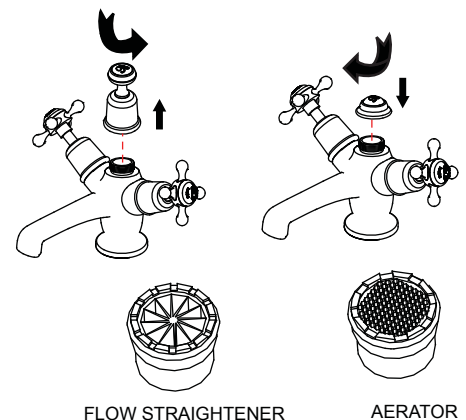

FLOW STRAIGHTENER

AERATOR

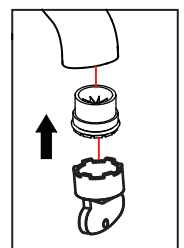
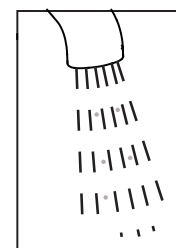
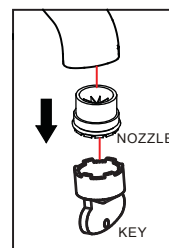

Dimension

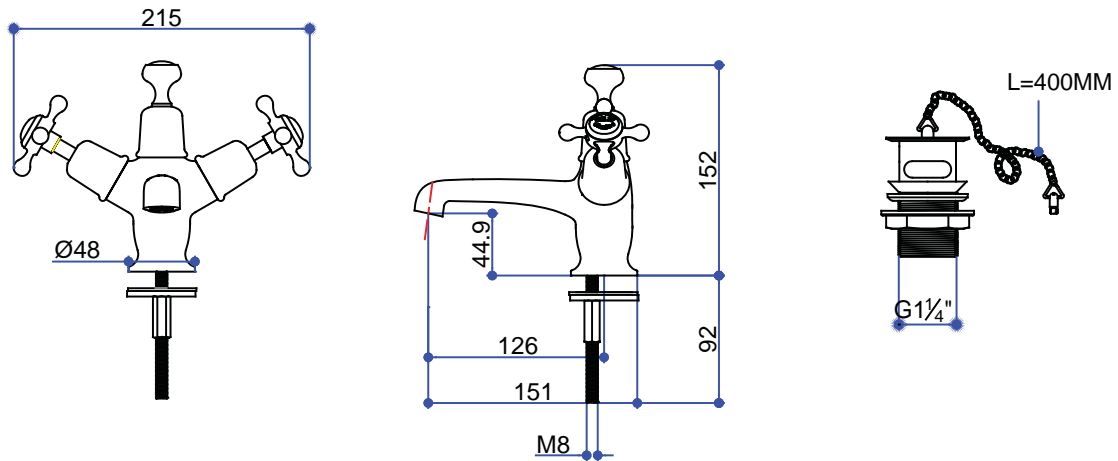

Installation

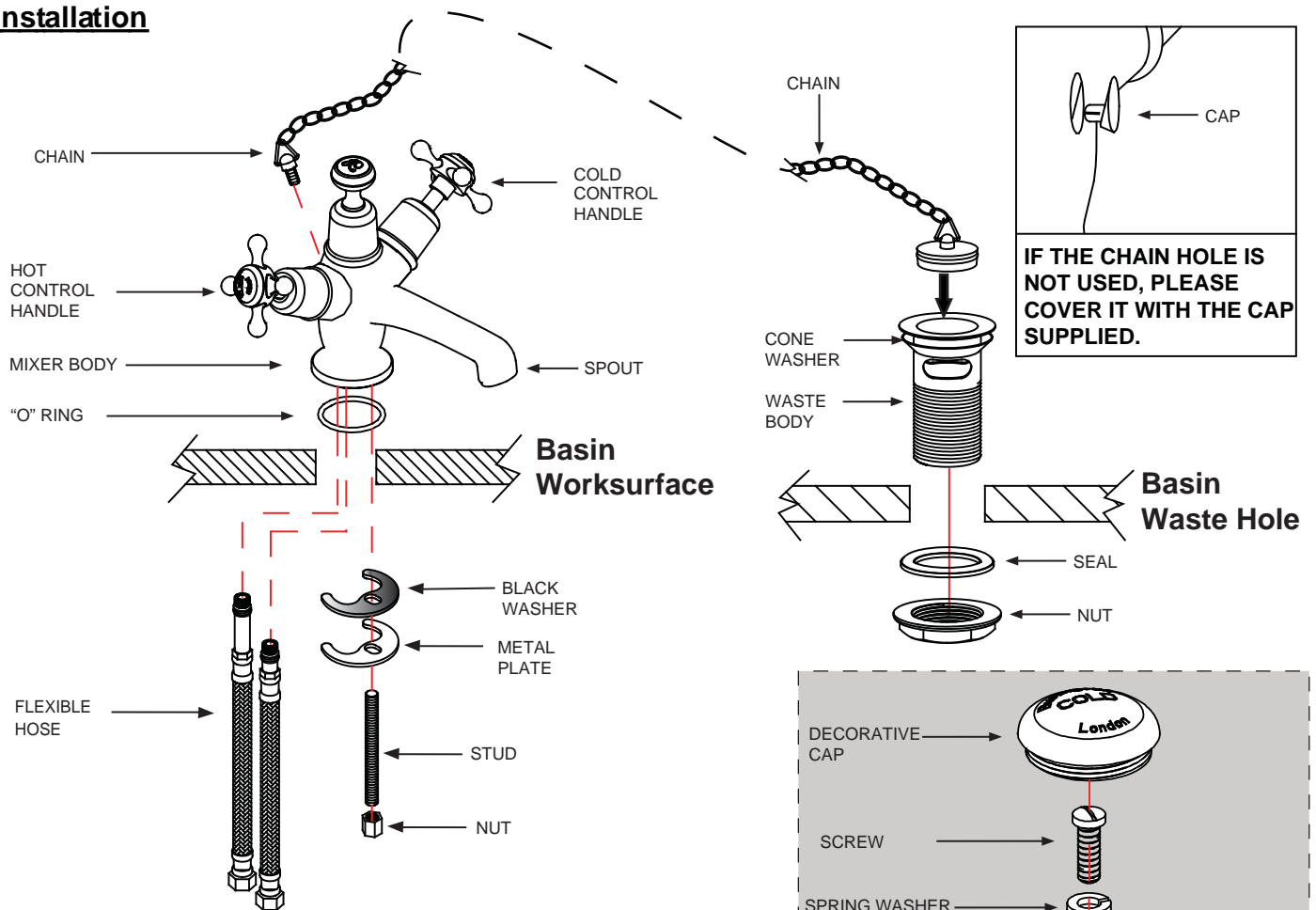

1. Fit the "O" ring into the groove on the underside of the mixer body.
2. Screw and tighten two flexible hose into the mixer body.
3. Loosen the nut from stud and screw the stud into the base of mixer.
4. Pass the flexible hoses and stud through the hole in basin. Slide the black washer and metal plate onto the stud. Then screw on the nut and tighten the mixer on basin.
5. Install Plug & Chain waste:
 - a) There is a small tip screw on the top of waste chain.
 - b) Screw on the tip screw into the chain hole on the backside of tap.
 - c) Put the nut back to screw and tighten it on the backside of basin.
 - d) Insert the plug waste in the basin waste hole and tighten.
 - e) Shear the chain if it's too long in your basin.

Note: To ensure the Kensington lever tap head faces in the correct forward position once installed, you may need to tighten the cartridge into the tap body a notch with a monkey spanner and then re-attach the tap head.

Maintenance

We do NOT recommend you use any household cleaners to clean the product. Because these cleaners change substance or formula too frequently. The product should be always cleaned only with soapy water and rinsed with clean water and dried with a soft cloth.