



## **FP735Si**

*Electronic 3-Channel Full Programmer for Heating and Hot Water with Service Interval Timer*

**For a large print version of these instructions  
please call Marketing on 0845 121 7400.**



Certification Mark

This product complies with the following EC Directives:  
Electro-Magnetic Compatibility Directive.  
(EMC) (2004/108/EC)  
Low voltage Directive.  
(LVD) (2006/95/EC)



Danfoss can accept no responsibility for possible errors in catalogues, brochures, and other printed material. All trademarks in this material are property of the respective companies. Danfoss and the Danfoss logotype are trademarks of Danfoss A/S. All rights reserved.

# Installation Instructions

## FP735Si

*Electronic 3-Channel Full Programmer for Heating and Hot Water with Service Interval Timer*

GB



## Index

<b>1.0</b>	<b>Installation Guide</b> .....	4
<b>2.0</b>	<b>System Overview</b> .....	4
<b>3.0</b>	<b>Installation</b> .....	5
	3.1 Removing the wallplate .....	5
	3.2 Installation considerations .....	5
	3.3 Wiring .....	5
	3.3 Mounting the unit .....	6
	3.4 Unit startup .....	6
<b>4.0</b>	<b>Programming Options</b> .....	6
	4.1 Normal programming .....	6
	4.2 Advanced programming .....	7
<b>5.0</b>	<b>Pre-programmed Parameters</b> .....	8
	5.1 Advanced programming .....	8
	5.2 Normal programming .....	8
<b>6.0</b>	<b>Display Information</b> .....	10
<b>7.0</b>	<b>Advanced Programming</b> .....	11
<b>8.0</b>	<b>Service Interval Timer</b> .....	14
<b>9.0</b>	<b>Copy Functions</b> .....	14
<b>10.0</b>	<b>The Information Key</b> .....	16
<b>11.0</b>	<b>How to Reset The Unit</b> .....	16
	11.1 Reset .....	16
	11.2 Full reset .....	17
<b>12.0</b>	<b>System Wiring Example</b> .....	18

# 1.0 Installation Guide

---

## Please Note:

*This product should only be installed by a qualified electrician or competent heating installer and should be in accordance with the current edition of the IEEE wiring regulations.*

**GB**

## 2.0 System Overview

---

<b>Timer Features</b>	<b>FP735Si</b>
Power supply	230V, 50Hz
Memory backup	Retained for the life of the product
Factory set calendar clock	Automatic summer/winter time change
Switching action of output relay	2 x SPDT, 1 x SPST, Type 1B
Switch rating of relay contact	3 x 3(1) A, 230 VAC
Rated Impulse Voltage	2.5 kV
Dimensions (mm)	140 wide x 91 high x 29 deep
Ball Pressure Test	75°C
Design Standard	EN 60730-2-7
Control Pollution Situation	Degree 2
Time accuracy	± 1 minute per month
IP rating	IP30
Software Classification	A

## 3.0 Installation

3.1 First remove the wallplate from the back of the unit.

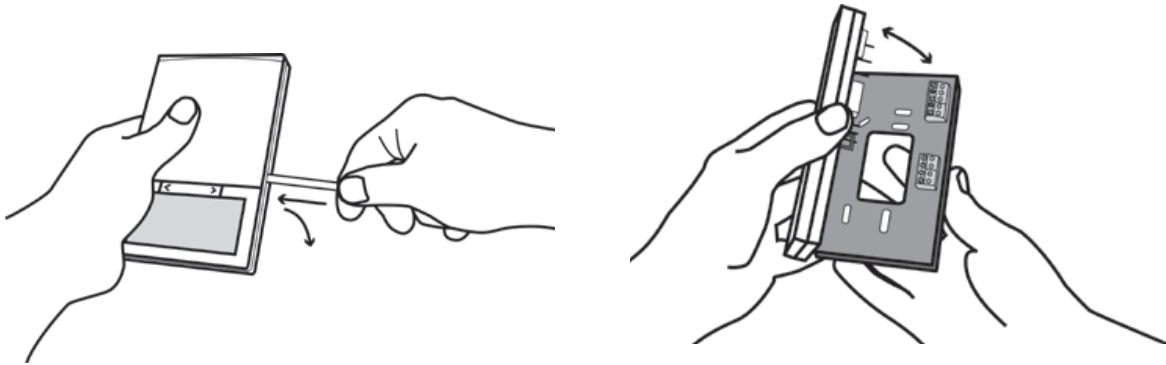

GB

3.2 From the top left hand corner of the wallplate, there must be clearances of at least 21mm to the right, 21mm to the left, 36mm above and 106mm below in order to mount the plug-in module.

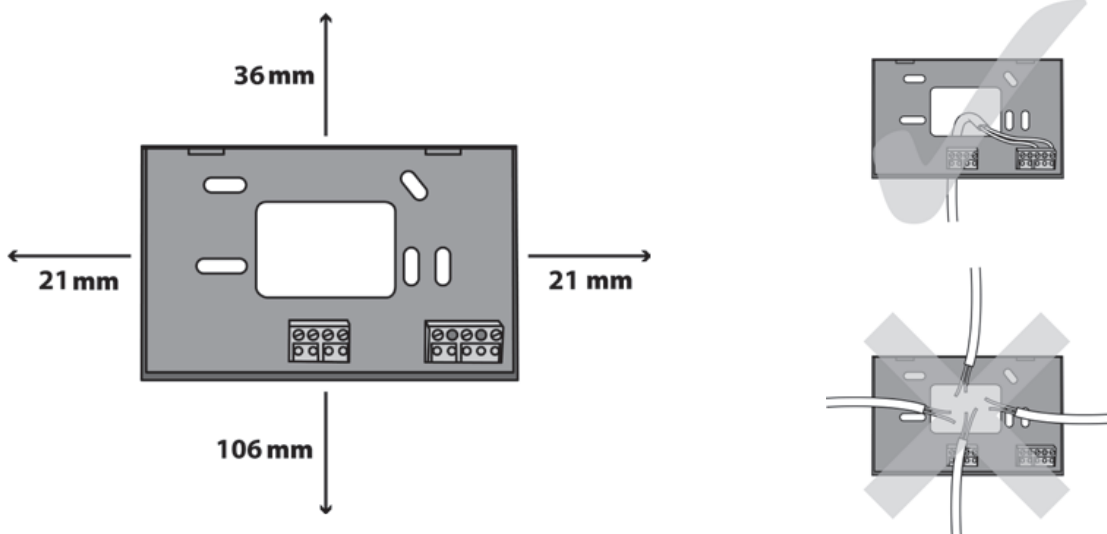

3.3 Wiring

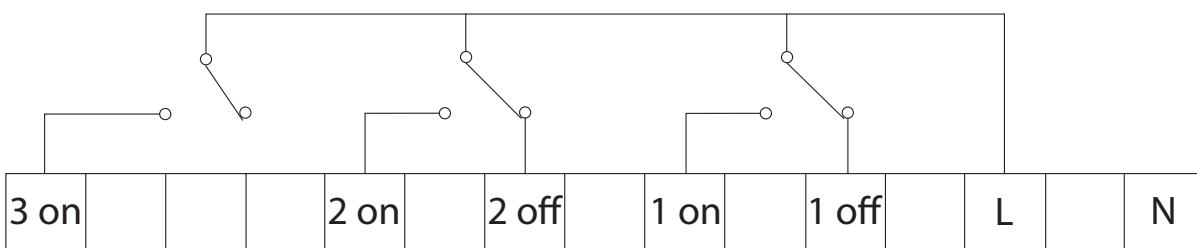

Note: A typical system wiring example is shown on page 18

### 3.4 Mount the unit on the wallplate

GB

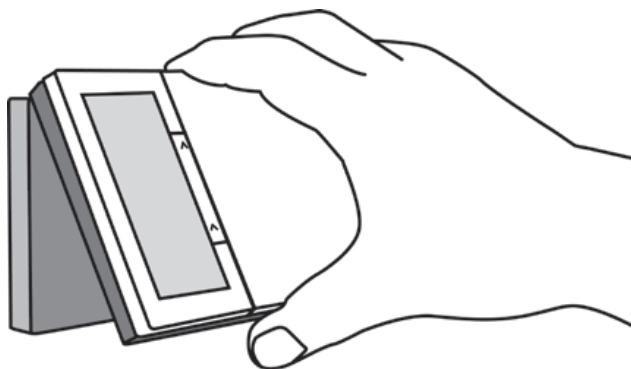

**Note:** Always switch the mains off first and never fit/remove the timer to/from a live wallplate.

3.5 With the unit powered up, it is recommended to press and release the **RESET** button to start up the FP735Si unit.

## 4.0 Programming Options

---

FP735Si is delivered with a set of parameters that have been pre-programmed to cover the most typical type of installations. See (5.0). If a different parameter setup is wanted the unit provides two programming options:

### 4.1 Normal programming

Normal Programming is meant for setting the timing profile that controls the ON and OFF periods for the room heating and for the hot water. A daily profile may be programmed and a profile can control the entire week where the weekend may be handled separately. Also a timing profile for a holiday can be entered.

As part of the normal daily operations, a simple one-button press (+HRS) can extend a running ON period for room heating and/or hot water by one hour. This can be repeated 3 times giving up to 3 hours extension.

By pressing ADV (advance), the user can jump to the next event in the daily timing profile. If for instance, the user wants to bring on the room heating immediately whereas the profile has been programmed to bring it on in two hours, the user can simply press ADV and the heat will be turned on.

See the User Guide for normal programming instructions.

**GB**

## **4.2 Advanced Programming**

Advanced Programming is meant for changing certain parameters that are usually only set once. Advanced Programming can typically be made by the installer as part of the system installation and setup.

## 5.0 Pre-programmed Parameters

FP735Si is delivered with a set of pre-programmed parameters.

### 5.1 Advanced Programming

GB

The following pre-programmed parameters can be changed in the **Advanced Programming**:

Function/parameter	Pre-programming
A+B days (disabled, enabled)	Disabled
Copy functions (standard or advanced copy function)	Standard
Summer/winter shift (automatic or manual)	Automatic
Backlight (always off, always on, 15s after last key press)	15s after last key press
4 events or 6 events per day	6 events
Operating mode (7 days, 24 hours, 5 + 2 week days)	7 days
Keyboard lock (locked, not locked)	Not locked
Service interval (disabled, enabled)	Disabled

Note: for the UK market, the FP735Si comes with a default 12 hours clock (AM/PM) setup.

### 5.2 Normal Programming

The following pre-programmed parameters can be changed in the **Normal Programming**. See User Guide.



Pre-programmed ON and OFF periods for 6 events per day:  
Weekdays (Monday-Friday):

<b>Event</b>	<b>Time</b>	<b>Room heating/water heating status</b>
1	06:30	ON
2	08:30	OFF
3	11:30	ON
4	13:30	OFF
5	16:30	ON
6	22:30	OFF

**GB**

Weekends (Saturday-Sunday):

<b>Event</b>	<b>Time</b>	<b>Room heating/water heating status</b>
1	07:30	ON
2	09:30	OFF
3	11:30	ON
4	13:30	OFF
5	16:30	ON
6	22:30	OFF

Pre-programmed ON and OFF periods for 4 events per day  
Weekdays (Monday-Friday):

<b>Event</b>	<b>Time</b>	<b>Room heating/water heating status</b>
1	06:30	ON
2	08:30	OFF
3	16:30	ON
4	22:30	OFF

Weekends (Saturday-Sunday):







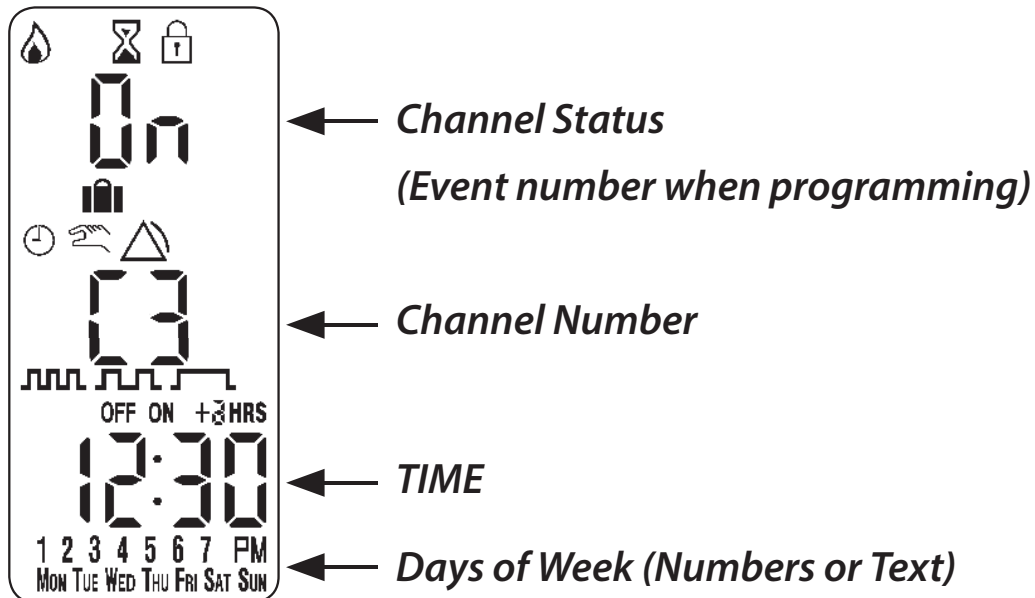



<b>Event</b>	<b>Time</b>	<b>Room heating/water heating status</b>
1	07:30	ON
2	09:30	OFF
3	16:30	ON
4	22:30	OFF

## 6.0 Display Information

GB



### KEY TO SYMBOLS

	Flame: shows when heating is on
	Hourglass: shows during programming delays
	Padlock: indicates keyboard is locked
	Suitcase: indicates Holiday Mode is set
	Clock: Timed Modes
	Hand: Manual Modes
	Alarm: Indicates alarm is active. Also used for service due
	3 on and 3 off events per day
	2 on and 2 off events per day
	1 on and 1 off event per day. All Day Mode
<b>OFF</b>	Timer (OFF) Mode
<b>+ 3HRS</b>	+ HRS: Extends function by 1, 2 or 3 hours
<b>ON</b>	Timer (ON) Mode

## 7.0 Advanced Programming

---

To access the Advanced Programming follow the steps below:

- a) Press and hold **PROG** and **V** for 5 seconds.  
The display will change to look like this.

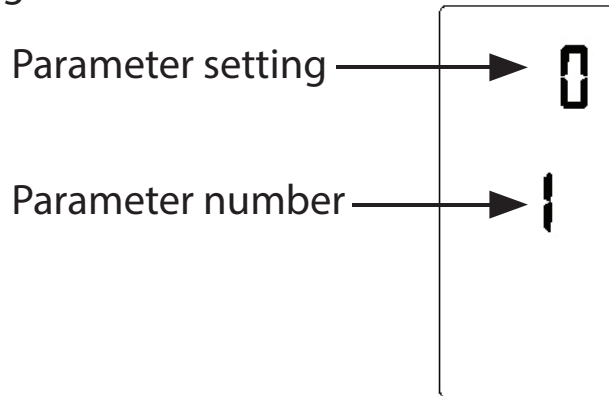

- b) Press the + and - keys to scroll backwards and forwards between parameters.  
Press the **V** and **Λ** keys to change the parameter setting.

The flashing digits in the center of the display indicate the number of the selected option. The large characters in the top or bottom of the display indicate the option value selected.

- c) Press and hold **PROG** until the display returns to **RUN** mode.

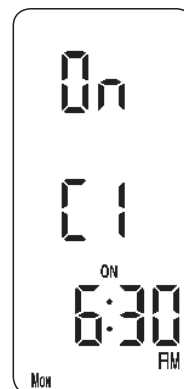

GB

In the Advanced Programming mode, the following parameters can be changed:

**GB**

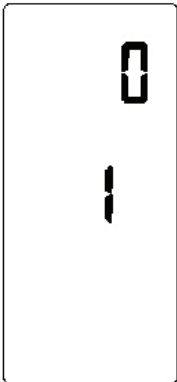
<b>Parameter 1 – Enable/Disable A+B Days</b>	
<p>This allows the unit to operate in A+B days. A and B days can be grouped arbitrarily: 5+2, 4+3, etc. The days do not have to run in sequence. Press + until parameter 1 is displayed. Press <b>V</b> or <b>Λ</b> to select the required setting.</p> <p><b>Note:</b> A+B setting is only possible if operating mode 5+2 has been set in Advanced Programming.</p> <p><b>WARNING:</b> Changing this parameter will reset event times to default values.</p>	
0 = disabled (default)	
1 = enabled	

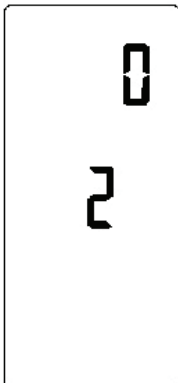
<b>Parameter 2 – Copy functions</b>	
<p>This parameter sets the unit to operate with the Standard Copy function or the Advanced Copy function. Press + until parameter 2 is displayed. Press <b>V</b> or <b>Λ</b> to select the required setting.</p> <p><b>Note:</b> Advanced Copy setting is only possible if operating mode 7 day has been set in Advanced Programming.</p>	
0 = Standard Copy (default)	
1 = Advanced Copy	

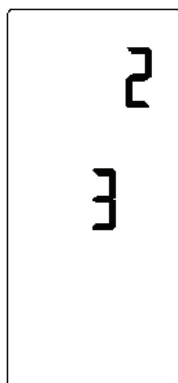
<b>Parameter 3 – Summer/winter</b>	
<p>The Summer/winter parameter makes it possible to let the unit change between summer and winter period automatically or manually. The parameter can also disable the change between summer and winter.</p> <p>Press + until parameter 3 is displayed. Press <b>V</b> or <b>Λ</b> to select the required setting.</p>	
0 = disable summer/winter change	
1 = enable manual summer/winter change	
2 = enable automatic summer/winter change (default)	

<p><b>Parameter 4 – Backlight</b></p>	
<p>The backlight parameter allows the backlight to be always on, always off, or on for 15 seconds after the last key press.</p> <p>Press + until parameter 4 is displayed. Press <b>V</b> or <b>Λ</b> to select the required setting.</p>	
<p>0 = backlight always off</p>	
<p>1 = backlight on for 15 seconds after the last key press (default)</p>	
<p>2 = backlight always on</p>	

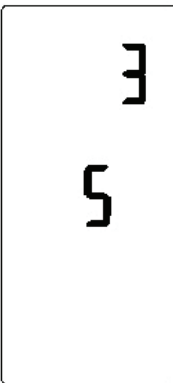
<p><b>Parameter 5 – Number of events per day</b></p>	
<p>This parameter sets the unit to operate with 4 or 6 events per day. An event being an ON or an OFF period of room heating and/or hot water heating.</p> <p>Press + until parameter 5 is displayed. Press <b>V</b> or <b>Λ</b> to select the required setting.</p> <p><b>WARNING:</b> Changing this parameter will reset event times to default values.</p>	
<p>2 = 2 ON/OFF periods per day</p>	
<p>3 = 3 ON/OFF periods per day (default)</p>	

<p><b>Parameter 6 – Operating Mode (7 Day, 5+2 Day or 24 Hour)</b></p>	
<p>This parameter sets the unit to operate using either 7 day, 5+2 day or 24 hour mode.</p> <p>Press + until Option 6 is displayed. Press <b>V</b> or <b>Λ</b> to select the required setting.</p> <p><b>WARNING:</b> Changing this parameter will reset event times to default values.</p>	
<p>24 = 24 hour</p>	
<p>5-2 = 5+2 Day (or A+B if set in parameter 1)</p>	
<p>7 = 7 day (default)</p>	

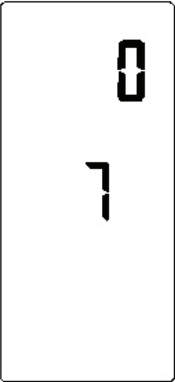
<b>Parameter 7 – Keyboard Lock</b>	
<p>This parameter sets the unit to operate with an enabled (functioning) or a disabled (locked) keyboard.</p> <p>Press <b>+</b> until parameter 7 is displayed Press <b>V</b> or <b>Λ</b> to select the required setting.</p>	
0 = the keyboard is enabled (default)	
1 = the keyboard is disabled (locked)	

## 8.0 Service Interval Timer

The FP735Si is equipped with an installer setback service interval timer. If this feature is required please contact our technical department. Setting instructions for this gas safety feature are only available to bona fide heating installers.

## 9.0 Copy Functions

FP735Si provides 3 copy functions: **Standard Copy**, **Advanced Copy** and **Channel Copy**. **Standard Copy** is the default setting. If the **Advanced Copy** function is wanted, it must be changed in Advanced Programming mode (page 13). **Channel Copy** is always available.

### Standard Copy

Pressing **COPY/i** will copy the previous day's events into the displayed day. The unit will then display the 1st event for the new day.

The Standard Copy function is only present if the unit is set to run in **7 day mode**, or 5+2 day mode.

To perform a standard copy operation:

- a) Press **CH** to select the channel.
- b) Press **PROG** to go to event programming.
- c) Press **DAY/HOL** to select the day to copy to.
- d) Press **COPY/i** to copy the previous day's events to the displayed day.

**GB**

### **Advanced Copy**

The Advanced Copy function is available in **7 day mode** only. This allows any day to be copied to any other day, or days.

To use the Advanced Copy function, go into the event programming using the **PROG** button, then:

- 1) Press **DAY/HOL** to select the day to be copied from.
- 2) Press **COPY/i** to copy from the selected day.  
When selected, the day will begin to flash.
- 3) Press **DAY/HOL** to select the day to be copied to.
- 4) Press **COPY/i** to copy to the selected day.
- 5) Repeat steps 3 and 4 to select and copy other days.
- 6) To stop copying, use the **DAY/HOL** button to go back to the flashing day and press the **COPY/i** button. The previously flashing day will stop flashing to indicate it has been de-selected.

**NOTE:** When a day has been copied to, it will remain visible and not flashing when the **DAY/HOL** button is used to select other days.

### **Channel Copy**

Channel Copy is used to copy events from one channel to another channel.

To perform a Channel Copy operation:

- a) Press **CH** to select the channel to copy to.
- b) Press **COPY/i** to copy from the previous channel.

## 10.0 The Information Key

---

When running in normal operation, the Information key **COPY/i** will provide the following information:

**GB**

- 1<sup>st</sup> **COPY/i** key press: the model number is displayed.
- 2<sup>nd</sup> **COPY/i** key press: the software version is displayed.
- 3<sup>rd</sup> **COPY/i** key press: the next event time is displayed.
- 4<sup>th</sup> **COPY/i** key press: the Service Due end date is displayed (if set).

In holiday mode, the information key will provide the holiday end date only.

**Note:** the first **COPY/i** key press will only turn on the backlight if no keys have been pressed for 2 minutes.

## 11.0 How to Reset The Unit

---

FP735Si has three levels of reset:

Reset  
Full Reset

### 11.1 Reset

Reset restores operation in the unlikely event that the unit has become unresponsive.

Press and release the **RESET** button.

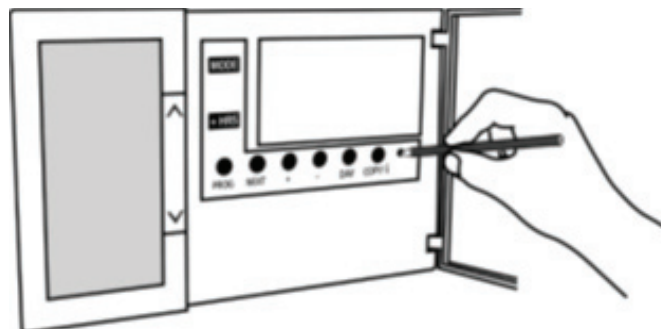



This does not reset any programmes or the time or date, but will cancel any manual overrides that have been selected.

## 11.2 Full Reset

- 1) Go to Advanced Programming: press and hold **PROG** and **V** for 5 seconds.
- 2) Press and hold **PROG** and press/release **R/S**.

**GB**

At a Full Reset:

- Event times are reset to their default values (section 5.2).
- Next event overrides are cancelled.
- +HRS overrides are cancelled.
- Pre-programmed Parameters (see 5.1) are reset to default values.
- Time and date are not changed.

## 12.0 System Wiring Example

3.3 For wiring connections please refer to the diagram below:

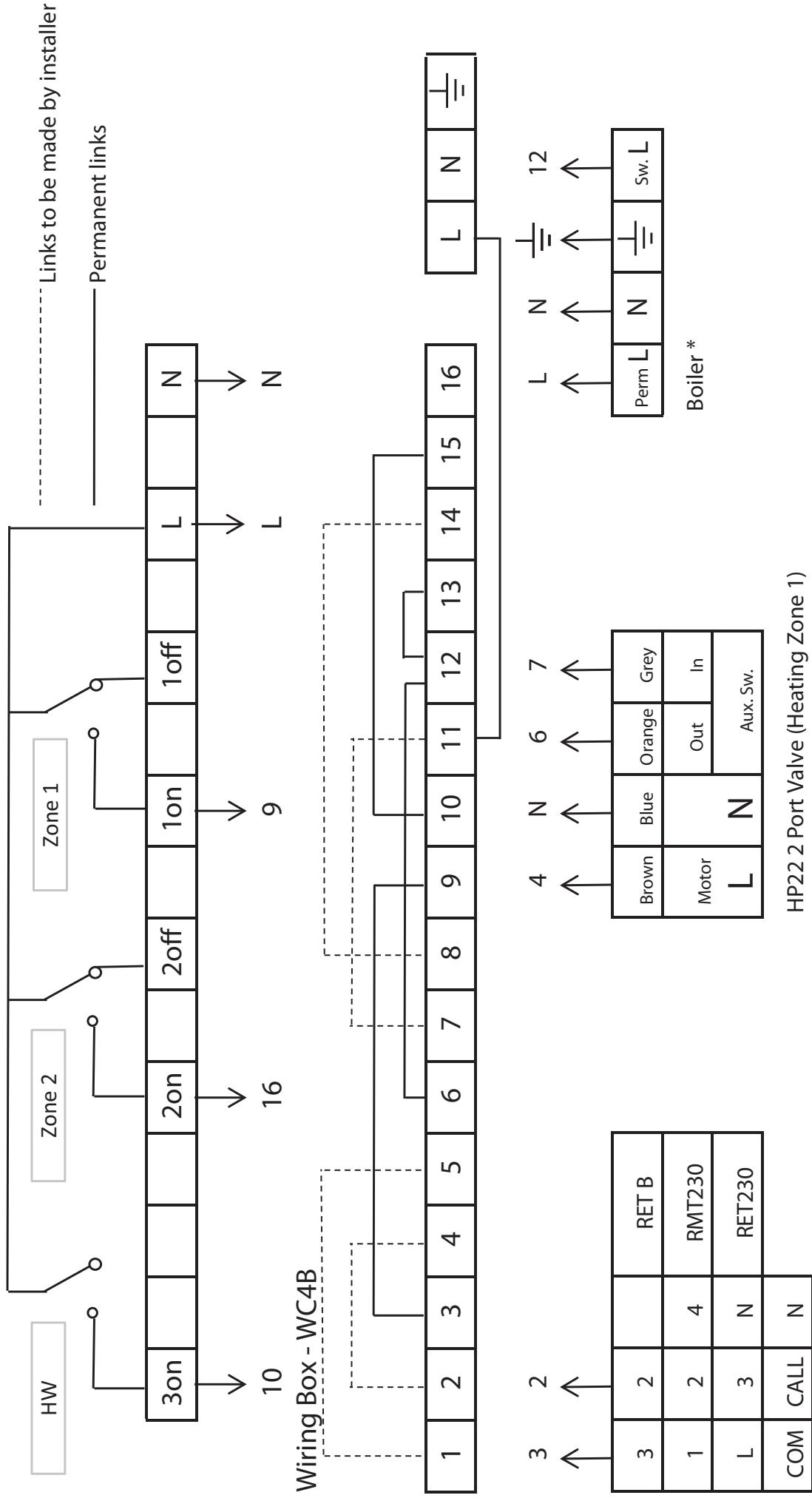

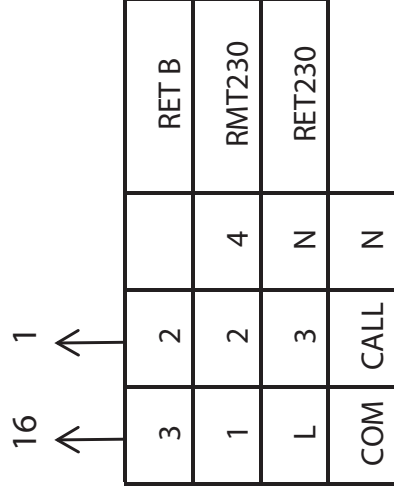

Room Thermostat - Zone 2

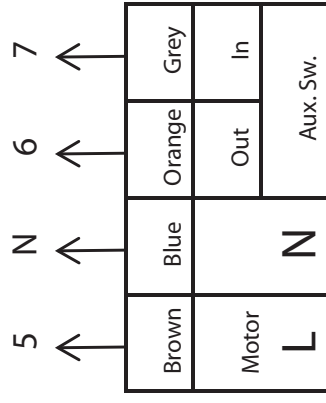

HP22 2 Port Valve (Heating Zone 2)

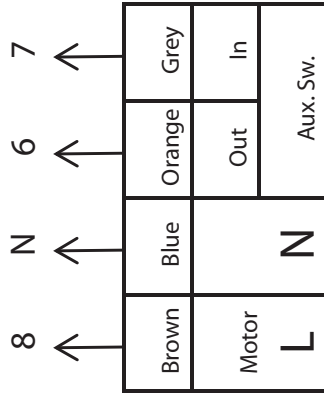

HP22 2 Port Valve (Hot Water)

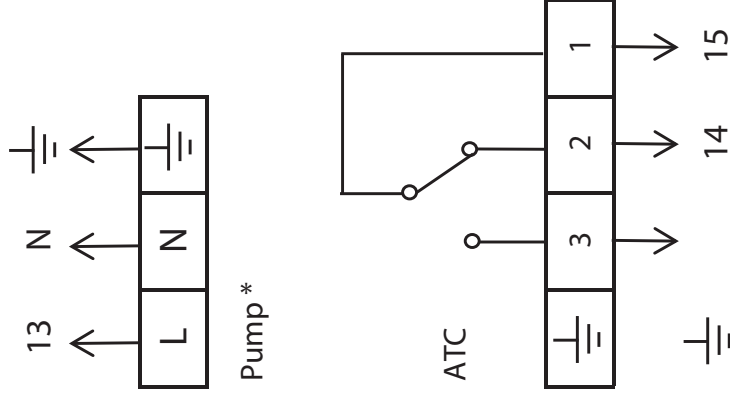

The above wiring diagram refers to a 3 Zone system using 3x2 port valves to control flow to each heating zone and the hot water. For systems using 3 port valves or a combination of 2 and 3 port valves please consult your local Danfoss contact.

\* Refer to boiler wiring information for boilers with pump overrun





**Danfoss Ltd.**

Ampthill Road

Bedford MK42 9ER

Tel: 0845 1217 400

Fax: 0845 1217 515

Email: [ukheating@danfoss.com](mailto:ukheating@danfoss.com)

Website: [www.heating.danfoss.co.uk](http://www.heating.danfoss.co.uk)