

Sales Code: OFF506

Description: 500 Vanity Unit (355mm Deep)

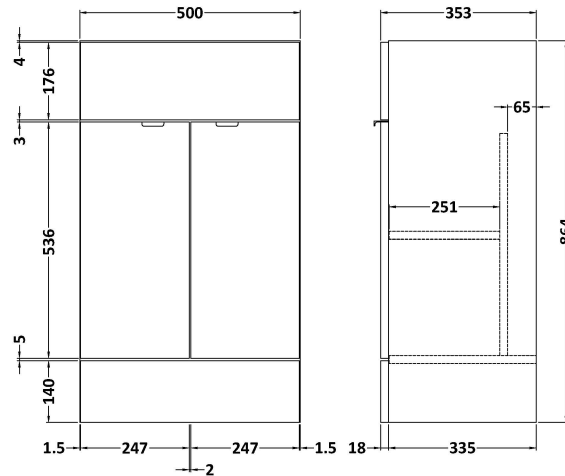

Product Dimensions

Height (mm):	864
Width (mm):	500
Depth (mm):	355
Nett Weight (kg):	18

Packaging Dimensions

Height (mm):	375
Width (mm):	520
Depth (mm):	900
Gross Weight (kg):	18.5

Packaging Data

Box Colour:	Brown Cardboard Box
Box Qty:	1
Label Size:	100 x 50
Label Colour:	White Label
Label Qty:	2

Outer Box Dimensions (If Applicable)

Height (mm):	
Width (mm):	
Depth (mm):	
Gross Weight (kg):	
Barcode:	5055275820186

Product Details

Country of Origin:	United Kingdom
Fitting Instruction:	No
CE & UKCA:	N/A
FSC Certified Materials:	Yes
Colour:	Anthracite Woodgrain
Construction Method:	Cam & Wood Dowel
Construction Type:	Rigid
Cabinet Finish:	MFC Textured Woodgrain
Fascia Finish:	MFC Textured Woodgrain
Cabinet Thickness (mm):	18
Fascia Thickness (mm):	18
Drawer Included:	No
Drawer Type:	Not Applicable
No of Shelves:	1
Hinge Type:	95 Degree Clip-On Soft Close
Hinge Included:	Yes
Adjustable Legs:	No
Fixings Included:	Yes
Handle Style:	Contemporary
Waste Shroud:	No
Handle Included:	Yes
Handle Type:	Wrapover