

Sales Code: HSA008

Description: Salvia Radiator 635X863mm

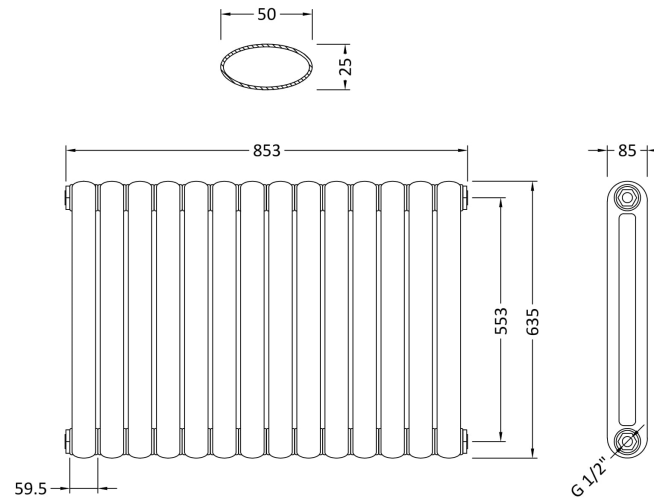

Product Dimensions

Height (mm):	635
Width (mm):	863
Depth (mm):	80
Length (mm):	
Nett Weight (kg):	29.04

Packaging Dimensions

Height (mm):	100
Width (mm):	695
Length (mm):	920
Gross Weight (kg):	29.04

Packaging Data

Box Colour:	White Cardboard Shrinkwrapped
Box Qty:	1
Label Size:	100 x 50
Label Colour:	White Label
Label Qty:	2

Outer Box Dimensions (If Applicable)

Height (mm):	
Width (mm):	
Length (mm):	
Gross Weight (kg):	
Barcode:	5055369023233

Product Details

Country of Origin:	China		
Fitting Instruction:	No		
Certification:	CE & UKCA: No	RoHS: N/A	WEEE: N/A
Colour/Finish:	Anthracite		
RAL No:	7016		
Product Material:	Steel		
Heat Element Wattage:	Not Applicable		
Heating Element Wattage Compatible:	N/A		
BTU Outputs:	30°C / 1635	50°C / 3129	60°C / 3964
Thermal Outputs: (Watts)	30°C / 479	50°C / 917	60°C / 1155
Pipe Centres - If Vertical:	953mm		
Pipe Centres - If Horizontal:	N/A		
Max Projection:	120mm		
Tube Diameter:	N/A		
Packaging Volume (L):			
Wall to Centre of Tappings:	N/A		
Floor to Centre of Tappings:	80		
Dual Fuel:	N/A		
IP Rating:			