

Sales Code: NBV180

Description: Rectangular Basin 465 X 235 X 120

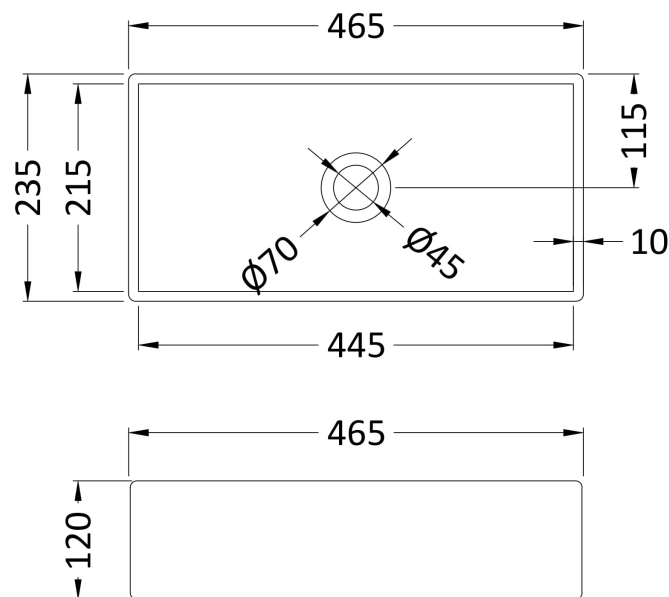

Product Dimensions

Height (mm):	120
Width (mm):	465
Depth (mm):	235
Nett Weight (kg):	7.5

Packaging Dimensions

Height (mm):	135
Width (mm):	475
Depth (mm):	245
Gross Weight (kg):	8

Packaging Data

Box Colour:	Brown Cardboard Box
Box Qty:	1
Label Size:	100 x 50
Label Colour:	White Label
Label Qty:	2

Outer Box Dimensions (If Applicable)

Height (mm):	
Width (mm):	
Depth (mm):	
Gross Weight (kg):	
Barcode:	5056211851622

Product Details

Country of Origin:	China
Fitting Instruction:	No
Certification: CE & UKCA:	WRAS: WRAS No:
Product Material:	Vitreous China
Fixing Supplied:	No

Pans/Bidets: Trap Style: N/A Includes Seat: Not Applicable

Seats: Seat Type: N/A Material: Not Applicable
Function: Not Applicable Hinge Type: Not Applicable
Hinge Material: Not Applicable

Cisterns: Operating Type: Not Applicable Fittings: Not Applicable
Lever Type: N/A

Basins: Tap Hole: No Tapholes Chain Stay Hole: No
Template: Not Required Waste Type Req: Unslotted
Overflow Inc: No Overflow Cover: No
Inner Bowl Depth (mm): 110mm