

**Sales Code:** Cbw001

**Description:** Linton Back To Wall Pan And Seat

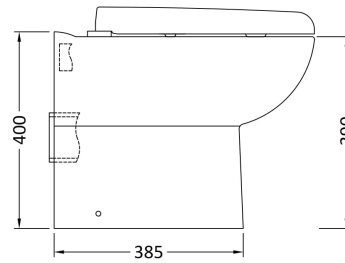
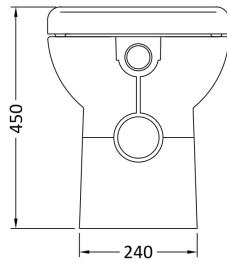
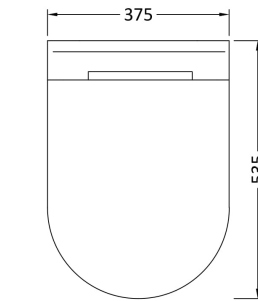

**Packaging Details**

Barcode: 5055275895788

Sales Code: BTW005

Description: Lawton Back To Wall Pan

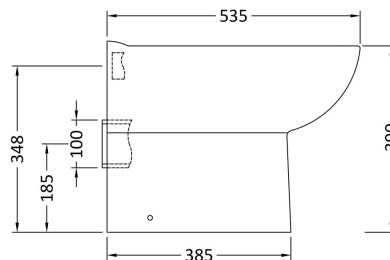
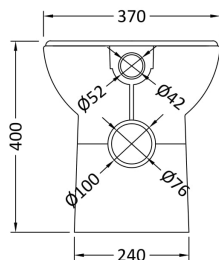
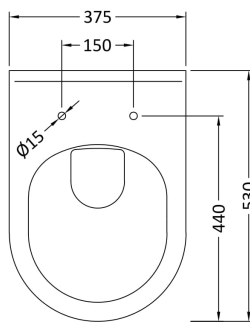

### Product Dimensions

Height (mm):	400
Width (mm):	375
Depth (mm):	535
Nett Weight (kg):	22.1

### Packaging Dimensions

Height (mm):	420
Width (mm):	395
Depth (mm):	540
Gross Weight (kg):	22.6

### Packaging Data

Box Colour:	Brown Cardboard Box - Printed
Box Qty:	1
Label Size:	100 x 50
Label Colour:	Not Applicable
Label Qty:	2

### Outer Box Dimensions (If Applicable)

Height (mm):	
Width (mm):	
Depth (mm):	
Gross Weight (kg):	
Barcode:	5055369032907

### Product Details

Country of Origin:	China
Fitting Instruction:	No
Certification: CE & UKCA:	Yes WRAS: N/A WRAS No: N/A
Product Material:	Vitreous China
Fixing Supplied:	No

**Pans/Bidets:** Trap Style: P Trap Includes Seat: No

**Seats:** Seat Type: D-Shape Material: Not Applicable  
 Function: Not Applicable Hinge Type: Top Fix  
 Hinge Material: Not Applicable

**Cisterns:** Operating Type: Not Applicable Fittings: Not Applicable  
 Lever Type: Not Applicable

**Basins:** Tap Hole: Not Applicable Chain Stay Hole: Not Applicable  
 Template: Not Applicable Waste Type Req: Not Applicable  
 Overflow Inc: Not Applicable Overflow Cover: Not Applicable  
 Inner Bowl Depth (mm): N/A

Sales Code: NTS002

Description: Standard D Shape Seat, Sc, Top Fix

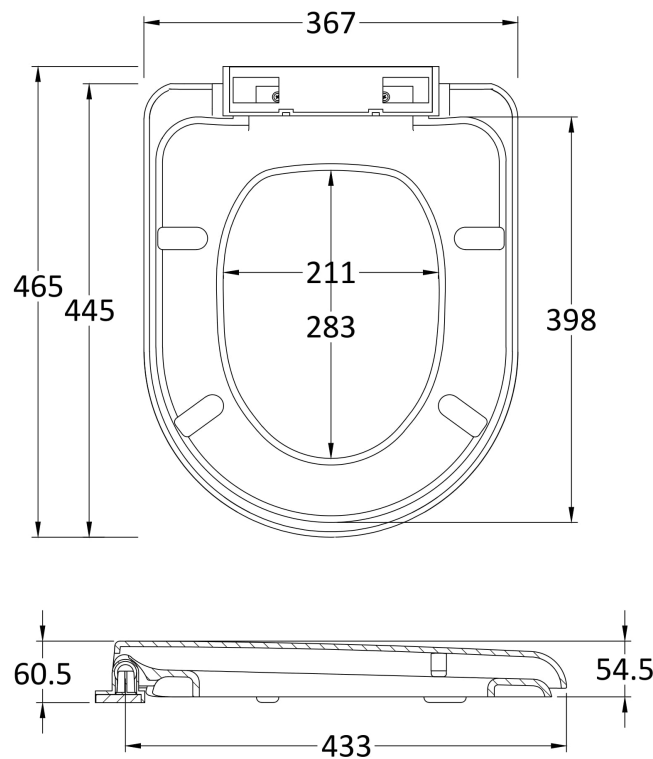

### Product Dimensions

Length (mm):	465
Width (mm):	367
Height (mm):	61
Nett Weight (kg):	1.84

### Packaging Dimensions

Length (mm):	465
Width (mm):	380
Height (mm):	55
Gross Weight (kg):	2.02

### Packaging Data

Box Colour:	White Cardboard Box - Printed
Box Qty:	1
Label Size:	100 x 50
Label Colour:	Not Applicable
Label Qty:	

### Outer Box Dimensions (If Applicable)

Length (mm):	580
Width (mm):	490
Height (mm):	400
Gross Weight (kg):	22
Barcode:	5060272824853

### Product Details

Country of Origin:	China
Fitting Instruction:	No
CE & UKCA:	Not Applicable
Product Material:	Polypropylene
Seat Type:	D Shape
Seat Function:	Soft Close
Hinge Centres (Min):	127.5
Hinge Centres (Max):	171.5
Hinge Material:	Polypropylene
Colour/Finish:	White
Fixing Method:	Top Fix