

Concept 170cm x 85cm Idealform Square Shower Bath LH No Taphole

ILLUSTRATED

- E0512** Concept 170cm x 85cm Idealform Square shower bath with no tapholes, left hand
- B9929** Concept bath filler 2 hole dual control
- E0504** Concept 170cm Square shower bath front panel
- E3169** Unilux 70cm end panel
- E1486** Luxury bath pop-up waste and overflow
- E0508** Concept Square shower bath screen, clear glass and bright silver finish
- A5901** TMV thermostatic mixing valve, 22mm

OPTIONS

- A7051** Connect Air single lever 2 tap hole bath filler

ILLUSTRATED PRODUCT DETAILS







Weights

- E0512** 26.00 KG
- B9929** 2.64 KG
- E0504** 3.57 KG
- E3169** 2.58 KG
- E0508** 18.50 KG
- A5901** 0.60 KG

Materials

- E0512** Idealform
- B9929** Chrome Plated Brass
- E0504** High Impact Polystyrene
- E3169** High Impact Polystyrene
- E1486** Mixed Material
- E0508** Toughened Safety Glass
- A5901** Chrome Plated Metal

Finishes

- E0512**  White (01)
- B9929**  Chrome (AA)
- E0504**  White (01)
- E3169**  White (01)
- E1486**  Chrome (AA)
- E0508**  Bright Silver (EO)
- A5901**  Chrome (AA)

Capacity

- E0512** 225.0 litres (to overflow)

Flow rates

- B9929** 80 Litres per minute @ 3 bar pressure

Designer

Robin Levien, RDI

Standards

Constructed to EN 198:2008. EN 14516

Special Notes

Consideration should be given to safe hot water delivery and the use of an appropriate temperature reduction device, see A5901AA or Part G for guidance. One taphole fittings require offsetting from the overflow. Check positioning and compatibility before specifying. Dedicated front panel and bath screen are unhandled.

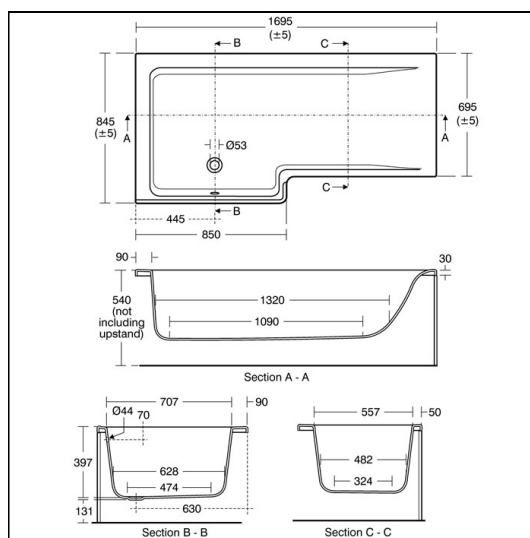

ACCREDITATIONS

B9929(AA)

Unified Water Label  **80.00** Litres Per Minute

E0512(01)

Unified Water Label  **225.0** Litres

A7051(AA)

Unified Water Label  **26.00** Litres Per Minute