

Concept 170cm x 70cm Idealform Spacemaker Shower Bath LH No Taphole

ILLUSTRATED

- E0499** Concept 170cm x 70cm Idealform Spacemaker shower bath with no tapholes, left hand
- B9929** Concept bath filler 2 hole dual control
- E0501** Concept 170cm Spacemaker shower bath front panel
- E3169** Unilux 70cm end panel
- E1486** Luxury bath pop-up waste and overflow
- A5901** TMV thermostatic mixing valve, 22mm

OPTIONS

- A7051** Connect Air single lever 2 tap hole bath filler

ILLUSTRATED PRODUCT DETAILS







Weights

- E0499** 24.15 KG
- B9929** 2.64 KG
- E0501** 3.50 KG
- E3169** 2.58 KG
- A5901** 0.60 KG

Materials

- E0499** Idealform
- B9929** Chrome Plated Brass
- E0501** High Impact Polystyrene
- E3169** High Impact Polystyrene
- E1486** Mixed Material
- A5901** Chrome Plated Metal

Finishes

- E0499**  White (01)
- B9929**  Chrome (AA)
- E0501**  White (01)
- E3169**  White (01)
- E1486**  Chrome (AA)
- A5901**  Chrome (AA)

Capacity

- E0499** 164.0 litres (to overflow)

Flow rates

- B9929** 80 Litres per minute @ 3 bar pressure

Designer

Robin Levien, RDI

Standards

Constructed to EN 198:2008. EN 14516

Special Notes

Consideration should be given to safe hot water delivery and the use of an appropriate temperature reduction device, see A5901AA or part G for guidance. One taphole fittings require offsetting from the overflow. Check positioning and compatibility before specifying. Dedicated front panel is unhandled. Suitable for use with Connect bath screens.

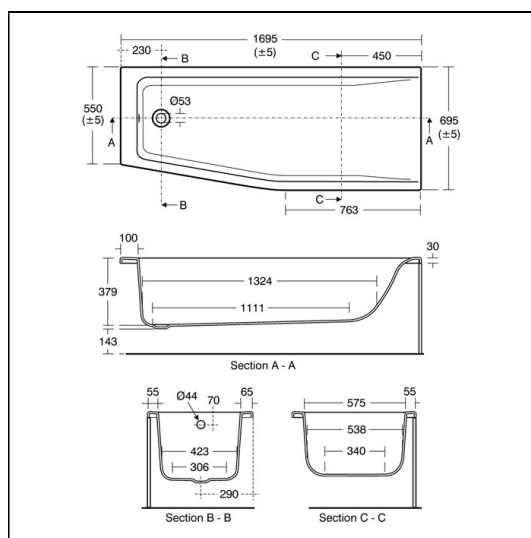

ACCREDITATIONS

B9929(AA)

Unified Water Label  **80.00** Litres Per Minute

E0499(01)

Unified Water Label  **164.0** Litres

A7051(AA)

Unified Water Label  **26.00** Litres Per Minute

FEATURES