

Tempo Cube Idealform Double-Ended 180cm x 80cm Bath No Handgrips No Tapholes

ILLUSTRATED

- E2584** Tempo Cube 180cm x 80cm Idealform double-ended bath, no handgrips no tapholes
- E2606** Tempo Cube 180cm bath front panel
- E2607** Tempo Cube 80cm end panel
- S8970** Trap 1½" plastic P with 75mm seal, multi-purpose outlet suitable for plastic and BS copper pipe
- E1486** Luxury bath pop-up waste and overflow
- A5901** TMV thermostatic mixing valve, 22mm

OPTIONS

- BD265** Ceraplan dual control bath shower mixer
- BD266** Ceraplan single lever bath filler
- BD267** Ceraplan single lever bath shower mixer
- S8830** Waste 1½" bath chain and overflow, plastic plug

ILLUSTRATED PRODUCT DETAILS







Weights

- E2584** 25.60 KG
- E2606** 5.00 KG
- E2607** 4.00 KG
- S8970** 1.00 KG
- A5901** 0.60 KG

Materials

- E2584** Idealform
- E2606** High Impact Polystyrene
- E2607** High Impact Polystyrene
- S8970** Plastic
- E1486** Mixed Material
- A5901** Chrome Plated Metal

Finishes

- E2584**  White (01)
- E2606**  White (01)
- E2607**  White (01)
- S8970**  Neutral / No Finish (67)
- E1486**  Chrome (AA)
- A5901**  Chrome (AA)

Capacity

- E2584** 248.0 litres (to overflow)

Designer

Robin Levien, RDI

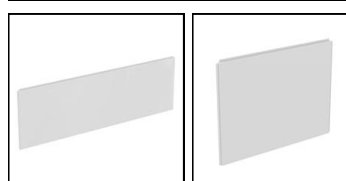
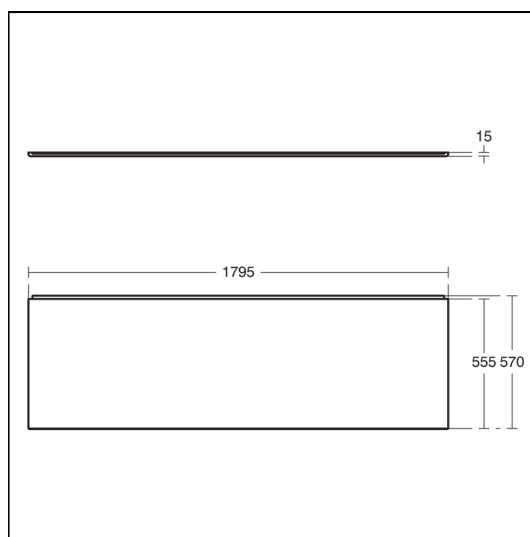

Standards

Constructed to EN 198:2008. EN 14516

Special Notes

Consideration should be given to safe hot water delivery and the use of an appropriate temperature reduction device, see A5901AA or Part G for guidance. One taphole fittings require offsetting from the overflow. Check positioning and compatibility before specifying.