

SUPERPLAN

- exclusive, elegant design
- made of KALDEWEI steel enamel
- flush-fitting recessed waste cover (only in combination with the KA 90 waste fittings)

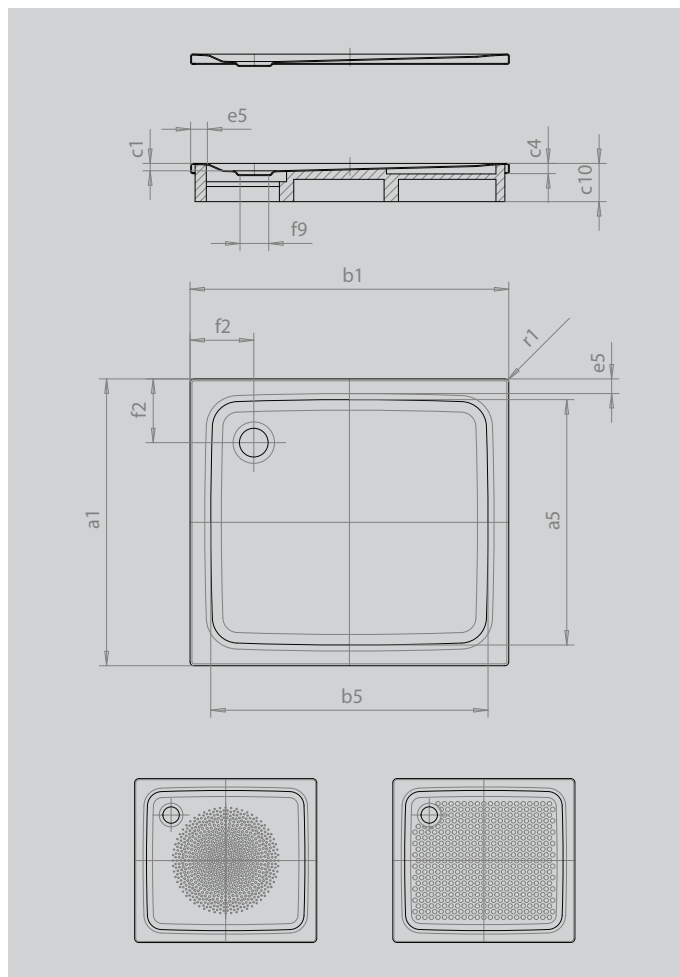

Similar illustration



SECURE⁺

Model		402
External length	a_1	750 mm
Internal length	a_5	640 mm
External width	b_1	1000 mm
Internal width	b_5	890 mm
Depth inside	c_1	25 mm
Height of rim	c_4	32 mm
Height with low-profile support	c_{16}	
Width of rim	e_{10}, e_5	50; 50 mm
Diameter of waste hole	f_9	Ø 90 mm
Distance bath edge to centre of waste hole	f_2, f_3	200; 200 mm
External radius	r_1	12 mm
Net weight		20 kg
Diameter of anti-slip		Ø 435 mm
Full anti-slip		524 x 781 mm
SECURE PLUS		full base

KALDEWEI