

Sales Code: HL502

Description: Thermostatic Heating Element (600W)

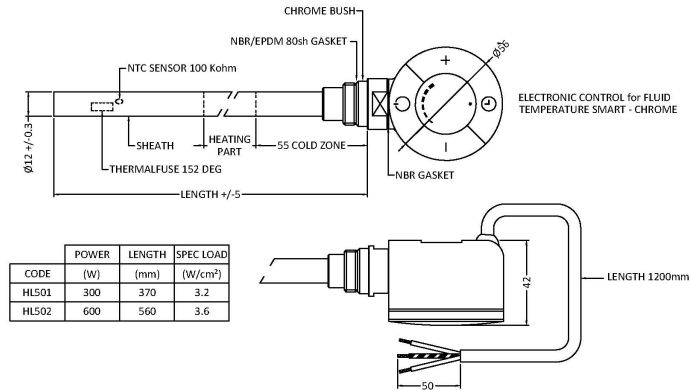

Product Dimensions

Height (mm):	45
Width (mm):	56
Depth (mm):	630
Length (mm):	
Nett Weight (kg):	0.6

Packaging Dimensions

Height (mm):	65
Width (mm):	105
Length (mm):	650
Gross Weight (kg):	0.6

Packaging Data

Box Colour:	Cardboard Tube
Box Qty:	1
Label Size:	100 x 50
Label Colour:	White Label
Label Qty:	1

Outer Box Dimensions (If Applicable)

Height (mm):	
Width (mm):	
Length (mm):	
Gross Weight (kg):	
Barcode:	5055275894026

Product Details

Country of Origin:	United Kingdom		
Fitting Instruction:	No		
Certification:	CE & UKCA: Yes	RoHS:	WEEE:
Colour/Finish:			
RAL No:			
Product Material:			

Heat Element Wattage:	600 W		
Heating Element Wattage Compatible:			
BTU Outputs:	30°C /	50°C /	60°C /
Thermal Outputs: (Watts)	30°C /	50°C /	60°C /

Pipe Centres - If Vertical:	
Pipe Centres - If Horizontal:	
Max Projection:	
Tube Diameter:	
Packaging Volume (L):	
Wall to Centre of Tappings:	
Floor to Centre of Tappings:	
Dual Fuel:	
IP Rating:	