

Sales Code: NBV005

Description: White Rectangular Ceramic Basin

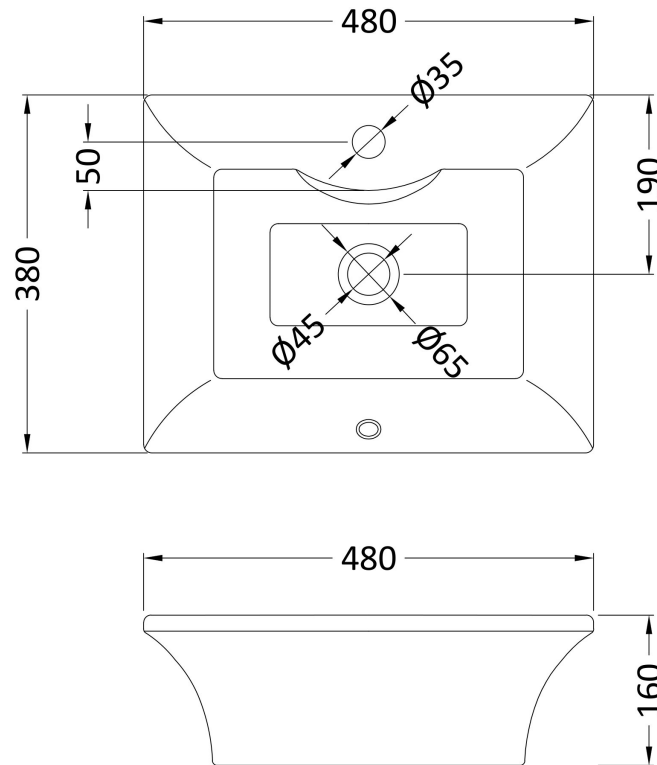

Product Dimensions

Height (mm):	160
Width (mm):	480
Depth (mm):	380
Nett Weight (kg):	10.8

Packaging Dimensions

Height (mm):	210
Width (mm):	515
Depth (mm):	430
Gross Weight (kg):	11

Packaging Data

Box Colour:	Brown Cardboard Box - Printed
Box Qty:	1
Label Size:	100 x 50
Label Colour:	White Label
Label Qty:	2

Outer Box Dimensions (If Applicable)

Height (mm):	
Width (mm):	
Depth (mm):	
Gross Weight (kg):	
Barcode:	5055146194446

Product Details

Country of Origin:	China
Fitting Instruction:	No
Certification: CE & UKCA:	No
WRAS:	N/A
WRAS No:	N/A
Product Material:	Vitreous China
Fixing Supplied:	No

Pans/Bidets: Trap Style: Not Applicable Includes Seat: Not Applicable

Seats: Seat Type: Not Applicable Material: Not Applicable
Function: Not Applicable Hinge Type: Not Applicable
Hinge Material: Not Applicable

Cisterns: Operating Type: Not Applicable Fittings: Not Applicable
Lever Type: Not Applicable

Basins: Tap Hole: One Taphole Chain Stay Hole: No
Template: Not Required Waste Type Req: Unslotted
Overflow Inc: Yes Overflow Cover: Yes
Inner Bowl Depth (mm): 105mm