

Sales Code: FJ313

Description: Series 2 Bath Filler

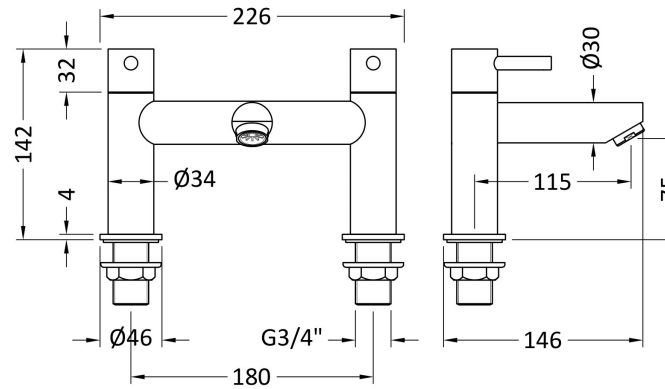

Product Dimensions

Height (mm):	142
Width (mm):	226
Depth (mm):	146
Length (mm):	
Nett Weight (kg):	1.6

Packaging Dimensions

Height (mm):	144
Width (mm):	230
Depth (mm):	144
Gross Weight (kg):	1.8

Packaging Data

Box Colour:	White Cardboard Box
Box Qty:	1
Label Size:	100 x 50
Label Colour:	White Label
Label Qty:	2

Outer Box Dimensions (If Applicable)

Height (mm):	400
Width (mm):	270
Depth (mm):	430
Length (mm):	
Gross Weight (kg):	6
Barcode:	5055146175230

Product Details

Country of Origin:	China
Fitting Instruction:	No
Product Material:	Brass
Control Type:	Manual
Waste Included:	Waste Not Included
Waste Type:	Not Applicable
WRAS Approval: No	Approval No: N/A
Valve/Cartridge Type:	1/4 Turn Ceramic Disc
Colour/Finish:	Chrome
Mount Type:	Deck
Operating Pressure (bar):	0.5

Flow Rates: (Litres Per Min)	0.1 bar: 8	0.5 bar: 24	1 bar: 37	2 bar: 43	3 bar: 0
Pipe Size:	22 mm (3/4" Bsp)				
Pipe Centres:	180 mm				