

CUSTOMER DATA SHEET - ENCLOSURES

SALES CODE: AQU769

DESCRIPTION: Pacific Off/Set Quad Enclosure 900X760



Pacific Offset Quadrant Enclosure

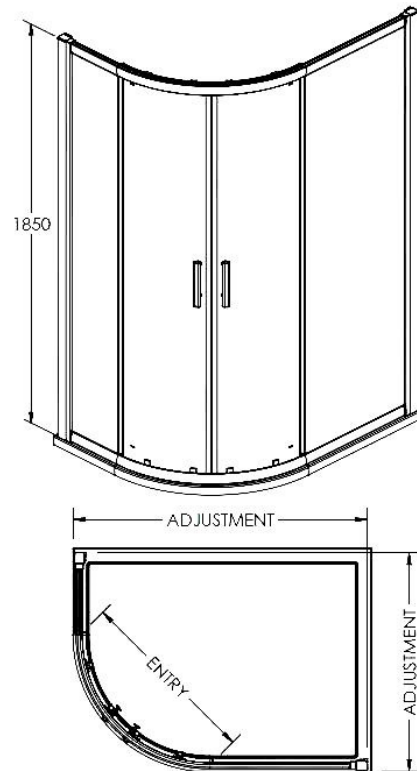

PRODUCT DIMENSIONS

Height (mm)	Width (mm)	Depth (mm)	Nett Wgt Kg
1850	740	880	41.1

PACKAGING DIMENSIONS

Height (mm)	Width (mm)	Length (mm)	Gross Wgt Kg
1910	430	150	41.1

PACKAGING DATA

Box Colour	Brown Cardboard Box - Printed		
Box Qty	1	Label Colour	Not Applicable
Label Size	100 x 50	Label Qty	0

OUTER BOX DIMENSIONS (If Applicable)

Height (mm)	Width (mm)	Depth (mm)	Length (mm)	Gross Wgt Kg
Barcode	5055146192541			

PRODUCT DETAILS

Country of Origin	China	CE Approval	Yes
Fitting Instruction	Yes		
Profile Material	Aluminium	Profile Finish	Polished Chrome
Adjustments (mm)	720mm - 740mm / 860mm - 880mm	Entry Width (mm)	420mm
Swing In Dim (mm)	N/A	Swing Out Dim (mm)	N/A
Radius (mm)	538 mm	Glass Thickness (mm)	6
Easy Fit	Yes	Easy Clean	No
Handle Style	Square T Shape Handle	Handle Material	Metal
Enclosure Design	Framed	Wheel Type	Chrome, Dual, Quick Release
Support Bar Inc'	Support Bar Not Included	Extras	None