

Compact Commercial

500mm HTM64 Horizontal Outlet Wash basin

APPLICATIONS: COMMERCIAL, EDUCATION, HEALTH CARE

RAK
CERAMICS



SPECIFICATION/CODE REFERENCE

Please use the reference codes shown below:

COM50BASSNHO

SIZE	500 x 390 x 205 mm
TAP HOLE	Intended for use with wall mounted taps
OVER FLOW	No over flow
WASTE OUTLET	Ø35mm back waste outlet
STANDARD	BS 3402
MATERIAL	Vitreous china
WEIGHT	16.00 kg
COLOURS	White
FIXING	The basin is fitted to the wall by using fixing kit FIXKITHO
WARRANTY	25 Years

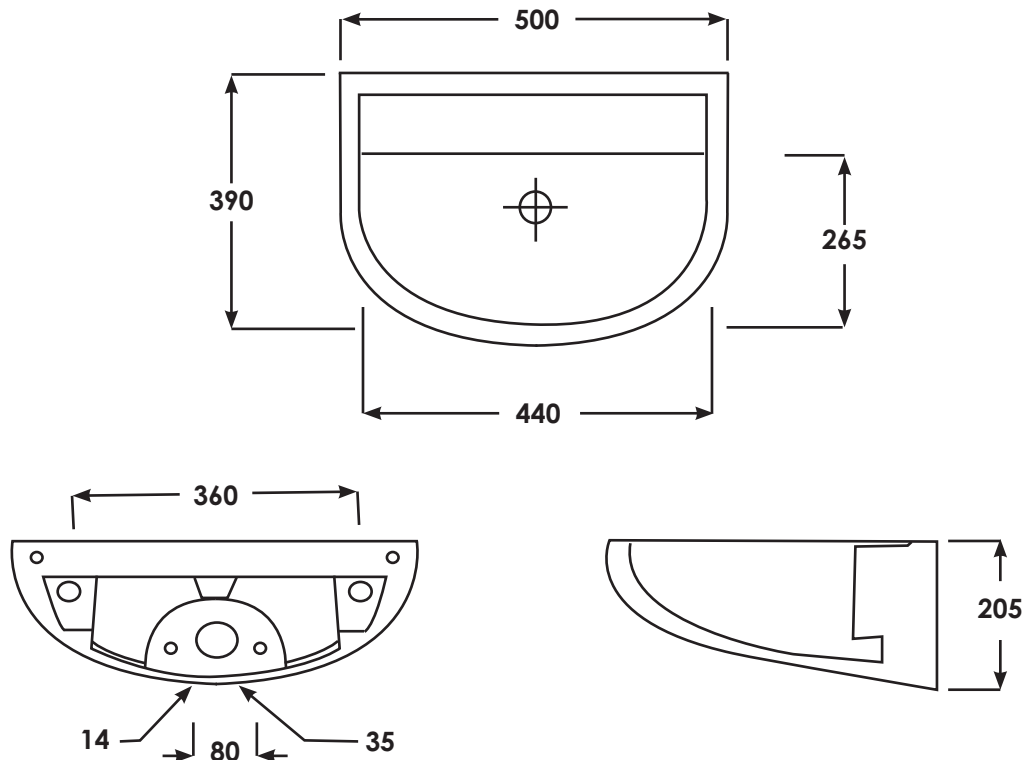

Dimensions: All measurements are in millimeters and are subject to normal manufacturing variations.

Note: Due to a continuing development programme to improve design and performance, the manufacturer reserves all rights to vary specifications without prior informations. Please note accessories are for photographic use only.

Tel: 01730 237850 Fax: 01730 263210. RAK Ceramics, Bradford House, Frenchmans Road, Petersfield, Hampshire GU32 3AW
Contact us at: info.uk@rakceramics.com / Visit us at: www.rakceramics.com 2017