

# RUSTIQUE FIRE CLAY CERAMIC INSET OR UNDERMOUNT SINK

CRUB3314WH/

**RANGEmaster**  
sinks & taps



**Size: 600 x 522 mm**

Fitted as either an inset or undermount sink, the Rustique kitchen sink collection provides a real focal point in the kitchen and contrasts excellently to all colours and features.

- Waste kit included
- 10 year warranty

Material	Fire clay Ceramic
Material Gauge	-
Material Finish Bowl	-
Material Finish Drainer	-
Drainer Position	
Overall Length (mm)	600
Overall Width (mm)	522
Main Bowl Length (mm)	360
Main Bowl Width (mm)	460
Main Bowl Depth (mm)	195
Second Bowl Length (mm)	162
Second Bowl Width (mm)	300
Second Bowl Depth (mm)	175
Tap hole Size (mm)	-
Waste Size (mm)	2 x 90
Waste Kit	Included with sink (2 x 90mm BSW & overflow kit)
Min. Base Unit (mm)	600
Cutout Size Length (mm)	525 / 575
Cutout Size Width (mm)	450 / 500
Warranty Sinks (years)	25
Product Code	CRUB3314WH/
Barcode	5015834049847

Date of download: July 18, 2023

AGA Rangemaster continuously seeks improvements in specification, design and production of products and thus, alterations take place periodically. Whilst every effort is made to produce up-to date resources, the information included here is intended as a guide. Always refer to the product's installation instructions when fitting, installation work should be completed a professional tradesman.

# RUSTIQUE FIRE CLAY CERAMIC INSET OR UNDERMOUNT SINK

CRUB3314WH/

## Technical Drawing

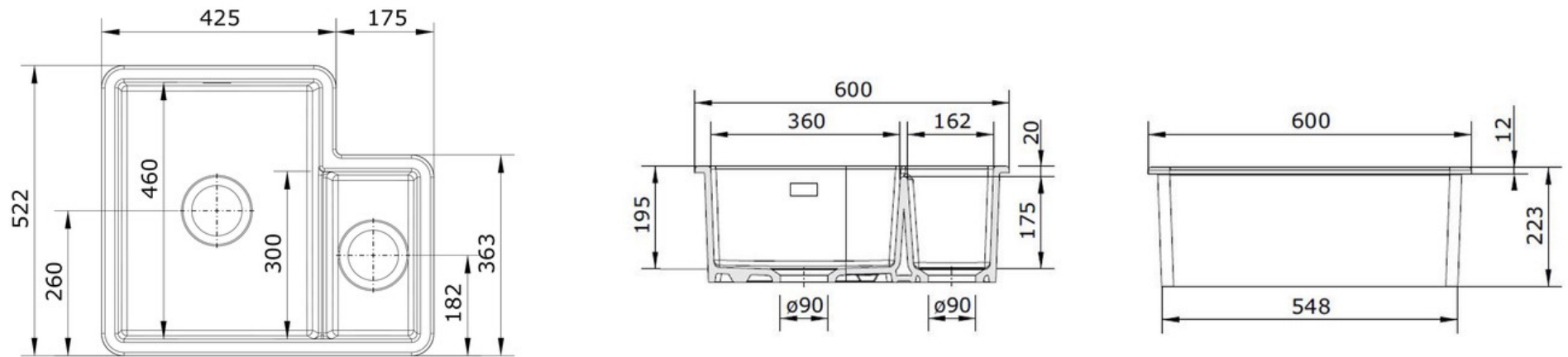

*NB: Due to manufacturing processes this sink may have a +/- 3mm tolerance on the measurements.*

Date of download: July 18, 2023

AGA Rangemaster continuously seeks improvements in specification, design and production of products and thus, alterations take place periodically. Whilst every effort is made to produce up-to date resources, the information included here is intended as a guide. Always refer to the product's installation instructions when fitting, installation work should be completed a professional tradesman.

# RUSTIQUE FIRE CLAY CERAMIC INSET OR UNDERMOUNT SINK

CRUB3314WH/

## Cut Out Template

Dimensions in mm. Not to scale.

### UNDERMOUNT INSTALLATION

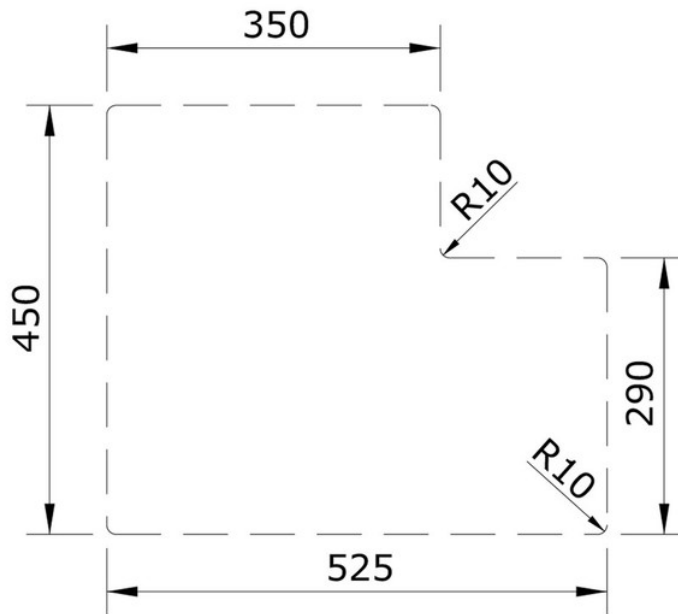

### INSET INSTALLATION

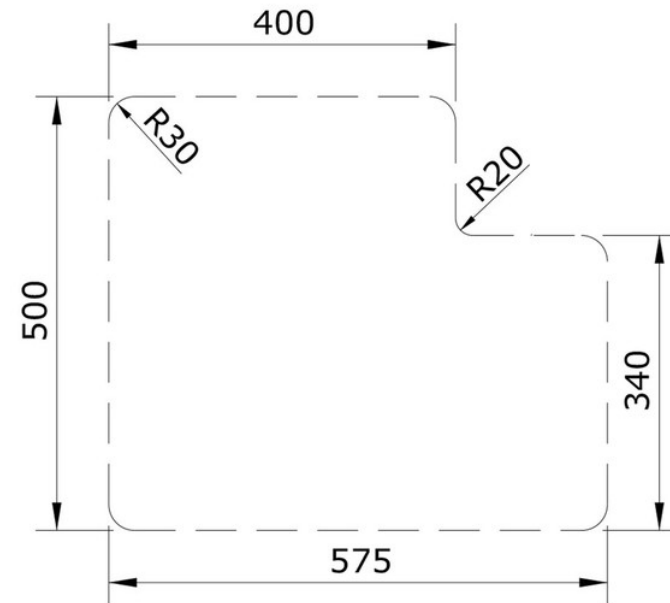

Date of download: July 18, 2023