

RUSTIQUE FIRE CLAY CERAMIC INSET OR UNDERMOUNT SINK

CRUB5340WH/

RANGEmaster
sinks & taps



Size: 598 x 462 mm

Fitted as either an inset or undermount sink, the Rustique kitchen sink collection provides a real focal point in the kitchen and contrasts excellently to all colours and features.

- Waste kit included
- 10 year warranty

Material	Fire clay Ceramic
Material Gauge	-
Material Finish Bowl	-
Material Finish Drainer	-
Drainer Position	
Overall Length (mm)	598
Overall Width (mm)	462
Main Bowl Length (mm)	536
Main Bowl Width (mm)	401
Main Bowl Depth (mm)	195
Second Bowl Length (mm)	-
Second Bowl Width (mm)	-
Second Bowl Depth (mm)	-
Tap hole Size (mm)	-
Waste Size (mm)	1 x 89
Waste Kit	Included with sink (1 x 89mm BSW & overflow kit)
Min. Base Unit (mm)	650
Cutout Size Length (mm)	532/ 575
Cutout Size Width (mm)	392 / 440
Warranty Sinks (years)	25
Product Code	CRUB5340WH/
Barcode	5015834050508

Date of download: July 19, 2023

AGA Rangemaster continuously seeks improvements in specification, design and production of products and thus, alterations take place periodically. Whilst every effort is made to produce up-to date resources, the information included here is intended as a guide. Always refer to the product's installation instructions when fitting, installation work should be completed a professional tradesman.

RUSTIQUE FIRE CLAY CERAMIC INSET OR UNDERMOUNT SINK

CRUB5340WH/

Technical Drawing

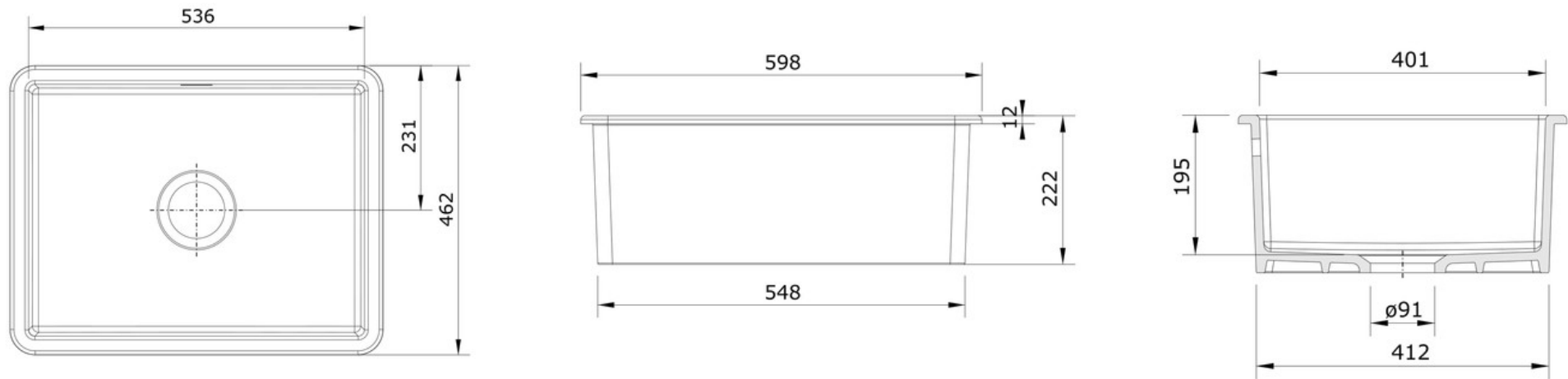

NB: Due to manufacturing processes this sink may have a +/- 3mm tolerance on the measurements.

Date of download: July 19, 2023

AGA Rangemaster continuously seeks improvements in specification, design and production of products and thus, alterations take place periodically. Whilst every effort is made to produce up-to date resources, the information included here is intended as a guide. Always refer to the product's installation instructions when fitting, installation work should be completed a professional tradesman.

RUSTIQUE FIRE CLAY CERAMIC INSET OR UNDERMOUNT SINK

CRUB5340WH/

Cut Out Template

Dimensions in mm. Not to scale.

UNDERMOUNT INSTALLATION

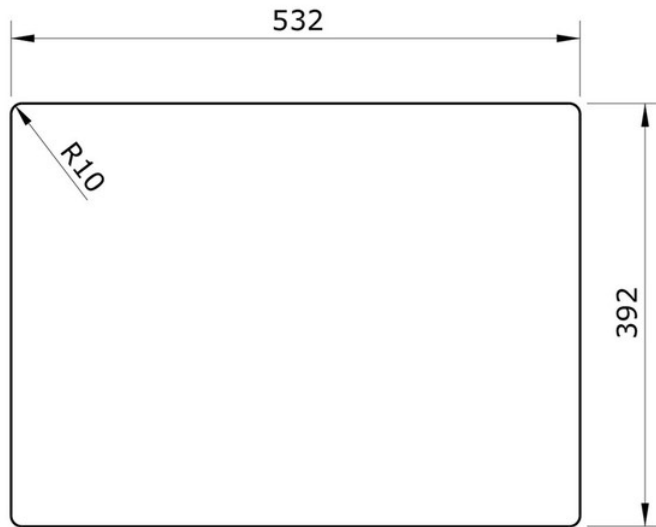

INSET INSTALLATION

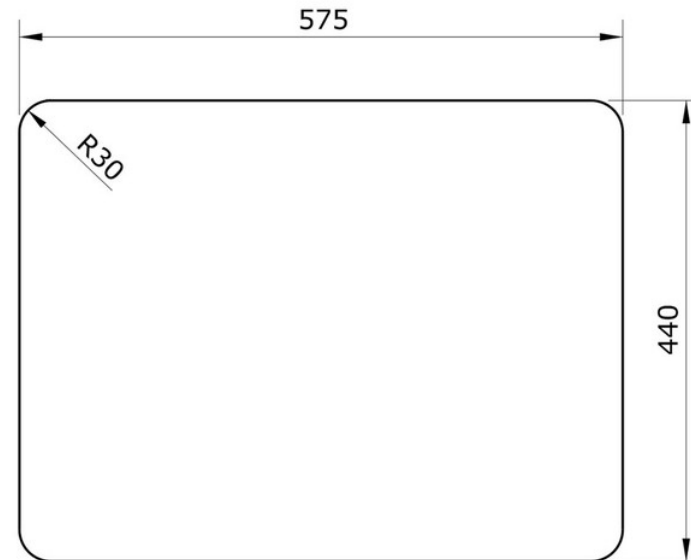

Date of download: July 19, 2023