

ATLANTIC CLASSIC 18/10 STAINLESS STEEL UNDERMOUNT SINK

UB3535/

RANGEmaster
sinks & taps



Size: 787 x 472 mm

The Classic undermount kitchen sink collection features an elegant curvature to the bowl design, creating a discreet sink solution suited to any kitchen scheme.

- 65mm radius corners
- Micro-sheen™ soft brushed finish
- Manufactured from 18/10 stainless steel
- Waste kit included
- 25 year warranty

Material	18/10 Stainless Steel
Material Gauge	0.9
Material Finish Bowl	Micro-Sheen™ Soft Brushed Finish
Material Finish Drainer	-
Drainer Position	
Overall Length (mm)	787
Overall Width (mm)	472
Main Bowl Length (mm)	350
Main Bowl Width (mm)	420
Main Bowl Depth (mm)	190
Second Bowl Length (mm)	350
Second Bowl Width (mm)	420
Second Bowl Depth (mm)	190
Tap hole Size (mm)	-
Waste Size (mm)	2 x 89
Waste Kit	Included with sink (2 x 89mm BSW & overflow kit)
Min. Base Unit (mm)	800
Cutout Size Length (mm)	755
Cutout Size Width (mm)	440
Warranty Sinks (years)	25
Product Code	UB3535/
Barcode	5015834036748

Date of download: July 19, 2023

AGA Rangemaster continuously seeks improvements in specification, design and production of products and thus, alterations take place periodically. Whilst every effort is made to produce up-to date resources, the information included here is intended as a guide. Always refer to the product's installation instructions when fitting, installation work should be completed a professional tradesman.

ATLANTIC CLASSIC 18/10 STAINLESS STEEL UNDERMOUNT SINK

UB3535/

Technical Drawing

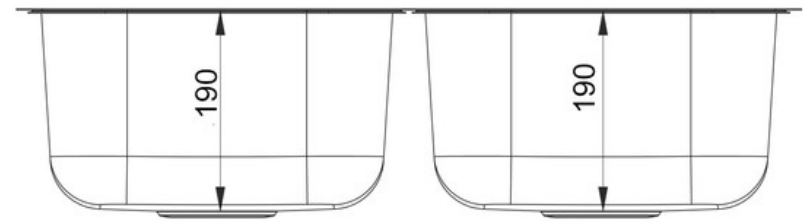
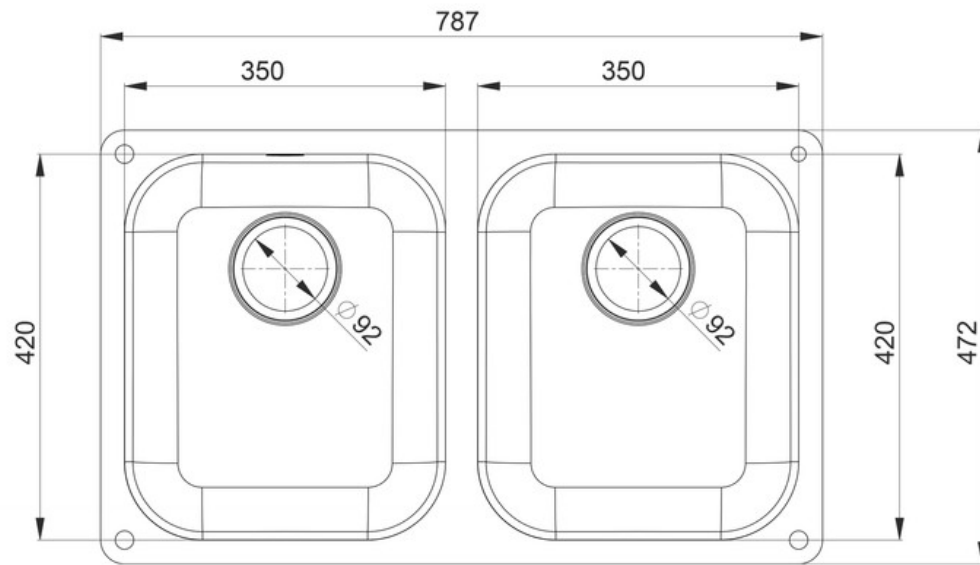

Date of download: July 19, 2023

AGA Rangemaster continuously seeks improvements in specification, design and production of products and thus, alterations take place periodically. Whilst every effort is made to produce up-to date resources, the information included here is intended as a guide. Always refer to the product's installation instructions when fitting, installation work should be completed a professional tradesman.

ATLANTIC CLASSIC 18/10 STAINLESS STEEL UNDERMOUNT SINK

UB3535/

Cut Out Template

Dimensions in mm. Not to scale.

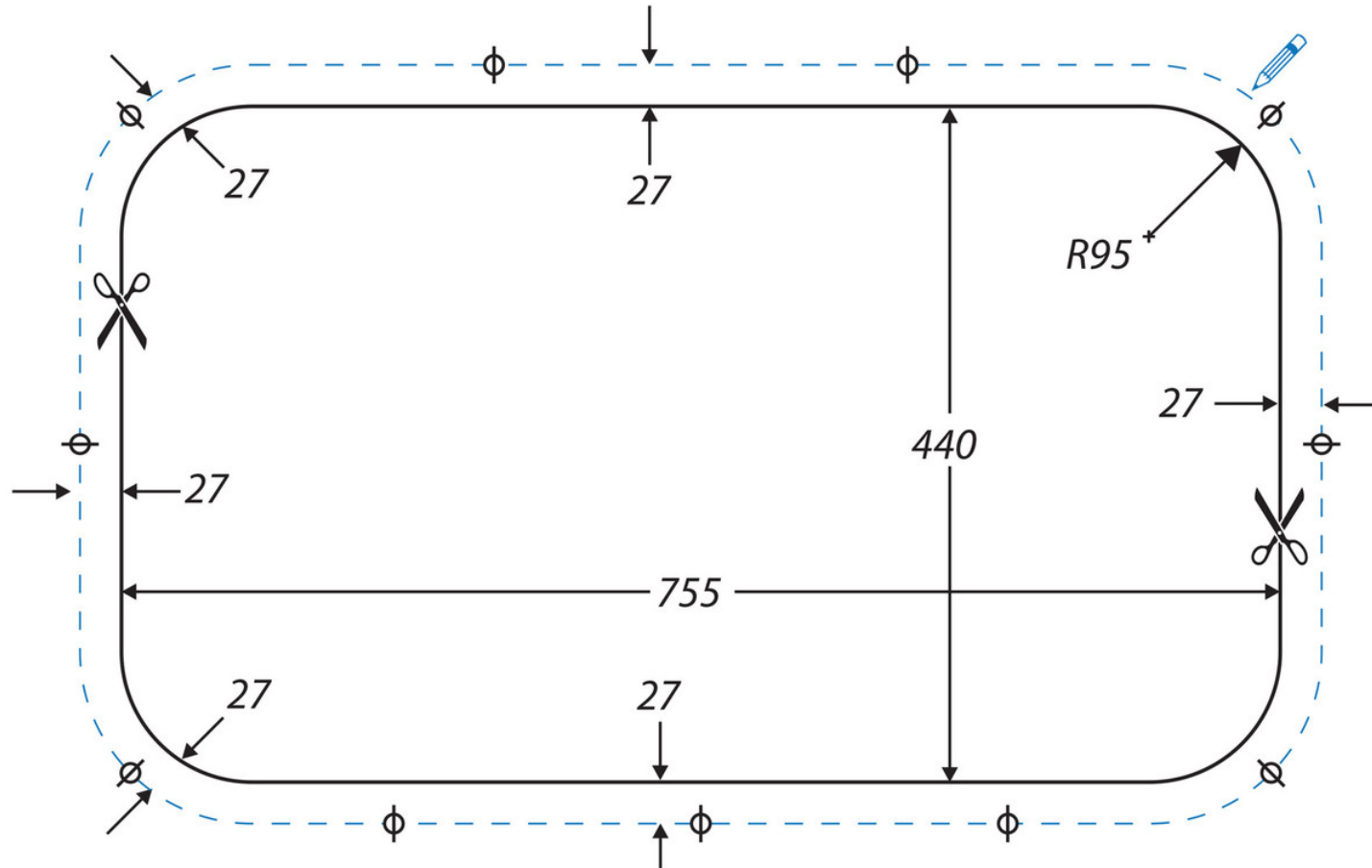

Date of download: July 19, 2023

AGA Rangemaster continuously seeks improvements in specification, design and production of products and thus, alterations take place periodically. Whilst every effort is made to produce up-to date resources, the information included here is intended as a guide. Always refer to the product's installation instructions when fitting, installation work should be completed a professional tradesman.