

# Caspian Skyline<sup>®</sup> E

Installation, commissioning  
and user manual

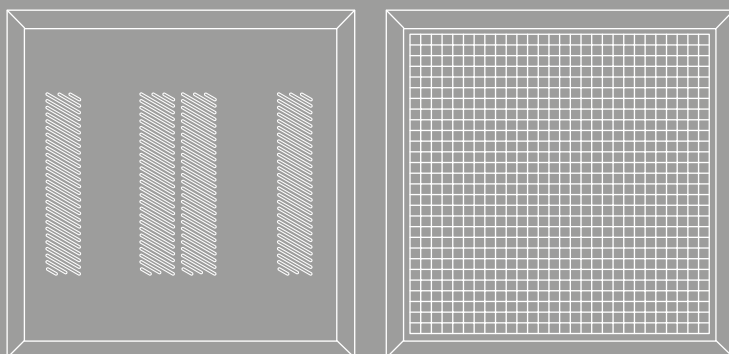

Skyline E 4kW - SLVT B

# Contents

Introduction	2
Declaration of conformity	2
Symbols used in this guide	3
Important safety and installation instructions	3/4
Application	4
Product Information	5
Installation	5
Electrical connections	8
Grille fixing	8
Wiring scheme	9
Fault finding	10
User Manual	
Important safety guidance	12
Introduction	13
Operation	13
Wall controller operation	14
Fault finding	16
Registering your product	17
Disposal	17
After sales and spares	17

# Introduction

The following items are included in the carton:

- Product complete with grille
- Grille fixing screws (9)
- Wireless wall controller

Note: This heater must be used with the SLVT B wireless controller (supplied) It will not work without it.

In the event of any items missing or visible damage, please contact us on +44 (0) 1245 324560.

Please leave this Installation and User Manual with the owner of the property.

# Declaration of conformity

EC Declaration of conformity  
We, Smith's Environmental Products Limited  
1-2 Blackall Industrial Estate  
South Woodham Ferrers  
Chelmsford  
Essex CM3 5UW  
Tel: 01245 324900 Fax: 01245 324422

Declare under sole responsibility that the products:

Product name:  
**Skyline E- 4kW**

Product range:  
**Caspian Skyline**

Listed above confirms with the following European Union directives:  
**Low Voltage Directive 2014/35/EU Safety Directive 98/37/EC**  
**EMC Directive 2014/30/EU Machinery (98/37/EC)**

Standards comply with the above directives.

Safety Directive Standards:  
**EN 60335-2-30:2009+A11:12 in conjunction with EN 60335-1:2012 + A11:14 + A13:17 +A14:19+ A2:19**  
**And deemed to comply**

This Declaration is made on behalf of Smith's Environmental Products Limited

# Symbols

This manual contains information and prescriptions marked by the following symbols:



Ignoring these safety provisions marked by the symbol "caution: hazard" may endanger the safety of people.



Ignoring these safety provisions marked by the symbol "caution: electricity" may endanger the safety of people, as well as the integrity of the equipment.



High temperature surface. Take utmost care to prevent people from getting in contact with the hot surfaces of the appliance.

# Important safety and installation instructions

Prior to installation, read these installation and operating instructions. The installation and operation should also be in accordance with national regulations and accepted codes of good practice.



This appliance is not intended for use by persons (including children) with reduced physical, sensory or mental capabilities, or lack of experience and knowledge, unless they have been given supervision or instruction concerning use of the appliance by a person responsible for their safety. Children should be supervised to ensure that they do not play with the appliance.

To guard against injury, basic safety precautions should be observed, including the following:

1. Read and follow all safety instructions and all the important notices on the appliance before installing, using and maintaining the appliance. Failure to do so may cause personal injury or damage to the appliance or installation.
2. Always disconnect electrical supply before putting on or taking off parts and whilst the equipment is being installed, maintained or handled. Never work with bare feet and/or with wet hands.
3. Carefully examine the appliance before and after installation. Do not operate the appliance if it has a damaged supply cord or enclosure, or if it is malfunctioning or it is dropped or damaged in any manner. Inspect the appliance periodically.
4. Improper use.

Do not use this appliance:

- In locations where special conditions prevail, such as the presence of a corrosive or explosive atmosphere (dust, vapour or gas) (EN60335-2-51);
- For other than intended use.

5. Installation.

The appliance must be mounted in a stable/ fixed position in a dry, well ventilated, frost-free, waterproof and protected place, with sufficient ventilation around it. Make sure that the appliance is securely and correctly installed before operating it and that there is enough room around it for maintenance operations, dismantling, checking for free inspection.

The maximum ambient temperature at which the appliance is to be used is 40°C (EN60335-2-51).

# Important safety and installation instructions

Prior to installation, read these installation and operating instructions. The installation and operation should also be in accordance with national regulations and accepted codes of good practice.



### 6. Electrical connection

**IMPORTANT:** Connection to the power supply must be effected by means of a fixed power cable which is fitted with a plug-type connection or a two pole isolating switch with a minimum contact opening of 3 mm.

Electrical connection must be carried out by a qualified electrician and in accordance with local regulations and both data on the name-plate and the appropriate diagram inside the terminal box cover.

Follow all safety standards.

### 7. All electrical work should be carried out in accordance with current IEEE regulations; we recommend the appliance is protected by a Residual Current Device (RCD or Ground-Fault Circuit-Interrupter) with a rated residual operating current not exceeding 30mA.

### 8. Prior to any modification being made to the equipment, it must be agreed with and authorised by the manufacturer. Original spare parts and accessories authorised by the manufacturer are integral part contributing to the safety of the equipment and of the machines. The use of non original components or accessories may endanger the safety and causes the termination of the warranty. Safe operation is only assured for the applications and conditions described in Application of this manual.

Non-observance of the safety instructions results in the loss of any claims to damages.

The indicated limit values are binding and cannot be exceeded for any reason whatsoever.

**KEEP THESE INSTRUCTIONS FOR FUTURE REFERENCE.**

## Application

This heater appliance is intended for use as a down draught air heater and can be mounted directly onto the ceiling or fitted into a 600 mm x 600 mm suspended ceiling tile frame. It is to be mounted with the underside between 2.5 and 3.0 metres from floor level. If exceeding 3 metres there will be a reduction in performance.

This heater appliance must not be used in bathrooms or similar high humidity areas.

Product Complies with LOT20.

Please note:

The guarantee may be invalidated if this product is not installed and used in accordance with this guide.

This heater will NOT function without the wall mounted wireless controller (supplied). The controller can control an unlimited number of heaters.

## Product performance

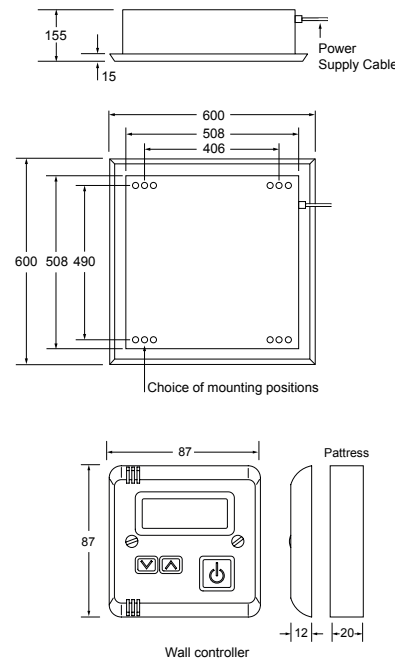

### Heat output

Heat Output (kW)	Power Consumption (kW)	Fused spur	Mains Cable (m)
4.0	4.1	20A	1.5

## Installation

### Preparation

- Ensure the mounting surface is capable of supporting this heater appliance and that the area can provide the installation clearances shown in diagram 1.

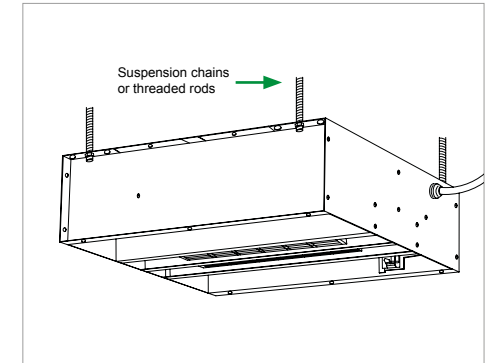

- If installing this heater appliance into a false or suspended ceiling, suitable suspension chains or rods (6 mm dia., threaded) will be required for attachment from the top of the heater appliance to the rigid or solid surface above the mounting area. When using this installation technique, it is recommended the four fixing points at the top corners of the heater appliance be used to minimise movement.

- An installation point for the heater appliance control must be selected, Controls as follows:  
Wireless wall controller

The selected area must be free from moisture and no higher than 2 metres from the floor.

- Remove the fascia and fixing screws. Store these in a safe place until required.
- Remove the screws retaining the side panel marked Electrical Connections and take out the panel. Store these until required.

## This heater appliance may be mounted in the following methods

### To mount the heater appliance direct to the ceiling

A surface mounting kit is available as an accessory. This kit provides a 135 mm skirt between the fascia and the ceiling.

1. Drill six holes in the ceiling to match 6 (3 per side) of the 14 holes available in diagram.

Note: The installation clearances given must be kept outside the broken lines shown. The lines represent the outer edges of the fascia panel.

2. Plug the drilled holes according to the ceiling type and construction material.
3. Secure the heater appliance to the ceiling using screws suitable for the purpose.
4. Refer to the section under Electrical Connections.
5. Replace and secure the panel marked Electrical Connections.
6. Replace the fascia and secure with all the original screws.

### To mount the heater appliance via suspension rods or chains

A ceiling tile spacer is available as an accessory. This kit allows the fascia to protrude 85 mm beneath the finished ceiling tile, matching the profile of the Skyline® CT18 hydronic model. A Surface mounting kit is also available which provides a complete four sided trim when fitted to a solid ceiling.

1. If the mounting area is to align with a false or suspended ceiling panel, then the holes must be centred to the panel.
2. Cut the suspension chains or rods to the required length for the installation. Secure to the mounting surface.
3. Secure the lower ends of the chains or rods to the top four corners of the heater appliance. Adjust the lengths of the chains or rods as necessary to ensure the heater appliance is true and level.
4. Refer to the section under Electrical Connections.
5. Replace and secure the panel marked Electrical Connections.

6. Replace the fascia and ensure it is secured with all the original screws.

## Unit Operation

Please note: This heater will NOT function without the wall mounted wireless controller (supplied) . The controller can control an unlimited number of heaters.

### Wireless Controller

The controller is primarily designed to minimise energy wastage and ensure the room is maintained at the comfort level set by the user. In the basic setting, the controller is a simple room thermostat in which the heater will run until the set temperature is reached. If the room temperatures falls the heater will switch on again until the set temperature is reached. The operating range is between 15°C and 35°C.

The controller also has a number of advanced features that, if required MUST be set during the installation process. Please discuss with your customer which features they require.

- **Temperature control for Comfort (COMF)**  
This can be set to limit the maximum temperature set by the user.
- **Temperature control for Setback (SETB)**  
This can be used for frost protection or situations where a minimum room temperature must be maintained. The setback temperature can be set between 0°C and 15°C.
- **Run-back Timer**  
This can be used to limit the run time of the heater from between 5 minutes and 2 hours. The Run-back Timer cannot be used in conjunction with Temperature control for Setback (SETB)

### Choosing a position in a room

The SLVT B controller should be fixed to the wall. Avoid areas with draught or direct sun. Do not position the controller above or close to the heaters or other heat sources. Damp areas or areas where SLVT B can be mechanically damaged should also be avoided. Avoid installing the controller in areas where there are metal objects between the heater and the controller. This will reduce the RF range. The RF range in ideal conditions can be up to 20m however this can be reduced when the signal is passing through the walls or other objects. The range can be also affected where the controller is mounted close

to power cables, motors or equipment producing strong electromagnetic field. If the temperature control feature is used it is necessary to use one controller for each room or zone.

### Pairing controller with heaters

In order to pair your appliance with the controller:



1. On the back of the controller, you will see the battery compartment. Pull and remove the battery tag. Look at the front display. If the batteries are good, the front battery display will show the temperature.



2. Turn the power to the appliance ON, and within **20 seconds** press and hold, the ON button on the controller until the display shows "PAIR"



3. After the pairing is finished, the display will show "TEST". If the pairing was successful, the appliance should function (This can take up to 5 seconds after pairing)

If process fail repeat all the steps again



4. Press the ON button to exit pairing

# Electrical Connection

## Heat Emitter

Connect the mains electrical supply cable (3 core, stranded 2.5mm<sup>2</sup>) via a switched fused isolator, fused at 20A to the heating appliance.

Do not energise the supply until the panels described have been returned and secured.

The electrical supply to this product should be via 2.5mm<sup>2</sup> stranded 3 core cable via a switch fused isolator fused at 20Amps.

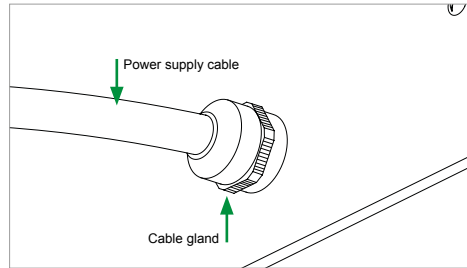

1. Locate the cable gland on the products chassis and loosen the clamping nut
2. Insert the supply cable into the cable gland
3. Feed the supply cable into the unit

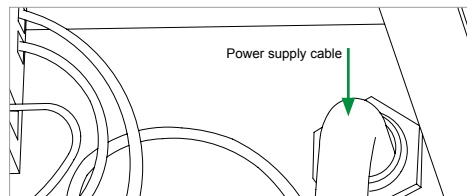

4. With the supply cable inside the cable route the cable to the terminal block
5. Insert the cable into the relevant connections on the terminal block

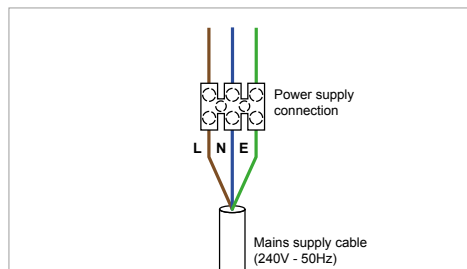

6. With the electrical connections made ensure that the mains cable does not obstruct any moving parts of the fan

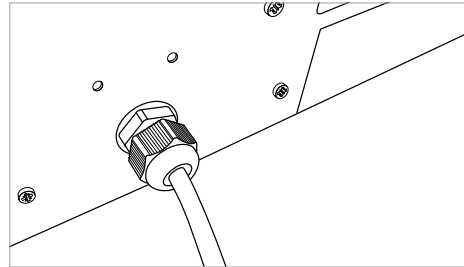

7. Tighten the clamping nut on the cable gland, once again ensure that wiring is not obstructing moving parts inside the product

## CT4E Grille fixing

- Align grille panel to heater unit and secure in position with all 9 screws provided.
- Ensure the grille panel is flat and free from distortions.

**Do not disturb the inner components of the heater unit**

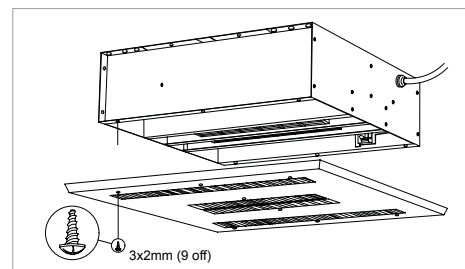
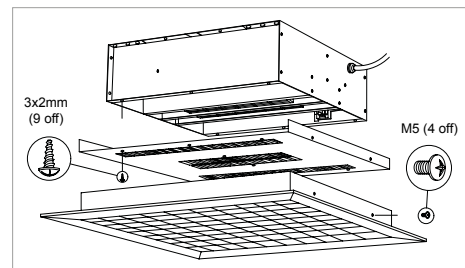

# Wiring scheme

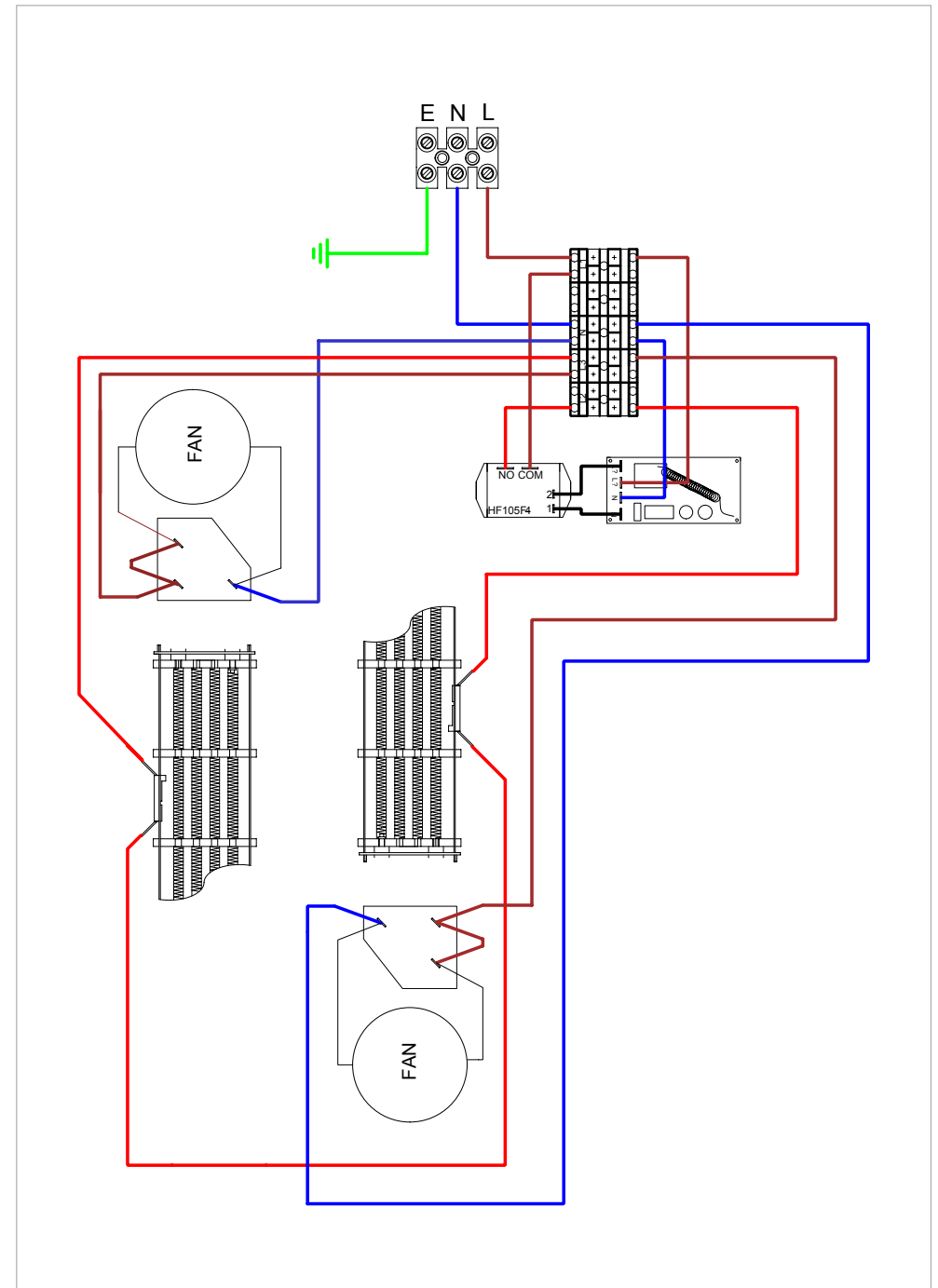

## Fault finding

In the event of any difficulty, please contact us on +44 (0) 1245 324560.

Fault	Checking/Solution
Fan does not run/no heat output	Check the power supply is switched ON Check fuse in fused spur Check the fan is switched on Check the battery in the controller and replace if necessary Check the wireless controller thermostat is calling for heat Check the wireless controller is paired to the heater
If the overheat protection has activated, manual reset as follows:	1. Switch the power supply OFF at the fused spur 2. Wait 5 minutes for the overheat cut-out switch to reset 3. Switch the power supply on

### Wireless Controller Self Diagnostic

The controller is equipped with a self diagnostic software that will check functionality of all main components. If there is a fault with any part of the controller or controller is operating outside of the temperature limits, the display will show 'Err' on the display. If this happens, controller will not function in order to protect itself and the heaters.

# Caspian Skyline® E

## User manual

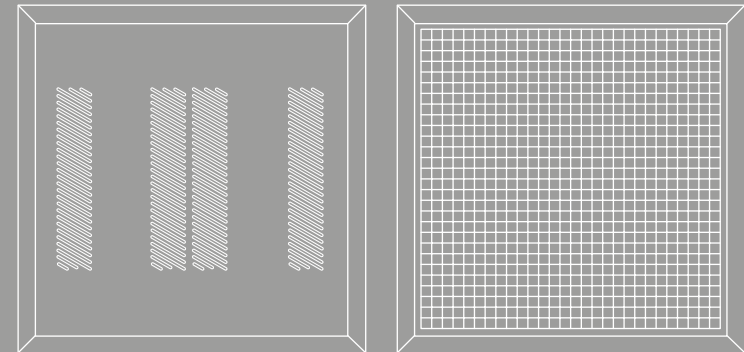

Skyline E 4kW - SLVT B

# Important safety and installation instructions

Please read this user manual before operating this appliance. The operation should also be in accordance with national regulations and accepted codes of good practice.



This appliance is not intended for use by persons (including children) with reduced physical, sensory or mental capabilities, or lack of experience and knowledge, unless they have been given supervision or instruction concerning use of the appliance by a person responsible for their safety. Children should be supervised to ensure that they do not play with the appliance.

To guard against injury, basic safety precautions should be observed, including the following:

1. Read and follow all safety instructions and all the important notices on the appliance before installing, using and maintaining the appliance. Failure to do so may cause personal injury or damage to the appliance or installation.
2. Always disconnect electrical supply before putting on or taking off parts and whilst the equipment is being installed, maintained or handled. Never work with bare feet and/or with wet hands.
3. Carefully examine the appliance before and after installation. Do not operate the appliance if it has a damaged supply cord or enclosure, or if it is malfunctioning or it is dropped or damaged in any manner. Inspect the appliance periodically.



#### 4. Improper use.

Do not use this appliance:

- In locations where special conditions prevail, such as the presence of a corrosive or explosive atmosphere (dust, vapour or gas) (EN60335-2-51);
  - For other than intended use.
5. Installation.

The appliance must be mounted in a stable/fixed position in a dry, well ventilated, frost-free, waterproof and protected place, with sufficient ventilation around it. Make sure that the appliance is securely and correctly installed before operating it and that there is enough room around it for maintenance operations, dismantling, checking for free inspection.



The maximum ambient temperature at which the appliance is to be used is 40°C (EN60335-2-51).

### Warnings (Wireless Controller)

- Do NOT handle the appliance with wet hands.
- Do NOT use the appliance in workshops or rooms where excessive dust is generated or present.
- Ensure that nothing is pushed into any aperture of this controller.
- Do NOT cover or restrict any aperture Do NOT use the appliance if damaged.
- Do NOT leave the appliance unattended where young children are present.
- Operating temperature range -10 to +40°C.

# How it works

Cooler air is drawn in by the fan and heated as it passes through the heating element before being discharged gently back into the room. This not only gives a more even temperature spread, but will heat up a room quicker than a traditional panel radiator.

The controller has a number of advanced features that, if required MUST be set during the installation process. Please discuss with your customer which features they require. The dip switches will need to be set prior to attaching the thermostat to the back box.

- **Temperature control for Comfort (COMF)**  
This can be set to limit the maximum temperature set by the user.
- **Temperature control for Setback (SETB)**  
This can be used for frost protection or situations where a minimum room temperature must be maintained. The setback temperature can be set between 0°C and 15°C.
- **Run-back Timer**  
This can be used to limit the run time of the heater from between 5 minutes and 2 hours. The Run-back Timer cannot be used in conjunction with Temperature control for Setback (SETB).

# How to operate

1. Before switching the heater on, please ensure the fascia grille is free from obstruction.
2. Ensure your fused spur is switched ON.
3. Ensure the controller is paired with the heater (see page 7).
4. Set the wireless thermostat to the desired temperature.
5. Providing the thermostat set point is set to a higher temperature of that in the room the heater will turn on.

For your safety this heater is fitted with an automatic overheat protection. If the heater stops, turn off the power at the fused spur, wait 5 minutes and switch the power back on.

### Wall Controller

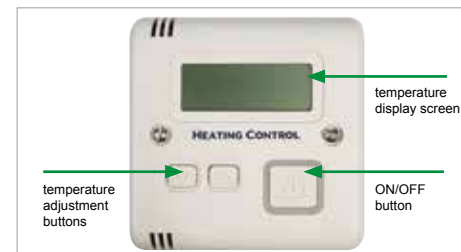

### Batteries in Wall Controller

It is recommended that the battery is changed every 12 months to protect potential damage by batteries leaking (batteries are supplied with the controller)

You do not need to re-pair after batteries have been changed (pairing is done by programming the chip memory)

# Wall Controller Operation

The controller is primarily designed to minimise energy wastage and ensure the room is maintained at the comfort level set by the user. In the basic setting, the controller is a simple room thermostat in which the heater will run until the set temperature is reached. If the room temperature falls the heater will switch on again until the set temperature is reached. The operating range is between 15°C and 35°C.

The controller also has a number of advanced features that, if required MUST be set during the installation process. Please discuss with your customer which features they require.

- **Temperature control for Comfort (COMF)**  
This can be set to limit the maximum temperature set by the user.
- **Temperature control for Setback (SETB)**  
This can be used for frost protection or situations where a minimum room temperature must be maintained. The setback temperature can be set between 0°C and 15°C.
- **Run-back Timer**  
This can be used to limit the run time of the heater from between 5 minutes and 2 hours. The Run-back Timer cannot be used in conjunction with the temperature control for setback (SETB)

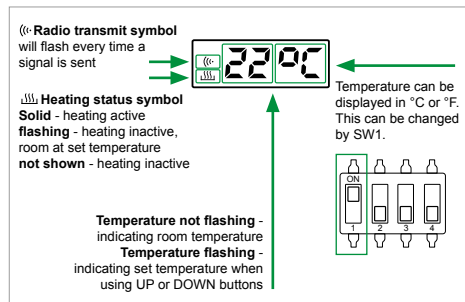
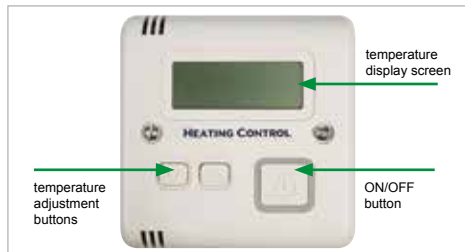

## Temperature Control Mode

Temperature control for Comfort period (COMF)  
Switch 1 controls the display screen. If it is set to 'ON' the temperature is displayed as Fahrenheit. If it is set to 'OFF' the temperature is displayed as Celsius.

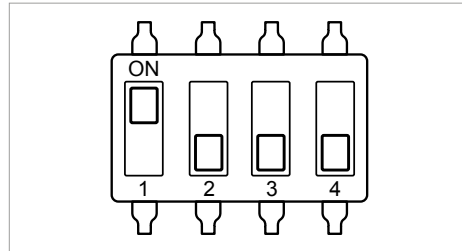

Prior to installation the maximum comfort temperature can be adjusted using the knob marked COMF located at the back of the controller as shown below. The range is 15°C to 35°C. The maximum comfort temperature limits the temperature that can be set by users after installation. After installation, the user can adjust the temperature using the UP and DOWN buttons, in the range from 15°C up to the maximum temperature set by the knob marked COMF.

After pressing the 'ON' button the heating will operate until the set room temperature is achieved, at this point the heating status symbol on the display will start flashing. When the room temperature drops the heating will become active again and the heating status symbol will change from flashing to steadily on.

The display screen will show the actual room temperature, except briefly when either of the two adjustment buttons are pressed, the new target room temperature is then temporarily displayed.

Note: After changing any settings, in order for the change to take place, the controller has to be set to heating inactive status.

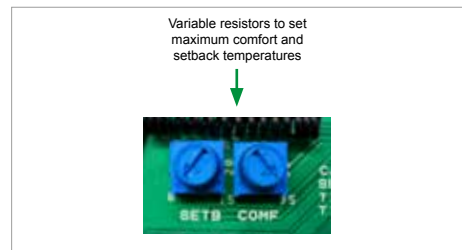

## Temperature control for Setback (SETB)

For this mode, the switches are set as shown below.

In this mode, the controller will set heating active when the room temperature drops below the set temperature. This feature can be used for frost protection or in situations where a minimum room temperature must be maintained. The setback temperature can be set using the knob marked SETB mounted on the back of the unit as shown bottom of page 14. This can be set from 0°C - 15°C.

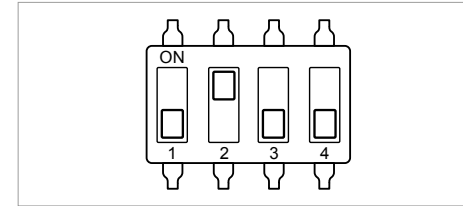

If the heating is active in the setback mode, the display will show the heating status symbol and the temperature will flash steadily.

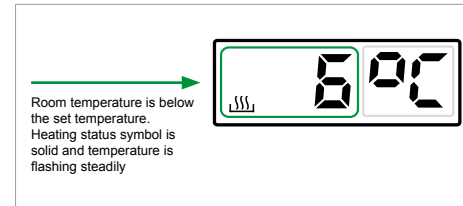

Temperature control for comfort and setback periods can be used individually or together. This can also be used in conjunction with the timer mode options.

## Run-back Timer

For timer mode, the switches are set as shown below.

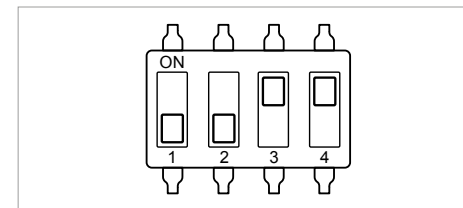

In timer mode, switch 3 or 4 must be in the 'ON' position. This mode allows for 3 different settings

- which will alter the time period for each segment.
- Switch 3 - Each time period represents 5 minutes
- Switch 4 - Each time period represents 15 minutes
- Switch 3 & 4 - Each time period represents 30 minutes

## Controller functionality in timer mode:

In timer mode, the controller acts as a 4 stage run-back timer. When the controller is in stand-by mode and button is pressed, the display will show 0h00. When pressed again the display will show time for the first stage of the run back timer in minutes and heating is activated. When pressed again the display will show time for the second stage and so on. Each stage is representing a time period that is selected when setting the switches.

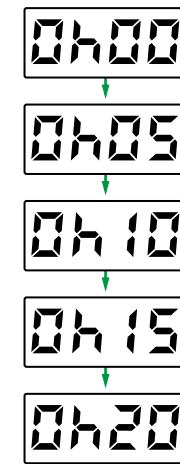

In the example, the only switch in the 'ON' position would be number 3. The button would be pressed four times to activate four 5-minute segments resulting in the heater staying on for 20 minutes. At the end of the last time period the controller is now in stand-by mode. If the 'ON' button is pressed the display will show remaining time. The remaining time can be increased at any time by pressing the 'ON' button.

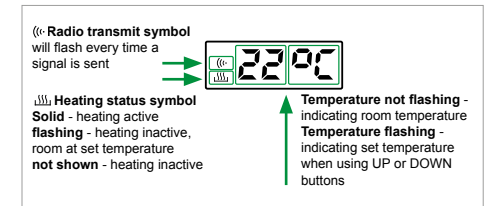

## Batteries

It is recommended that the battery is changed every 12 months to protect potential damage by batteries leaking (batteries are supplied with the controller)

You do not need to re-pair after batteries have been changed (pairing is done by programming the chip memory)



## Fault finding

This Space Saver is covered by a free 5-year parts and labour guarantee. Please refer to the Fault finding table below for advice. In the event of difficulty, please contact us on +44 (0) 1245 324560.

Fault	Checking/Solution
Fan does not run/no heat output	Check the power supply is switched ON Check fuse in fused spur Check the fan is switched on Check the battery in the controller and replace if necessary Check the wireless controller thermostat is calling for heat Check the wireless controller is paired to the heater
If the overheat protection has activated, manual reset as follows:	1. Switch the power supply OFF at the fused spur 2. Wait 5 minutes for the overheat cut-out switch to reset 3. Switch the power supply on

## Registering your product

Thank you for purchasing a Smith's product. It has been designed and manufactured to the highest quality standards to ensure it gives you efficient and trouble-free service for many years. To back up our commitment, included with your product is the following warranty:

### 5 years from date of purchase

This gives you the peace of mind that in the unlikely event of product failure, we will repair or replace the product completely free of charge providing the product has been installed, used and maintained in accordance with the instructions. Your statutory rights are not affected by this warranty.

It is important to register as soon as possible online at: [smithsep.co.uk/product-registration/](http://smithsep.co.uk/product-registration/). This will ensure you will receive prompt and efficient service if your product requires attention within the warranty period. If you do not register your product, you will be required to produce proof of purchase prior to receiving service.

For more details please visit our website: [SmithsEP.co.uk](http://SmithsEP.co.uk)

## Disposal

As part of the policy of continuous product improvement, Smith's Environmental Products LTD reserves the right to alter specification without prior notice.

Products with this symbol (crossed out wheellie bin) cannot be disposed as household waste. Old electrical and electronic equipment must be recycled at a facility capable of handling these products and their waste by-products. If you are purchasing replacement equipment your retailer may offer a 'take back' scheme, or will be able to give details of the nearest approved authorised treatment facility. Proper recycling and waste disposal will help conserve resources whilst preventing detrimental effects on our health and the environment.

WEEE Registered Code: WEE/ED0093VW



## After sales and spares

If you experience any problems with the use of your product, please contact our after-sales office +44 (0) 1245 324560.

For product information, customer services or sales support call us on +44 (0) 1245 324900

For the Republic of Ireland, contact MT Agencies on 01 864 3363

Sales: [sales@SmithsEP.co.uk](mailto:sales@SmithsEP.co.uk)  
 General information: [info@SmithsEP.co.uk](mailto:info@SmithsEP.co.uk)

Smith's Environmental Products Ltd  
 Blackall Industrial Estate, South Woodham Ferrers,  
 Chelmsford, Essex CM3 5UW

[SmithsEP.co.uk](http://SmithsEP.co.uk)

@SmithsEP\_UK

#ThinkSmiths

## Notes

---

---

---

---

---

---

---

---

---

---

---

---

---

---

---

---

---

---

---

---

---

---

---

---

---

---

---

---

---

## Notes

---

---

---

---

---

---

---

---

---

---

---

---

---

---

---

---

---

---

---

---

---

---

---

---

---

---

---

---

---



### Happy to help

Smith's Environmental Products Ltd is one of the leading manufacturers of heating and cooling products in the UK. We are committed to achieving the highest standards and our faith is supported by a free parts and labour guarantee with every product. Our customer service is second to none and we are happy to offer any help and guidance that you might need.

### Stockists

All products are available nationally from Builders' Merchants, Plumbers' Merchants, Heating Equipment Distributors and Kitchen Equipment Distributors. In the event of difficulty, please contact us or visit our website [SmithsEP.co.uk](http://SmithsEP.co.uk) for details of your nearest stockist.

### Information and advice

Full technical specifications and list prices is available to download from our website or in hard copy from our office. Also available on our website are price lists, individual product data sheets, installation & user guides, where to buy, who to contact and a media centre.

Alternatively contact our office 9.00am to 5.00pm Monday to Friday.

As part our commitment to continuous improvement Smith's Environmental Products may change the specifications of its products without prior notification or public announcement. All descriptions, illustrations, drawings and specifications in this publication present only general particulars and shall not form part of any contract. All dimensions are in mm unless otherwise stated.

**To view the full product information  
download the datasheet at:  
[www.SmithsEP.co.uk](http://www.SmithsEP.co.uk)**

For product information, customer services or sales support call us on **+44 (0) 1245 324900**

For the Republic of Ireland, contact MT Agencies on 01 864 3363

**Sales: [sales@SmithsEP.co.uk](mailto:sales@SmithsEP.co.uk)  
General information: [info@SmithsEP.co.uk](mailto:info@SmithsEP.co.uk)**

Smith's Environmental Products Ltd  
Blackall Industrial Estate, South Woodham Ferrers,  
Chelmsford, Essex CM3 5UW

**[SmithsEP.co.uk](http://SmithsEP.co.uk)**

**[@SmithsEP\\_UK](https://twitter.com/SmithsEP_UK)**

**[#ThinkSmiths](https://www.facebook.com/ThinkSmiths)**

Issue 006 | November 2022