

Trays

Installation Instructions

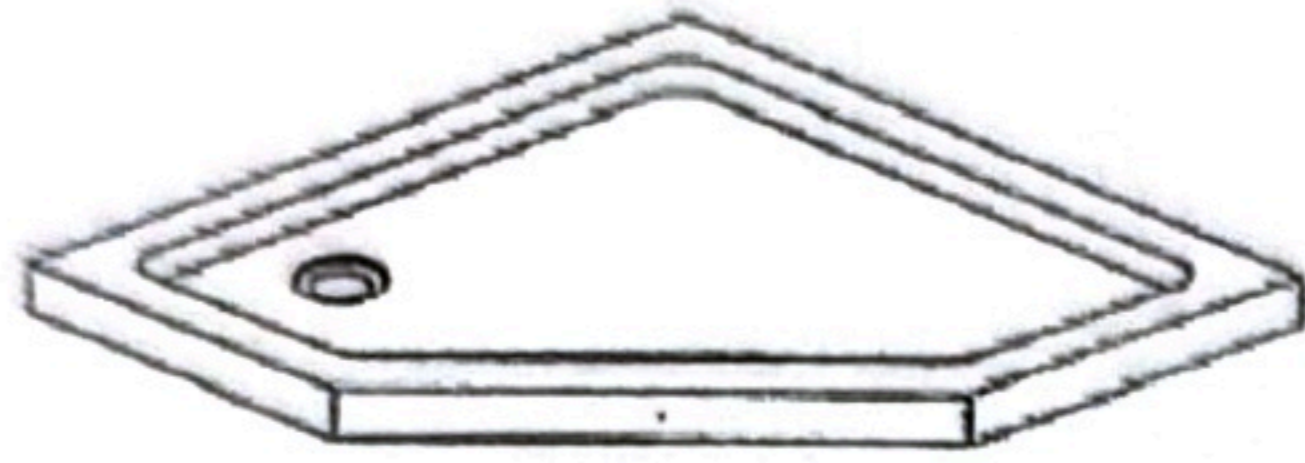

IMPORTANT - please read before installation

Before lifting, check the weight and get help if required.
Please note that this tray is not supplied with a waste.
Please check the tray size is correct before attempting to install.
Check the adjustment range of the enclosure before installation and be sure to factor this in to the installation of the shower tray and wall coverings.

Pre installation checks

The tray should be thoroughly checked for damage and faults before installation.
The tray should be levelled and tested for correct drainage before installation.
After installation, no claims will be accepted for issues which could have been picked up during the recommended pre installation checks.
Any issues must be reported to your place of purchase immediately.

For timber floors

Floor boards should be removed and replaced with a single sheet of marine plywood, with a minimum thickness of 18mm.
The plywood should be secured with screws and there should be no movement/flex in this. Noggins between joists may be required.
Waste pipework should be installed and tested for leakage before the next steps are carried out.
Mix a 2:1 mix of sand and cement, and apply a 30mm thick screed to the area where the tray is to be bedded.
Place the tray in position and level it accordingly.

For solid concrete floors

If the floor is uneven, then a levelling compound should be used before bedding the tray on sand and cement.
Waste pipework should be installed and tested for leakage before the next steps are carried out.
Mix a 2:1 mix of sand and cement, and apply a 30mm thick screed to the area where the tray is to be bedded.
Place the tray in position and level it accordingly.

Once the tray is installed, seal around the edge of the tray and allow to dry for 24 hours.
Sealant drying times may vary in cold damp conditions and will be extended where thicker beads of sealant are applied.
Allow sealant to dry completely before exposing to water.

After care / cleaning

The tray should be cleaned with warm soapy water and soft cloth or sponge on a regular basis.

1

Fixings & fittings supplied

Part	Quantity
	x 1

Tools required (not supplied)

spirit level		silicone sealant	
--------------	--	------------------	--

2

① ASSEMBLY INSTRUCTIONS

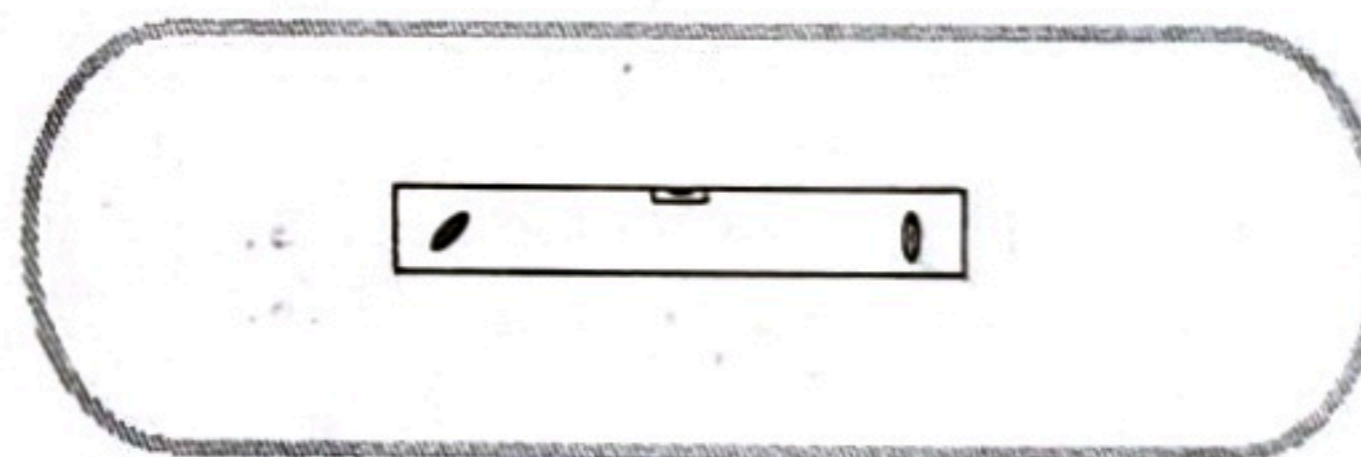

- Fit the waste to the tray.
- Ensure the location of the shower tray is level, dry and free of rubble.

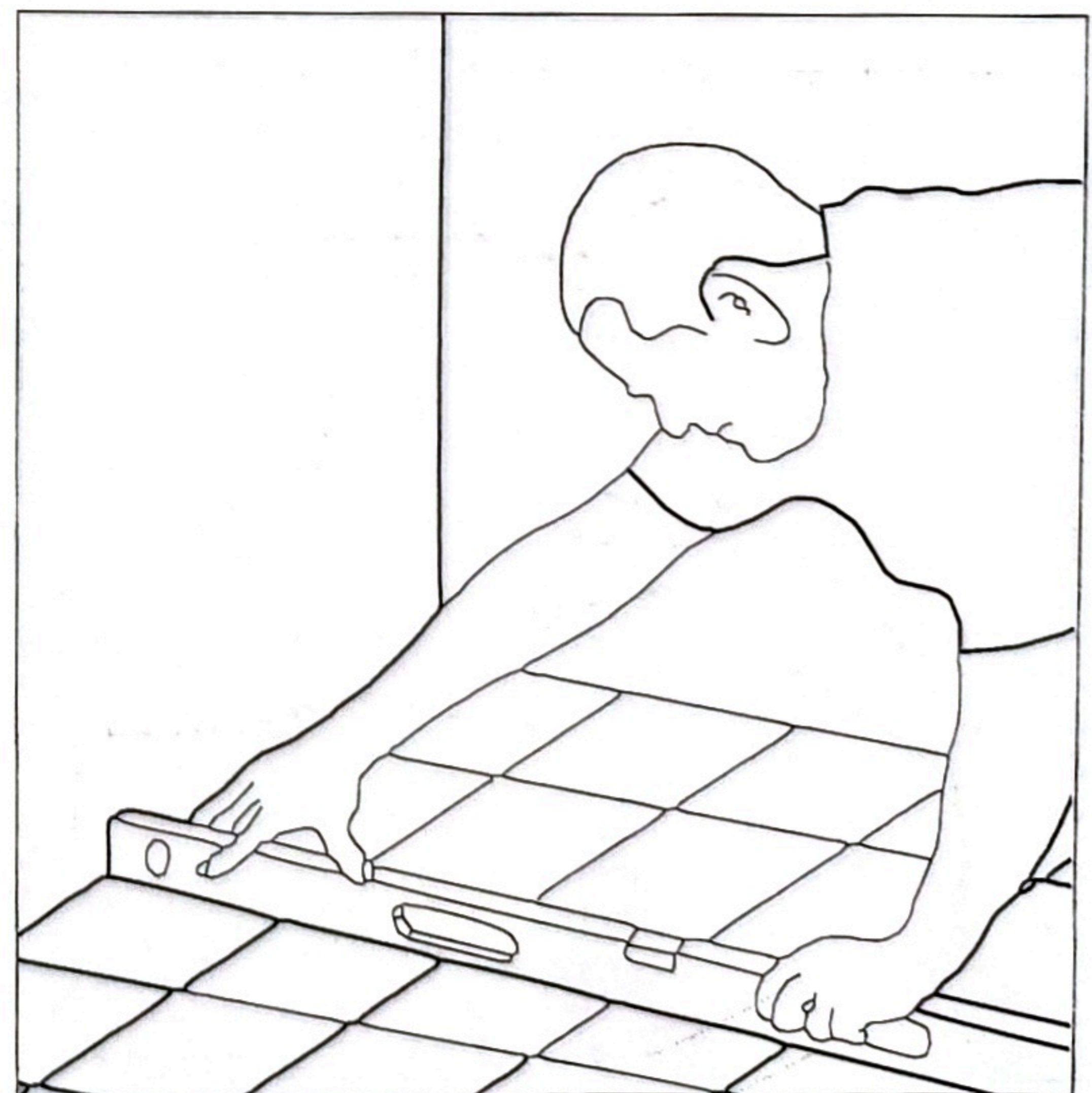

3

② ASSEMBLY INSTRUCTIONS

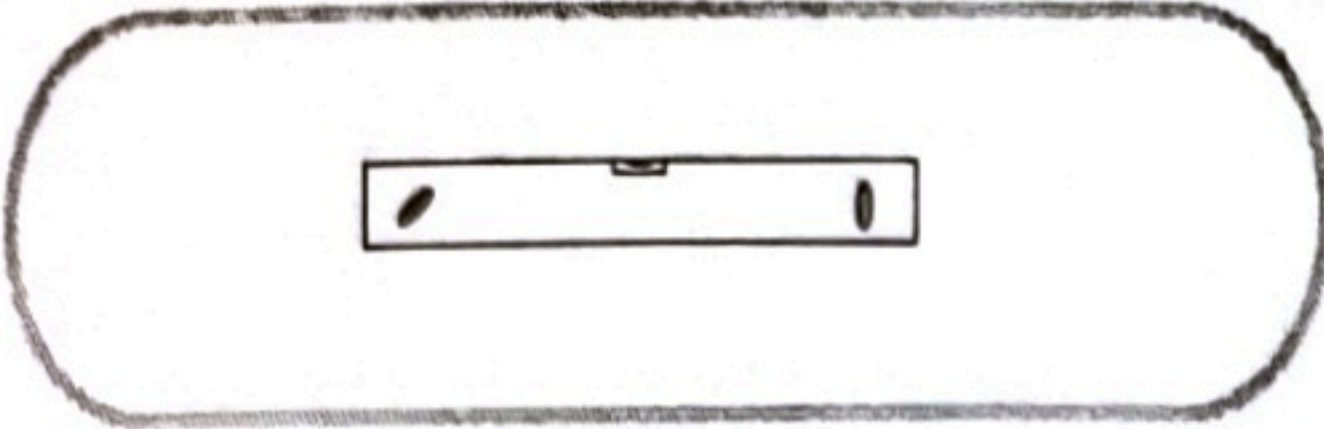

- Position the tray up to the walls and rebate into the plaster as required.
- Remove the tray from its position.

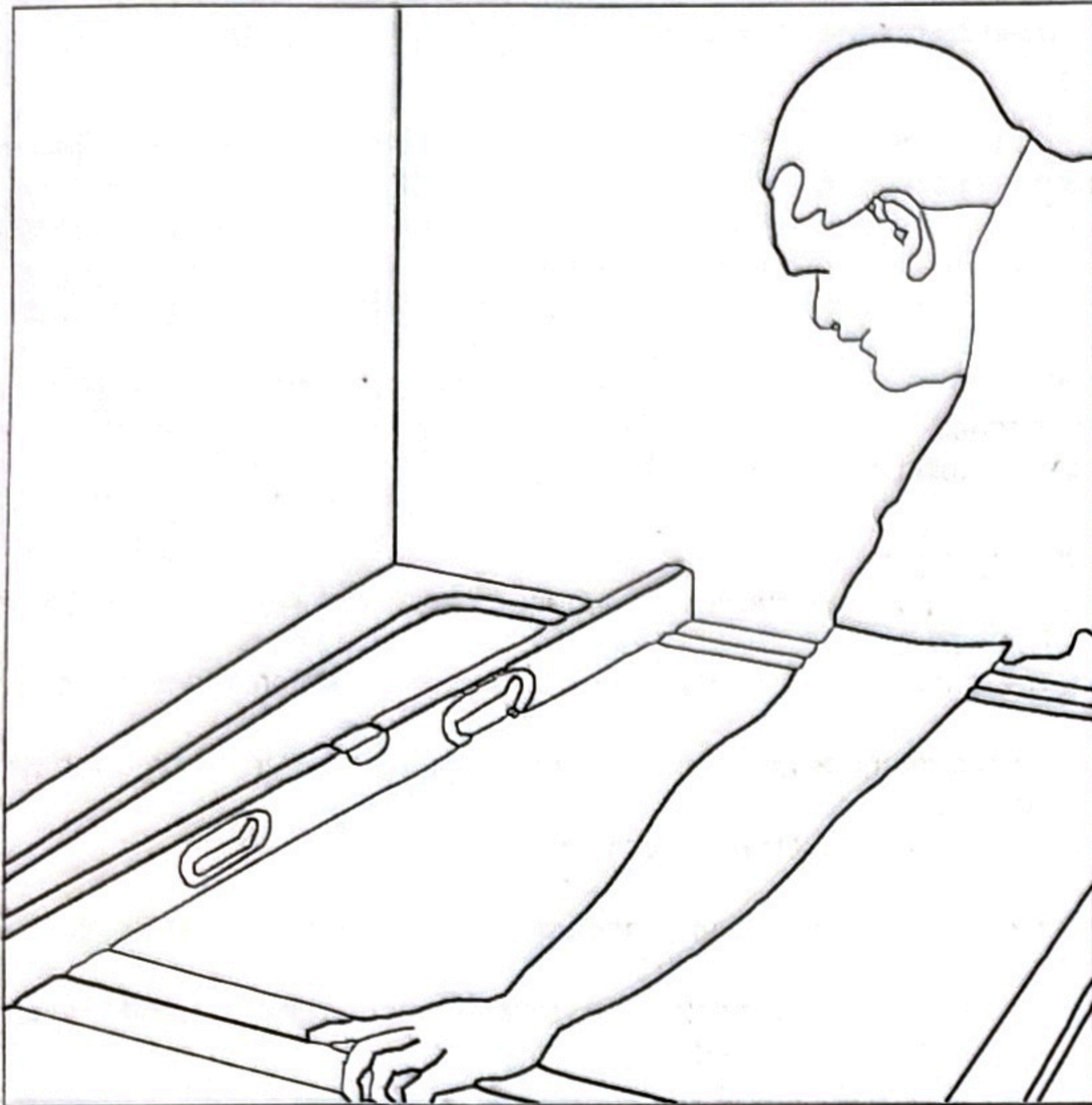

4

③ ASSEMBLY INSTRUCTIONS

- If installing your tray on a relatively level floor use a sand cement based adhesive to bed the tray. Shims or wedges can be used for low spots on uneven floors.
- If the floor is a rough but relatively level stone floor, it is recommended to use a suitable self leveling skim to correct this before proceeding with the installation.
- Make sure the siphone position has enough space and depth for the siphone body.

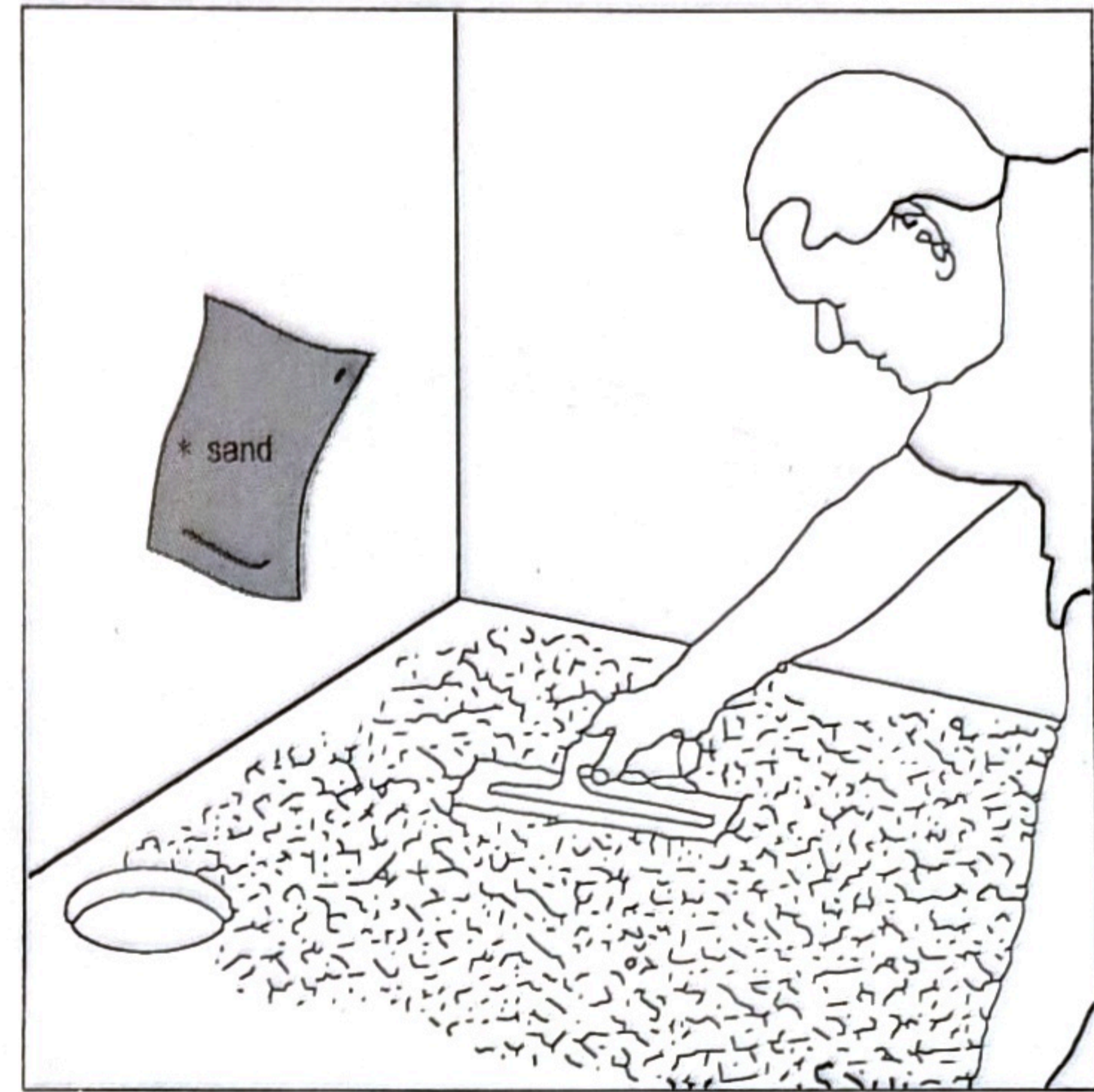

5

④ ASSEMBLY INSTRUCTIONS

- Put the tray back.
- Connect the waste pipe and check for leakage.
- Showering water on the tray to check the water flowing and the left pooling status. Adjust the tray bottom with shims or wedges if necessary to have satisfying status.



6

⑤ ASSEMBLY INSTRUCTIONS

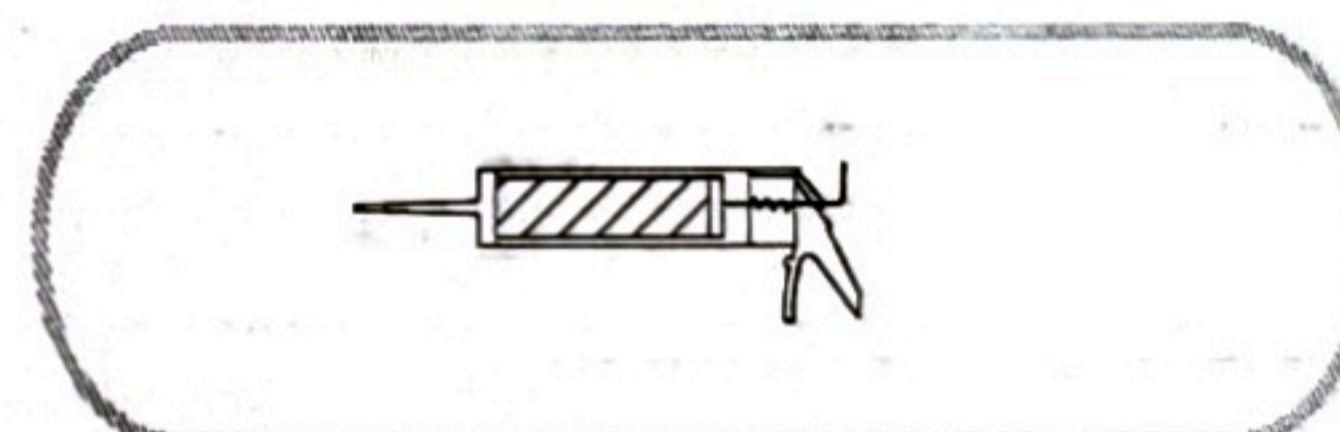

- Seal the joint between the shower tray and adjacent wall with silicone sealant.

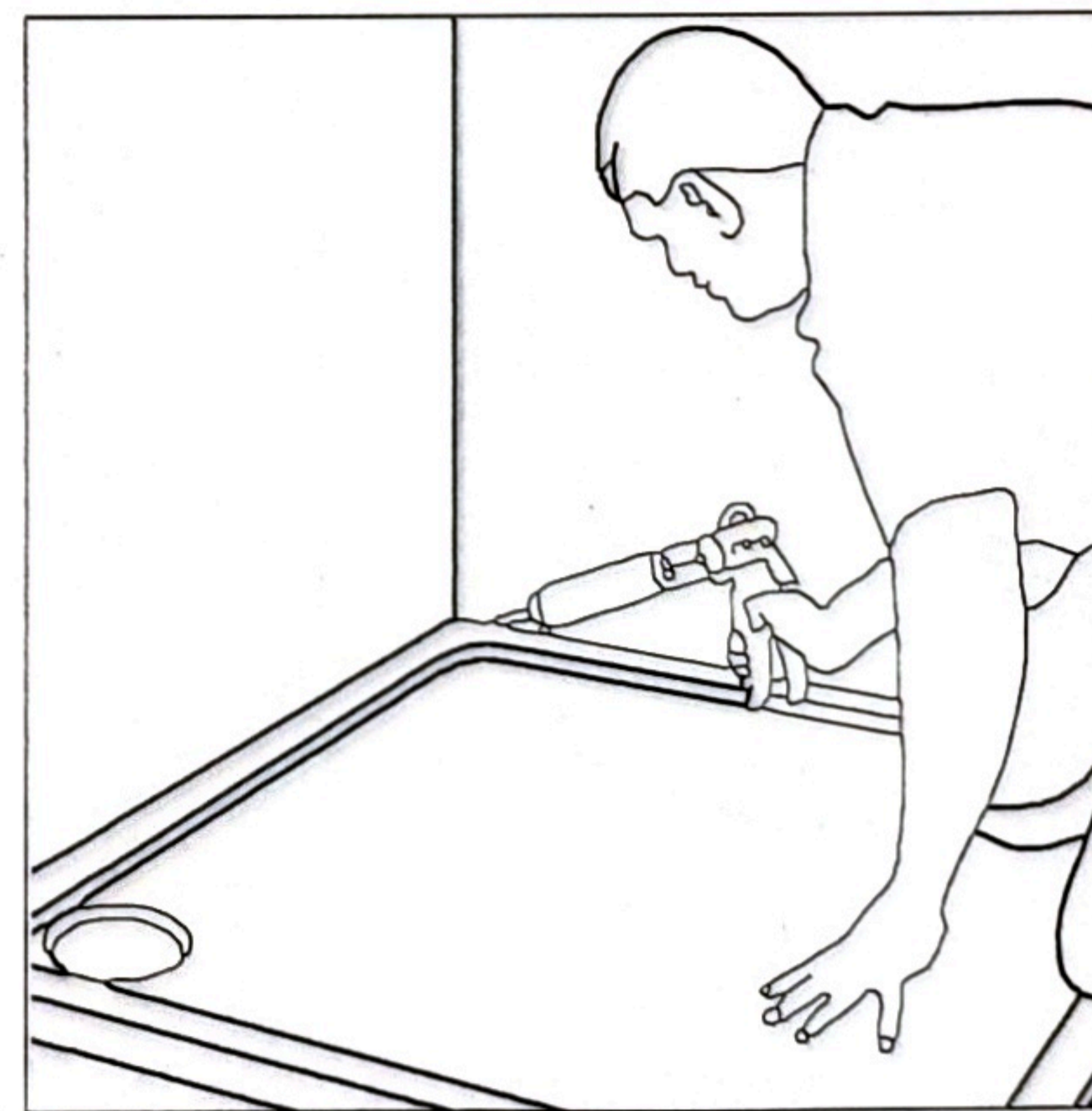

CLEANING-general

Use only warm soapy water and damp cloth/sponge on a regular basis. Do not use abrasive scouring powders, chemicals or aerosol cleaners-these may result in damage to the surfaces, in particular, the plated component parts.

Sealant drying times may vary in cold damp conditions and will be extended where thicker beads of sealant are applied. Allow sealant to dry completely before exposing to water.

We have taken great care to ensure that this product reaches you in perfect condition. However should any parts be damaged or missing please contact your point of purchase. This does not affect your statutory rights. In addition if you require replacement parts your point of purchase will be happy to assist.

7