

INSTALLATION AND OPERATING MANUAL

VIDALUX

Hydro Plus Range

**INSTALLERS PLEASE NOTE, THESE
INSTRUCTIONS ARE TO BE LEFT WITH
THE CUSTOMER**

Technical Support: 01524 489939

Warranty Claims Or Delivery Damage: www.vidalux.co.uk

VIDALUX CLEAR & BRIGHT WATER SOFTENER

Guaranteed to get rid of limescale

Live in a hard water area?? Limescale in the kettle and on bathroom fixtures?? Suffering from unknown adverse health effects from this polluted drinking water??

If you have a shower and any feature becomes blocked with limescale and stops working THIS IS NOT COVERED BY THE WARRANTY, as in reality it is not the products fault, it's the poor quality water it has been subjected to

GOOD NEWS - Designed in partnership with one of the UK's largest and most trusted water softener manufacturers, this sleek, easy fit model is GUARANTEED to work or your money back!! Remove all the limescale in a 1-4 bedroom home and benefit from the following

Better tasting drinking water - Easy to install - Guaranteed to work or your money back
No plumbing or chemicals – Cost as little as £2.00 a year to run and the improved condition of the water pipes will reduce your heating bills - Made in the U.K - Trialled and tested Over 10 years | Used by professionals



Thank you for purchasing this product. To guarantee the product delivers a long service life, please ensure it is fitted and used in accordance with the instructions contained in this booklet.



Please check that the boxes contain all the items listed below, and report to us any parts that are missing or damaged prior to assembly and within 48 hours of receipt. Damages notified to us after this time will be chargeable.

CAREFULLY CHECK THE PRODUCT IS AS ORDERED: CORRECT SIZE AND COLOUR OPTION BEFORE YOU COMMENCE ANY OF THE INSTALLATION PROCESS

You should ensure that the floor where the shower is to be located is smooth, level and able to support the weight of the product when in use.

Installation of the shower cabin is designed for a DIY installation. However any electric supply to the unit itself is required by law to be installed by a qualified trades person to ensure safety and quality. Failure to have the showers electric feed installed by qualified fitters will invalidate your product guarantee and be dangerous.

Please ensure that all connections are water tight, safe and insulated (where applicable) as the unit has connections that are made for transport purposes only and are not fully tightened.

Pack contents:

- 1 x Tray base with pre-fitted waste assembly
- 1 x Central, tower panel with pre-fitted body jets
- 1 x Shower Valve
- 1 x Control Panel And Fixings
- 2 x Framed, rear glass panels (marked left and right)
- 2 x Clear glass, curved doors
- 2 x Clear glass, fixed side panels
- 2 x Curved, polished frame sections
- 2 x Straight, polished frame sections
- 1 x Monsoon rain shower
- 1 x White Acrylic ceiling
- 1 x Hand shower, riser bar and chrome hose.
- 1 x Glass shelf and fittings
- 1 x Magnetic door seals (pair)
- 4 x Flapped door seals (2 different lengths)
- 8 x Twin wheels, shower door rollers.
- 8 x Door roller stoppers
- 2 x Chrome finished handles
- Fixing screws
- 1 x Roll of 'U' Seal

Refer also to contents list with images on the next pages.

No installation should take place until all items have been deemed cosmetically acceptable. Once installation commences all products then enter into their governing warranty periods and no returns can be accepted, by commencing with the installation you are accepting the goods cosmetic state with all 'workings' being covered by warranty. (contact us for more information before installing if required)

Hydro Shower Contents

Below is a list of the parts you should have received for the installation of your shower. Please note that several parts may be pre-fitted in place, such as the monsoon shower head, etc. Please note, the design and shape of parts may change occasionally but will always offer the same or greater functionality.

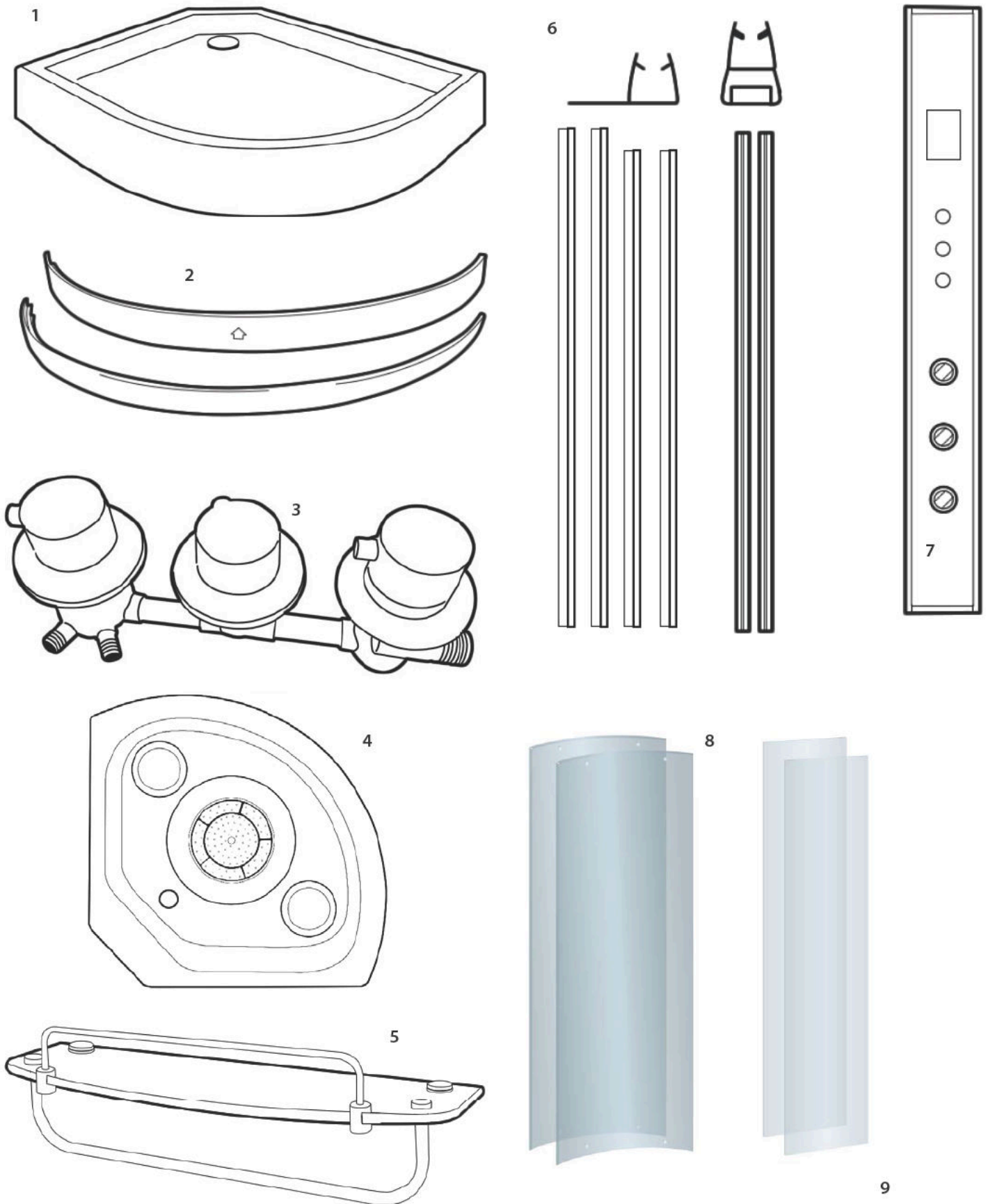

1. Tray/Base with Waste assembly and flexible waste pipe pre-fitted (shape and size vary according to model).
2. Two Curved polished Aluminium frame sections.
3. Thermostatic shower valve
4. Roof/Ceiling with Ozone, Monsoon and light fittings.
5. Glass shelf and fittings.
6. Two longer and two slightly shorter Flapped seals and a pair of Magnetic door seals.
7. Tower with and Body Jets , control panel and steam pod pre-fitted.
8. Two Curved clear glass doors.
9. Two flat static panels
10. Back Glass Panels. Pair of glass with Polished Aluminium frames.
- 11.. 8 Door stops, short fixing screws and cover caps.
- 12.. Two pairs of door handles.
- 13.. Hand Shower, riser bar, chrome hose and fixings.
- 14.. Eight Door wheel cams/runners. 4 x Quick Release, 4 x twin for upper rail fitting and 8 cover caps.
- 15.. Fixing Screws
- 16.. Electronics Box

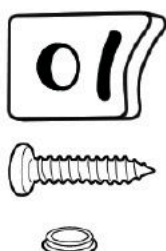
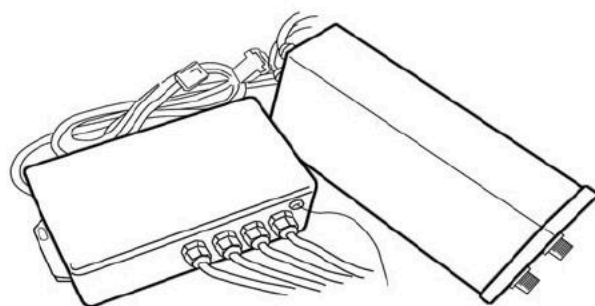
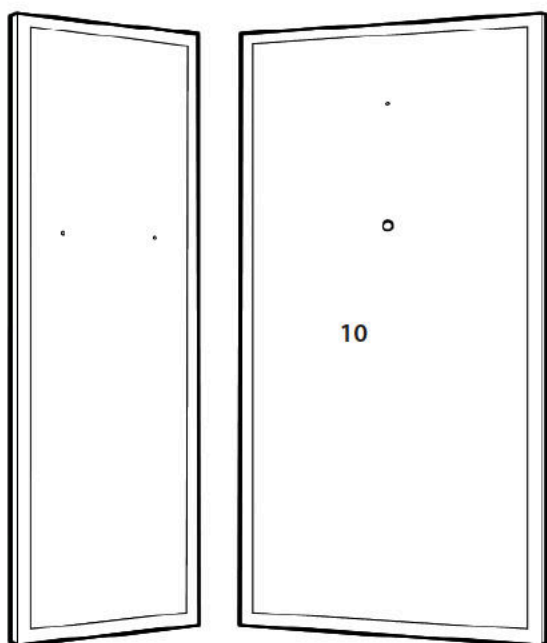
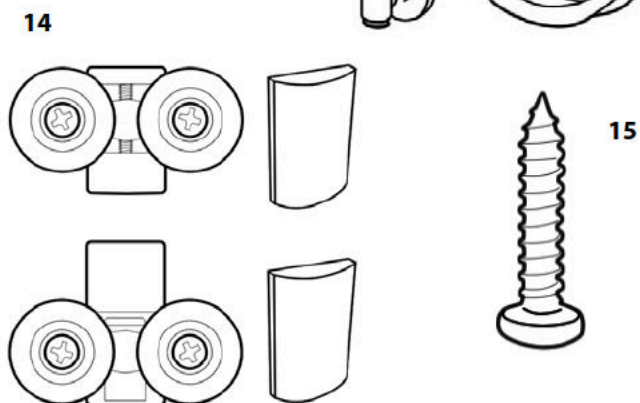
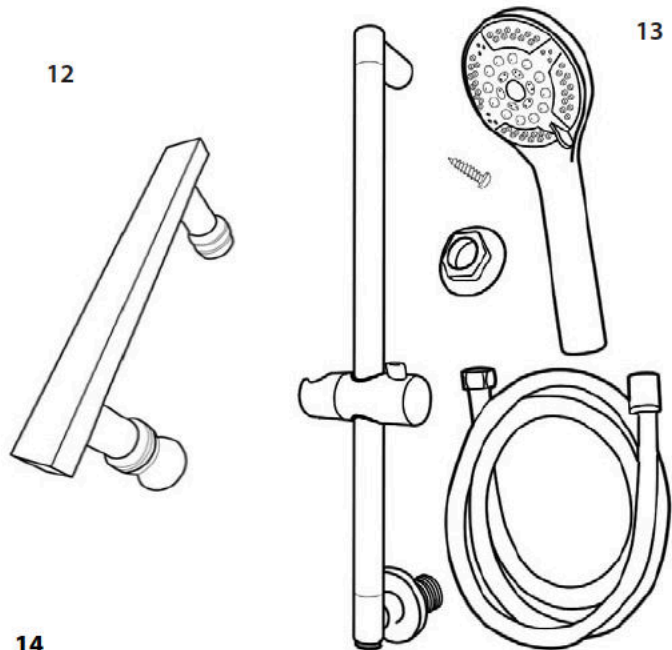

11.
x 8

YOU WILL NEED



This Shower requires 2 x 1 Metre Braided Hoses

Not Supplied

IMPORTANT NOTICE

Before you proceed with fitting your Vidalux Shower please read and understand the following:

By commencing testing and installation of the unit you are agreeing to the Terms and Conditions set out by us: copies of which are available by contacting us by email or by telephone (details on the cover of this manual).

You are required to ensure the purchased product dimensions allows for ease of passage to the intended installation area.

Regarding weight tolerances of installation area, it is advisable to contact a builder or refer to Building regulations to ensure the product placement area has sufficient joist/floor support.

1. It is important that you ensure that your purchase has been delivered undamaged. You are required to check the contents and report any damage that you feel needs repairing or replacing within 48hrs of receipt of goods. Items reported damaged after this time WILL be chargeable.
2. The product you have purchased is designed for home DIY fitting. You are only required under the Terms and Conditions to get any electrics feeding the shower installed by a qualified specialist. The product requires connection to electricity and this by law requires a Part P qualified electrician. Failure to provide evidence of this will void the relating product warranty
3. We are a supply only company. If you report to us any damage we will send replacements or solutions to remedy the problem described. We endeavor to fully understand the problem first by asking a series of questions and then propose the solution. We may even ask for digital images to be sent via email to assist the process. The warranty is parts only and does NOT include fitting/inconvenience or other related costs.
4. You are required to ensure that you correctly water test any bath tub before fitting and ensure that you/ your fitter fully tests the unit upon completion and attends to any leaks and faults before he leaves.
5. **All hoses, such as to the valve assembly, shower outputs and air switches and waste are fitted for transport purposes and need to be properly sealed and tightened before use.** During transportation some connections can become dislodged and therefore break any watertight seal, you are required to ensure that your fitter specifically tests for these possible occurrences and seal/fix accordingly.
6. **Do not book fitting until you have inspected the unit. We cannot be held responsible for delays and costs incurred by having to return to fit parts that need supplying.**
7. We cannot be held liable for inconvenience caused due to lack of bathing facilities caused by any delay in receiving your product or whilst awaiting parts.
8. Regarding our sales and technical support: We know our products and their requirements, but we are not qualified plumbers or electricians and accept no liability for claims suggesting the same. You are advised to check the suitability of the product with a professional body. It is the customer responsibility to ensure the product is fit for purpose.
9. A 'Completion Certificate' is included at the end of the manual where you should record the details of your installers - you will need this to record your warranty on our website. You **MUST** register the product warranty within 90 days following delivery

ATTENTION

ALWAYS FIT EASY TO GET TO ISOLATION TAPS ON BOTH THE HOT AND COLD WATER SUPPLY (NOT SUPPLIED). JUST LIKE A DISHWASHER OR WASHING MACHINE, THIS PRODUCT MUST BE ISOLATED WHEN NOT IN USE.

REMEMBER:

These showers are designed to be free standing and movable from their location should you have the need to replace anything. ALWAYS USE Flexible braided water inlet pipes (not supplied) at least a metre long (not central heating plastic type!)

Always use a flexible waste pipe from your house supply to the shower .
NEVER FIX with rigid pipes, NEVER FIX the unit to the wall.

Before you begin



Assembly requires two persons.

Tools needed to assemble this shower cabin:

Electric screwdriver with a selection of heads, regular screwdrivers, pipe grips, spanners, spirit level, sharp knife and rubber mallet. Connection of the electrical supply and plumbing may require additional tools.

Do not fully tighten any screw fixings initially during build as this allows the frame to move a little and aid location of all holes and screws; remember to fully tighten before completion and subsequent use. There is a drill bit supplied with the kit, to allow either widening of holes or drilling new holes which you feel cannot be located during construction.

Water requirements

This shower requires two water supplies (1 x hot and 1 x cold) tested to be between 1 and 3 bar, with a flow rate over 7.5 litres per minute.

NOTE: We recommend water pressures over 2 bar to achieve optimum showering results.

Gravity Fed systems

If you have a Gravity fed system, then fitting a Shower Pump will almost certainly be required. Fitting a Shower pump rated over 1.5 bar is necessary as a minimum. Shower pumps MUST be properly sited, installed and commissioned. Incorrectly installed shower pumps will cause adverse affects to your showering and bathing resulting in pulsing or starting and stopping of the pump. If a pump is installed, a separate Mains Cold supply must be fitted and directed to supply the Steam Generator separately (bypassing the pump).

Isolating Valves

You MUST fit isolation valves to the shower unit on both hot and cold incoming feeds as it enables you to turn off the water supply to the shower when not in use (for example going away on holiday). Additionally isolating valves makes service checks easier than locating the house stop cock.

Electrical

This model requires an electrical supply, this MUST be in the form of an ISOLATED FUSED SPUR. It is both illegal and dangerous to fit this shower to a plug socket in a Bathroom environment. The product may be supplied with a plug, this is pre-fitted for testing purposes only and should be removed to complete the install.

DUE TO THE NATURE OF THIS PRODUCT WE HIGHLY ADVISE THE PURCHASE AND FITTING OF A WATER SOFTENER

(PLEASE NOTE LIMESCALE BUILD UP MAY CAUSE DAMAGE TO YOUR SHOWER AND WILL NOT BE COVERED UNDER WARRANTY)

Assembly

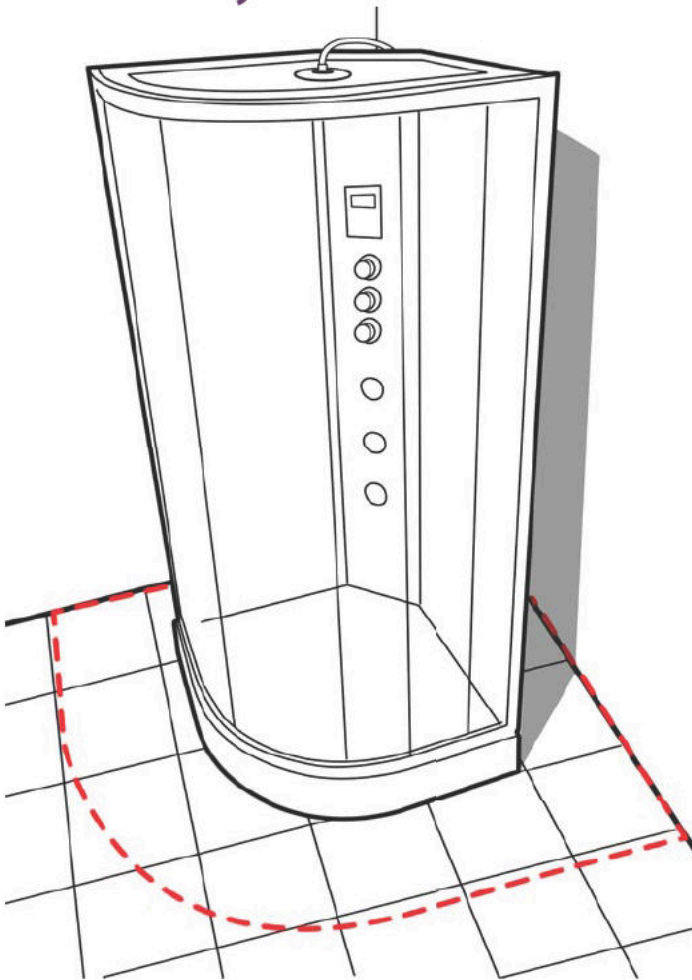

Do not fit the shower into locations where you do not have at least 40cm access all around the cabin both for installation and for future service access.

We advise you do not fit sinks, toilets etc that restrict access behind the shower.

You must ensure you can slide the cabin away from the wall/corner for service access.

Smooth and level walls and floor are required for ideal installation conditions. Avoid carpet or vinyl floors.

Please ensure you have correctly water tested the tub before you continue.

NOTE: Instructions shown based on quadrant model, The assembly and operation is identical for offset models except for the rear panels being different sizes.

Please inspect all parts carefully before assembly.

BY COMMENCING ASSEMBLY OF THIS SHOWER YOU ACCEPT THAT THE PARTS HAVE ALL BEEN CHECKED AND ARE UNDA



This product is fitted with toughened safety glass. The glass is stronger than regular glass and if it breaks it will form small pieces of cubed glass, not

dangerous shards of glass. These small pieces are still sharp, so care must be taken to handle broken glass with care.

If the glass is put under stress or is chipped it will break.

DO NOT ALLOW THE GLASS TO IMPACT HARD SURFACES OR OBJECTS AS THIS MAY CHIP/WEAKEN THE GLASS. WEAKENED GLASS THAT IS CHIPPED OR UNDER TENSION MAY SHATTER AT ANY TIME, NOT ALWAYS IMMEDIATELY.

FITTING SEAT (OPTIONAL)

If your product came with a seat you may choose to install this item.

Before commencing full assembly of the product you will need to prepare and fit the seat.

You need to drill three holes for the fixing bolts into the tower at your preferred height.

Ensure to use the seat strengthening plate provided

Remove the three fixing nuts from the threaded ends on the rear of the seat fixing plate.

Pass the threads of the seat through the holes from the front of the tower panel.

At the rear, pass the threads through the white support piece (white plastic) and then fasten the bolts to hold.

Ensure the bolts are FULLY tight.

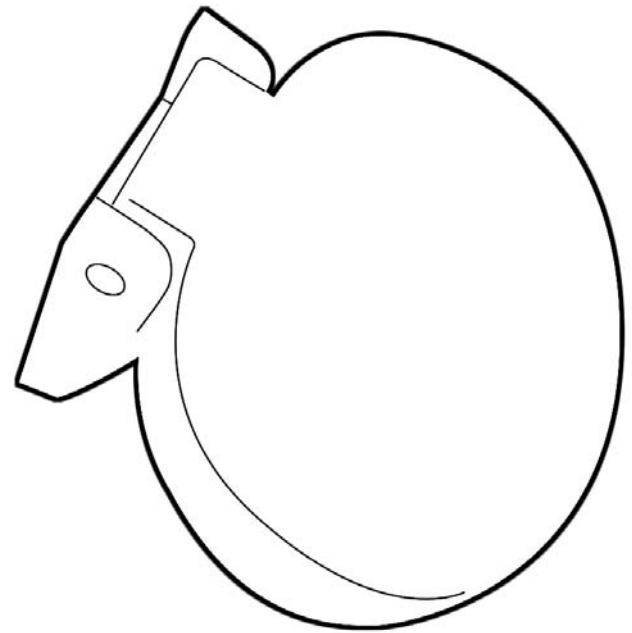

**The seat has a MAX allowance
for use of 100kg**

Take measurements carefully
from the back of the flip seat

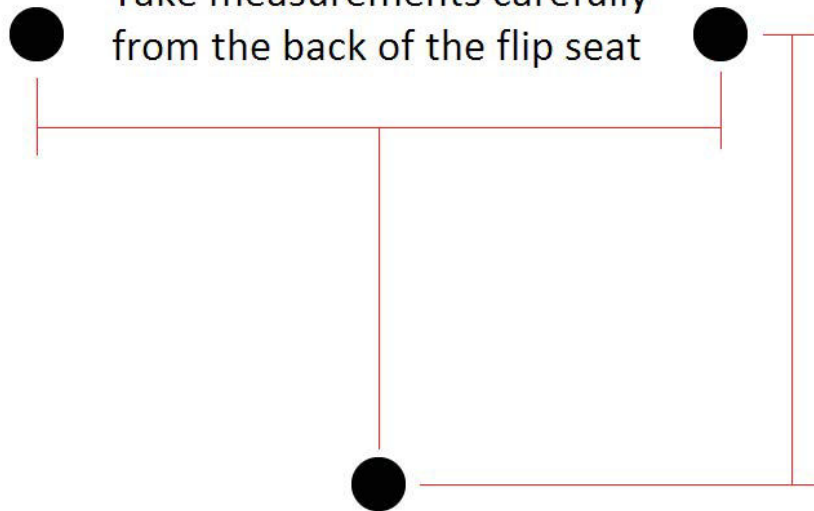

**BE SURE TO USE THE BACK STRENGTHENING PLATE
PROVIDED**

LEVELING AND FITTING THE TRAY

Remove the protective film covering the base.

Connect the soil pipe, trap and any couplings to the flexible waste under the tub. You may choose to fit either a HEPV0 trap with the appropriate couplings or choose to fit a McAlpine ST28M coupling to a McAlpine 28-NRV trap.

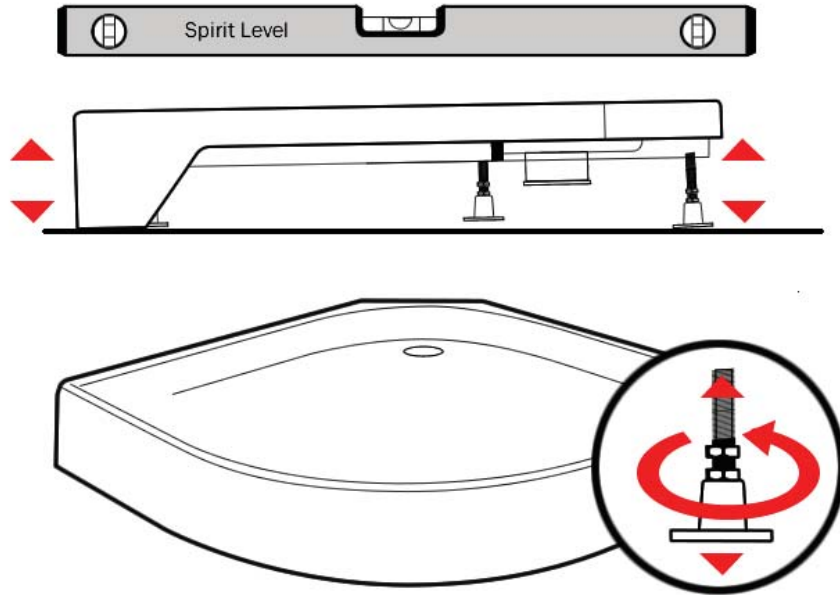

Position the tub base in what will be its final location and adjust the feet until the base is level. You can raise/lower the feet under the tub and with a spirit level laid across the tub, ensure the tub is level.

Now fill the base with some water and check that the water flows adequately to the plug and exits satisfactorily. If the water does not flow to the plug fully, then you will need to increase the fall on the tray by adjusting the legs. If the water does not exit the waste section fast enough, then ensure there is suitable fall in the waste pipe and/or no blockage or kinks in the pipe work.

Check and attend to any leaks.

Now slide the tub away from the wall to allow access all around the shower as you assemble.

This product is freestanding so you do not need to fix the feet to the floor.

FITTING THE CONTROL PANEL

Simply remove the paper backing to the waterproof sponge to reveal the sticky backing. From the front of the shower offer the control panel into the void on the center control tower and press lightly into place.

Once in place, from the back of the tower use the 4 screws and washers to firmly secure the control panel.

Again coming to the front of the shower, now press hard and firmly on all edges of the control panel to further seal and then tighten screws once more



REAR PANEL ASSEMBLY

Locate the two rear, framed glass panels.

The inside edge to go to the center control panel will be flat. The outside end to connect to the frame work will have a 'T' end and 90 degree return

NOTE: A bead of sealant MUST be run between the joining faces of the back panels to the Center Tower to provide an extra level of water protection.

Do not worry about making a slight mess. You will remove any excess sealant once the panels have been fixed into position. DO NOT PUT SEALANT IN TO THE WATER CHANNELS

You should consider doing this on all panels with meeting faces then simply wipe off any excess so none will be 'on show'. This includes under the back panels and center control tower where it sits on the tray

First, attach one panel to the center column with a fixing in the top and bottom of the column to the rear panel. This will offer some stability. Do not fully tighten yet

Now continue to fix the remaining back panel. At this point you can add all the remaining fixings to both sides, making sure everything is aligned and level and fully tighten each

DO NOT SCREW THE PANELS TO THE BASE JUST YET

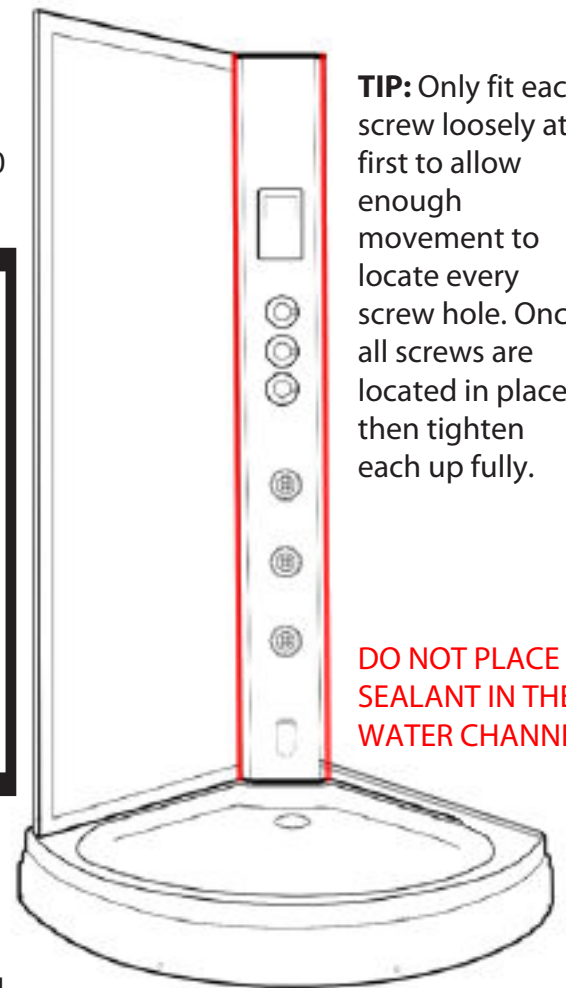
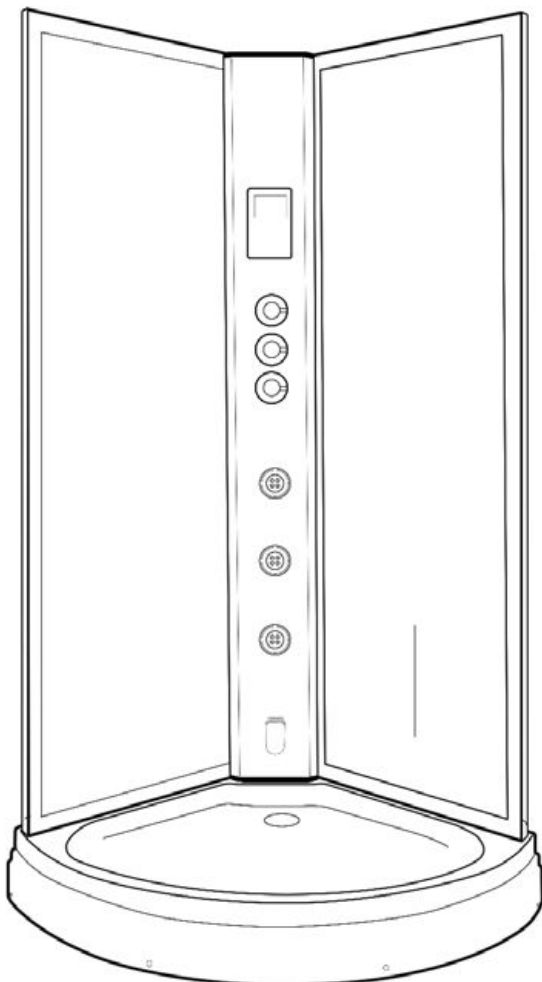

TIP: Only fit each screw loosely at first to allow enough movement to locate every screw hole. Once all screws are located in place, then tighten each up fully.

DO NOT PLACE SEALANT IN THE WATER CHANNELS

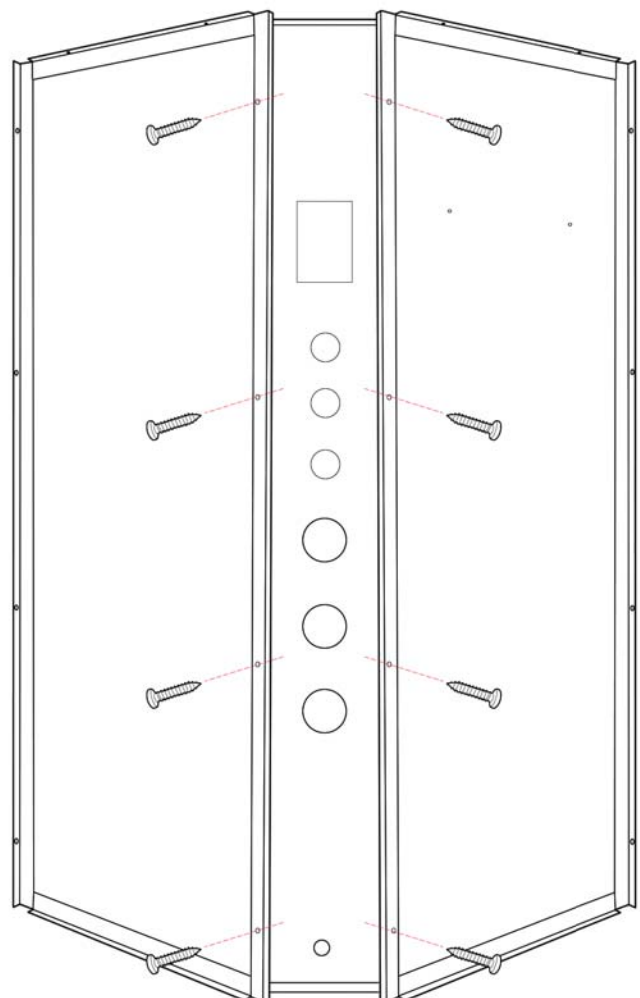

FRONT FRAME

Locate the two silver coloured upright frame sections and the two curved frame rail sections. You will need the 8 x LONGEST screws to join these sections together.

The inside facing edges of the rails will be tapered, while the flat edge will meet the tray and the other will be closest to the bathroom ceiling.

In turn, align the two holes in the uprights with the two holes in the upper and lower curved rails. The screws pass through the holes in the side of the upright and fasten into the curved rail as shown in the diagram

DO NOT FULLY TIGHTEN THE SCREWS - ALLOW SOME MOVEMENT IN THE FRAME FOR INSTALLING THE FIXED GLASS

PLEASE NOTE: The uprights have 'cut out sections' that go over the trays lip, therefore these are positioned at the bottom

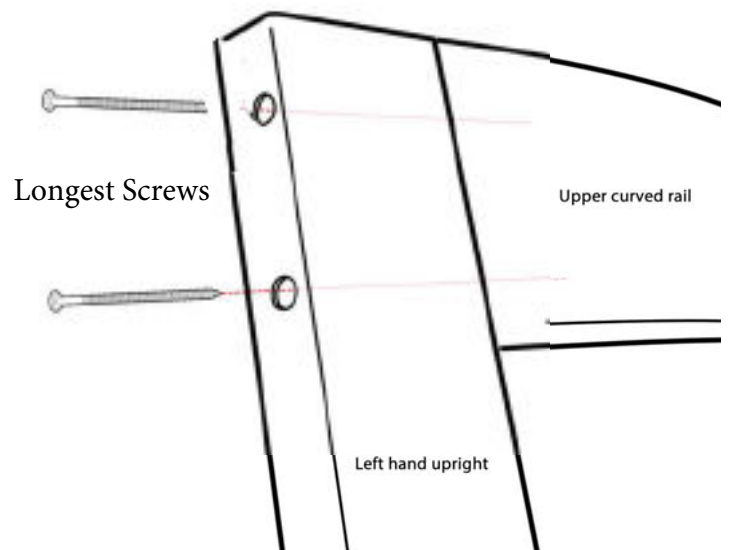
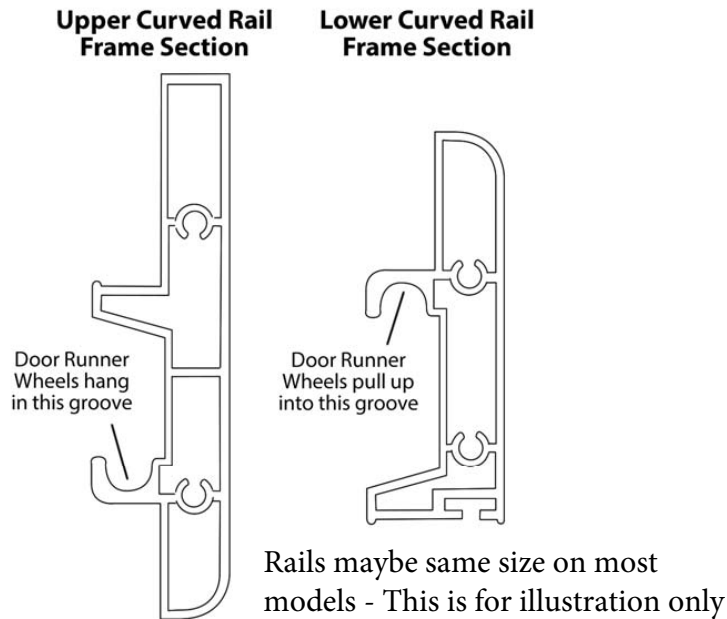

FITTING THE FRONT FRAME

Place the front frame in to position and align the back panels and center column on the tray for fixing

NOTE: A large bead of sealant MUST be run between the back panels and Front Frame work to provide an extra level of water protection.

Simply wipe off any excess so none will be 'on show'

Align the uprights with the rear glass panels so that the fixing holes line up.

To help ease this process, you may need to use the supplied drill bit in the holes to ensure they are wide enough and clear.

From behind the shower locate the screw holes into the front frame through from the backpanels to secure in place. (8 x short screws)

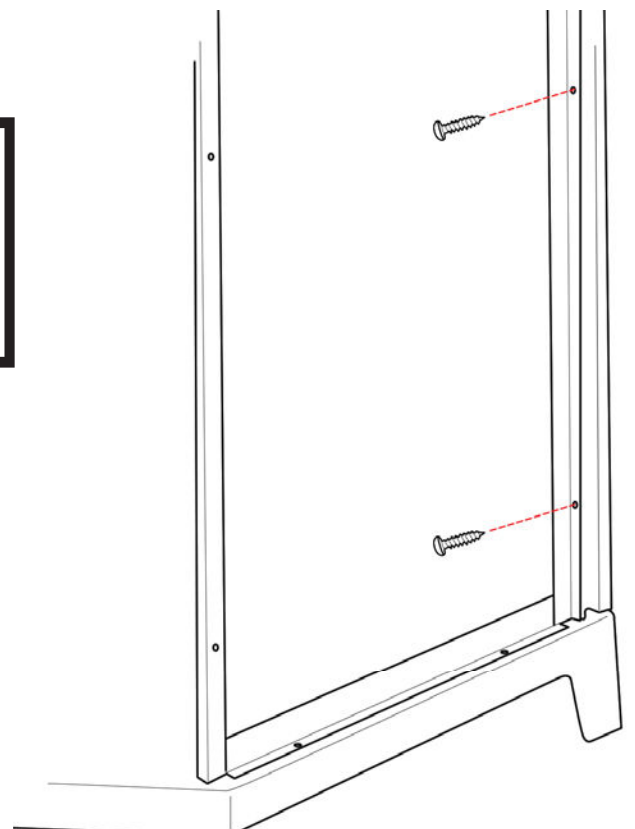

POSITION THE FRONT

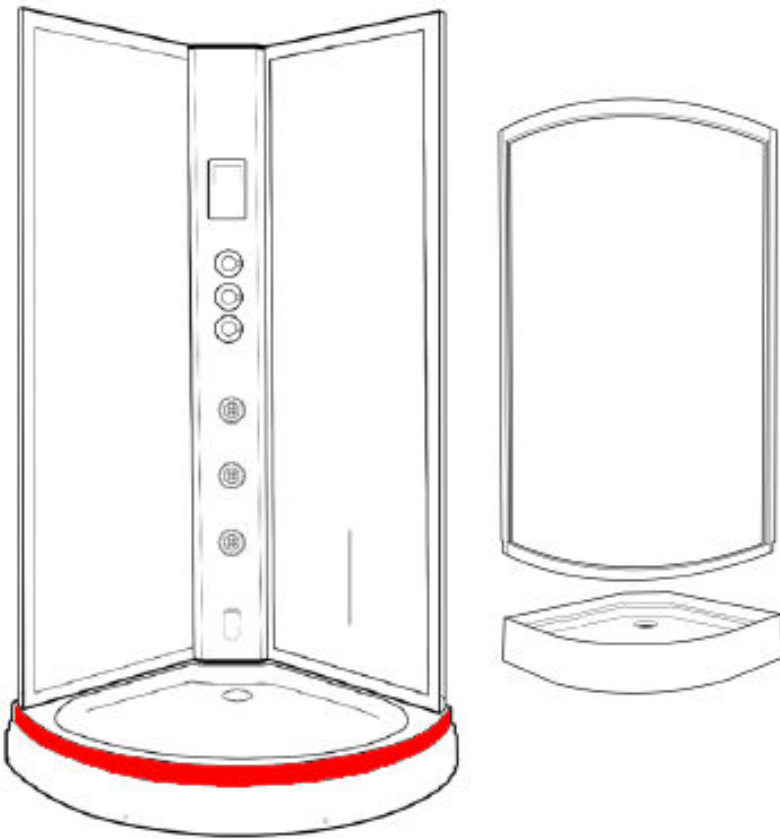

IMPORTANT

To allow the wood tray insert (if purchased) to fit inside the tray **YOU MUST** ensure the front framework is positioned / pressed as close as it can comfortably sit, against the surrounding front lip of the shower tray

Should the front frame sit too far away from the front lip. This may result in the wood insert coming into contact with the door wheels

Please ensure there is a minimal gap

FIXING THE BACK PANELS TO THE TRAY

The rear glass panels can now be fixed to the tray. Wipe away any excess sealant once completed

At the rear of the shower the lip of the frame has fixing holes to enable the screws provided to be used to fasten the rear glass panels to the tray. There are 4 fixing points.

Fixing is done with the short screws provided. First use the drill piece provided to create pilot holes without passing all the way through the tray, then when fixing, you may wish to squeeze silicone into the holes before screwing to ensure its water tight

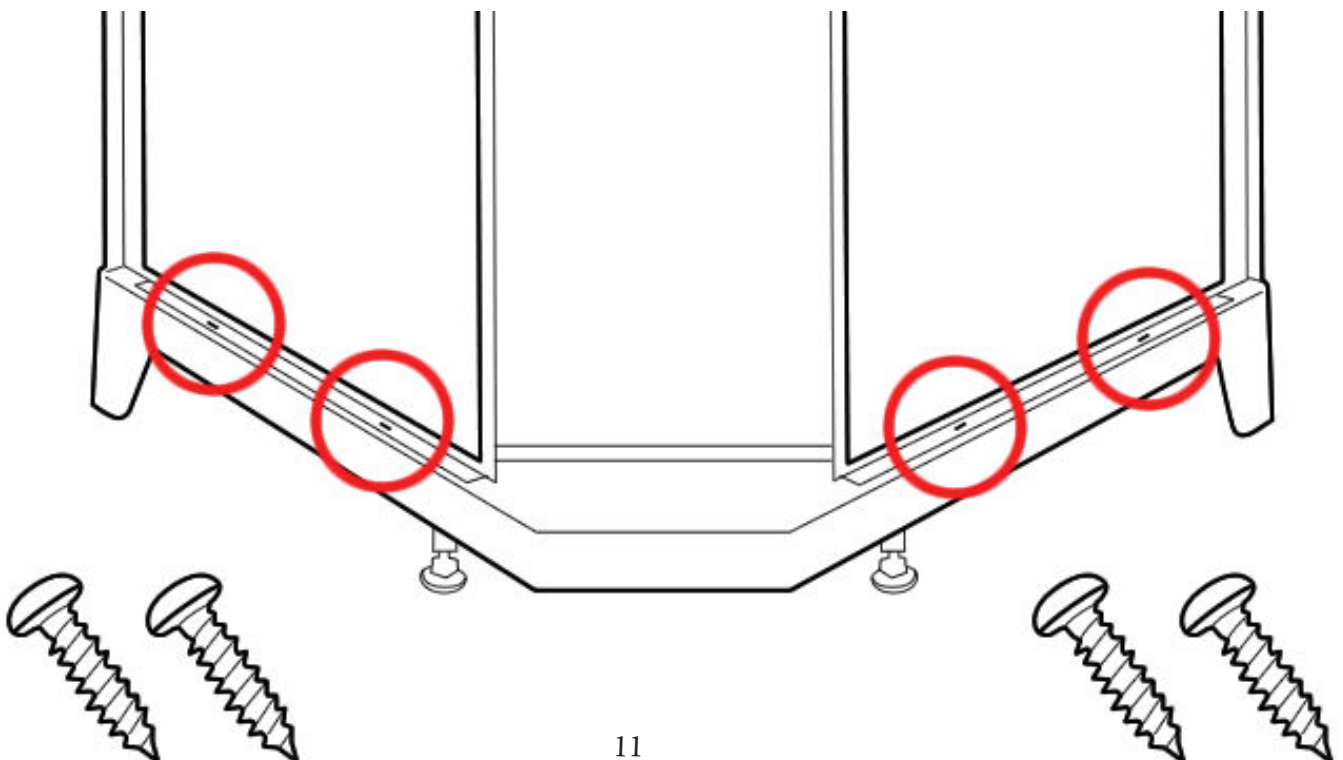

INSTALLING THE FIXED SIDE GLASS PANELS

Locate the two fixed glass panels. These are different from the doors as they do NOT have any holes pre-drilled.

Now position this glass panel up to the frame pushing the long edge of the glass into the upright of the frame until FULLY bedded into the frame upright.

Locate the roll of Insert rubber seal.

Cutting to size, take the insert seal and push it on the inside of the shower down the long edge between the fixed glass and framework. Trim any excess leaving it running the full length. Ensure the trim is tight to the bottom.

This MUST be done from the inside of the frame. The glass will sit within a lip on the inner surface of the curved rail both top and bottom.

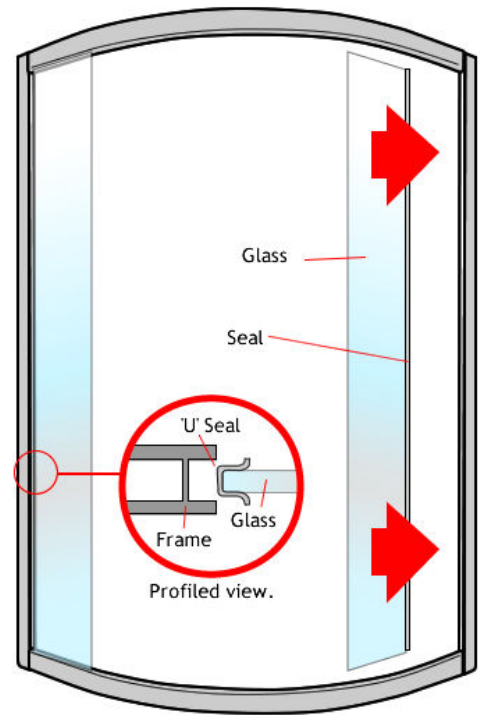

DO NOT HIT GLASS WITH HARD OBJECTS TO PUSH INTO THE FRAME.

View from Top Down

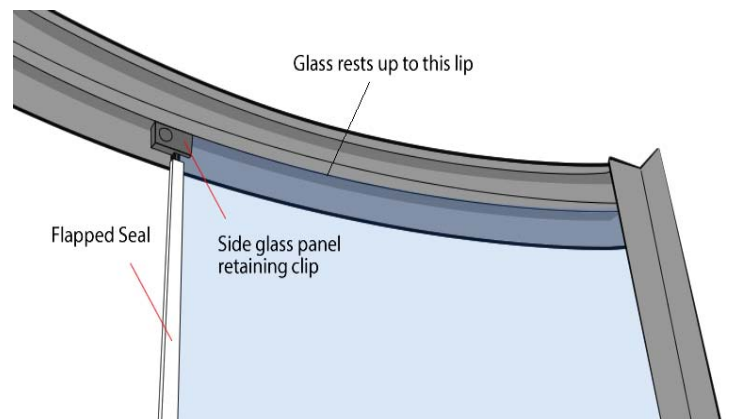
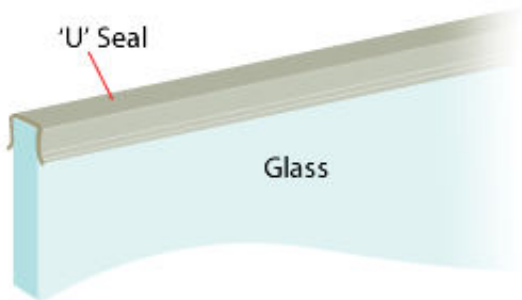
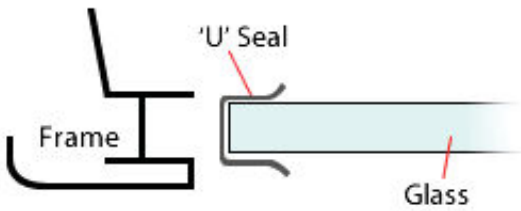

Now both glass panels are fully inserted into the uprights you can tighten up the four corners of the silver framework which will not hold the glass in position.

GLASS RETAINING CLIPS

Next you need to fit the Retaining Clips to hold the glass firmly. Position a clip tight up to the glass on the inside of the upper and lower rails, mark the position and drill a small hole then fix a screw to hold the clip in place. Repeat top and bottom on both fixed glass panels.

CAUTION WHEN DRILLING - ONLY DRILL THROUGH THE INNER SINGLE LAYER OF FRAME

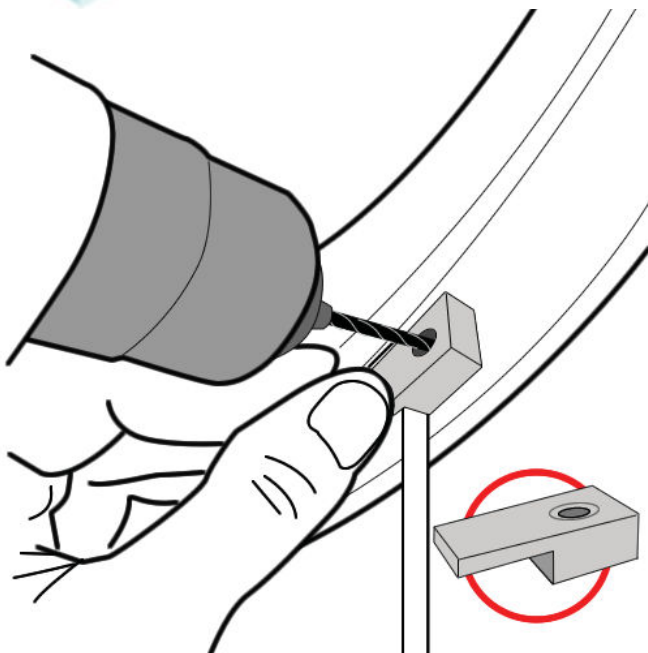

SHOWER CEILING

Remove the protective film from the roof/ceiling.

If not already pre-fitted, fit the monsoon rain shower head into the centre of the roof. It is held in place with a retaining nut located on the outer/upper face of the roof.

You can now place the ceiling onto the shower. The front will sit behind the front silver frame and the rear will rest on the top of the rear glass panels.

The speaker, fan, and light will be pre-fitted. Ensure all the cables are unraveled to enable location and connection at a later stage.

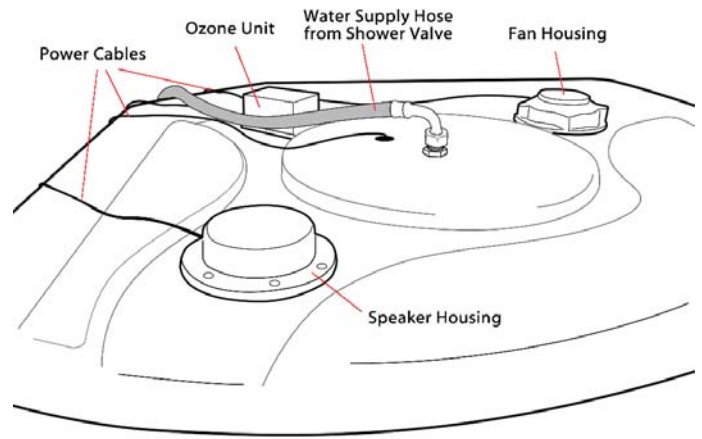
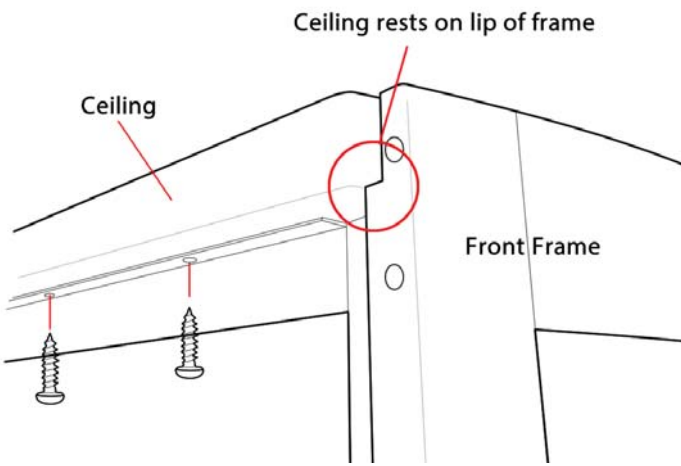

The ceiling is fixed in position by fixing up through the holes in the rear panel, into the ceiling. You can make use of sealant to hold the roof to the side walls and front or by carefully adding screws through the roof and in to the framework, however care should be taken not to miss the frame when creating any holes

Now ensure all the cables for the ozone, light, fan and speaker are hanging down the back of the shower ready to connect.

REPLACING THE CEILING LIGHT

Your shower is fitted with an LED 'Halo' Ring light. This light should provide a long service life if used correctly. If you need to change your ceiling light once the shower is installed, please turn off the water to the shower first, then disconnect the water supply pipe to the monsoon rain shower on the roof of the shower. Loosen the retaining bolt for the monsoon and lower into the shower. (we suggest you have another person inside the shower to hold it from falling).

From inside the shower with the monsoon removed, the light diff user cover will also come free. Disconnect the power cable to the light on the roof of the shower, unscrew the retaining screws for the light and remove.

To fit the replacement, simply reverse the process.

Before You Fit The Doors You May Wish To See The "SEALING THE SHOWER" Section Of These Instructions And Apply Sealant Around The Base Of The Tray Prior To Fitting The Doors

FITTING THE SHOWER DOOR WHEEL RUNNERS

Locate the pack of 8 twin wheel shower door runners (cams).
There are two different types provided.

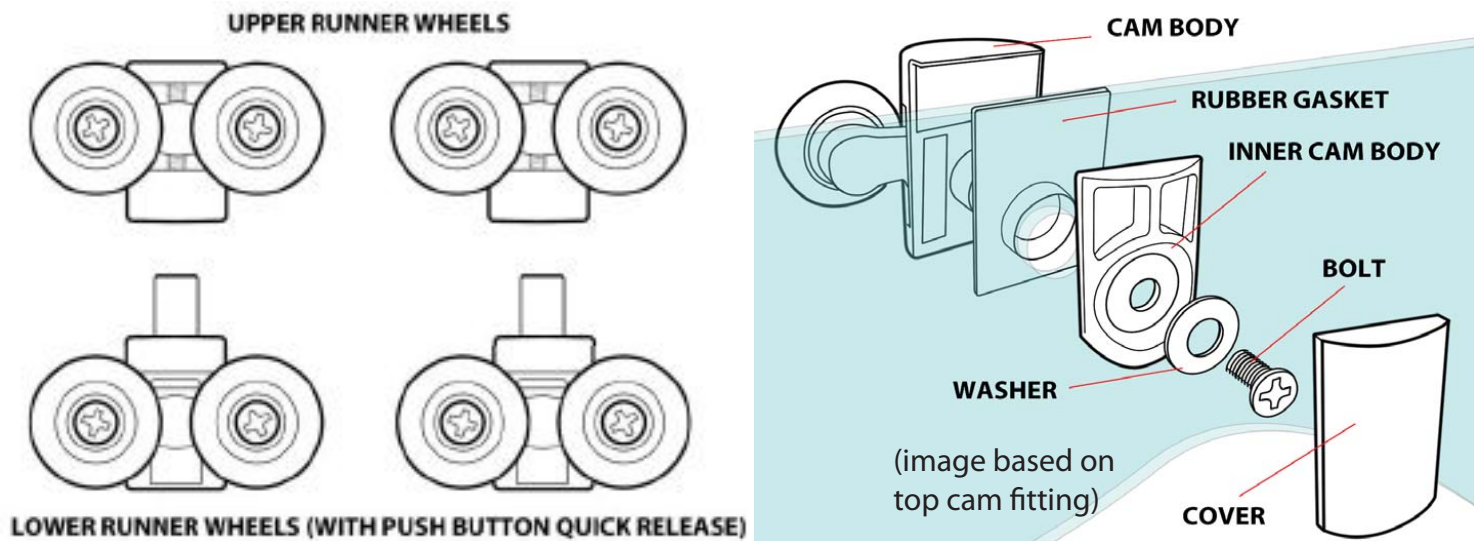

To fit each of the cams, first select the appropriate cam for the position on the door:

- 4 x Push button/Quick release for the lower position on the doors.
- 4 x Standard non push button for the upper position on doors.

Position the Cam Body on the outside facing side of the door (curve pointing outwards). Place the clear rubber gasket between the cam body and the glass. The gasket will fit into the hole on the glass.

On the inside of the door, position the grey plastic inner cam body, then washer and bolt.

Now tighten the parts together with the bolt until firmly held in place.

DO NOT OVER TIGHTEN AS YOU MAY BREAK THE GLASS

With the cam fixed in position, slide on the Chrome finished cover.

Repeat this process of all of the cam wheels.

TO HANG THE DOORS

From inside the shower position the upper wheels into the running tracks on the inside curve of the upper curved rail and then let the door hand down. From outside the shower, move the door to what would be a closed position and press the quick release buttons on the top of the lower cams and move the wheels to fit into the lower runner tracks.

Repeat for the other door.

DOOR STOPS

On the inside curve of the upper and lower rail are some holes pre-drilled. Fix each of the 8 door stops at these locations with the provided screws.

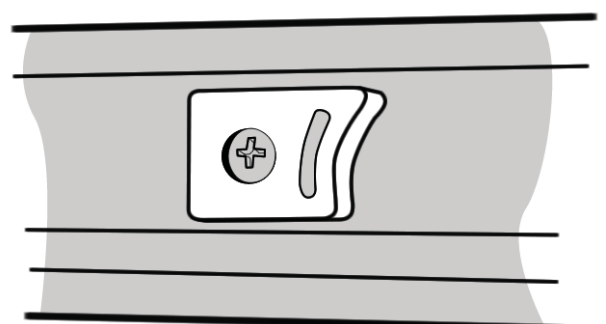

FITTING THE DOOR HANDLES

Each of the two shower doors requires a pair of chrome finished door handles to be fitted.

Each handle is comprised of several parts. Position the main handle part on the outside of a door ensuring the Chrome Washer and a Clear Washer are positioned also on the outside face over the thread. Push the threaded ends through the glass. Next place another clear washer on the threads and then screw on the two different Chrome Knobs to the inside of the glass door. Tighten until secure. **DO NOT OVER TIGHTEN.**

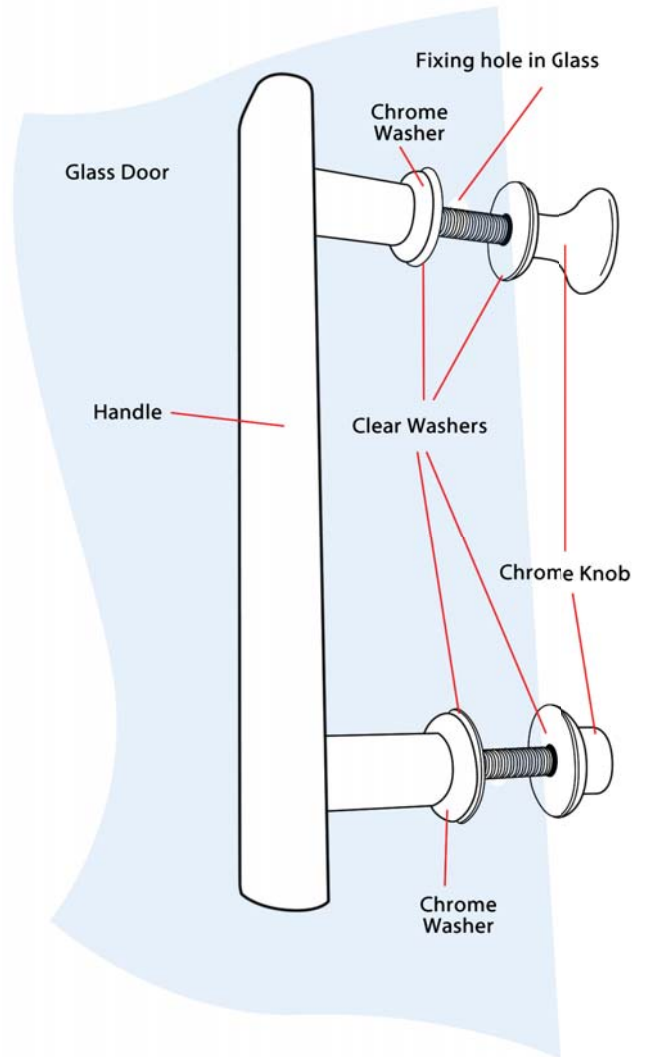

OVERHEAD/MONSOON SHOWER

The overhead shower is fitted into the ceiling from the inside. The overhead shower first passes through the light diffuser cover (inside the shower), so that the threaded end of the overhead shower passes out through the ceiling. Fit the **FIXING NUT** onto the threaded end on top of the ceiling to hold the shower and diffuser cover securely in place. Next locate the water supply hose coming from the shower valve this is identified as being the overhead water feed. Fit the threaded end of the water supply hose onto the overhead shower's threaded section and tighten.

REMOVE THE PROTECTIVE FILM ON THE FACE OF THE MONSOON BEFORE USE.

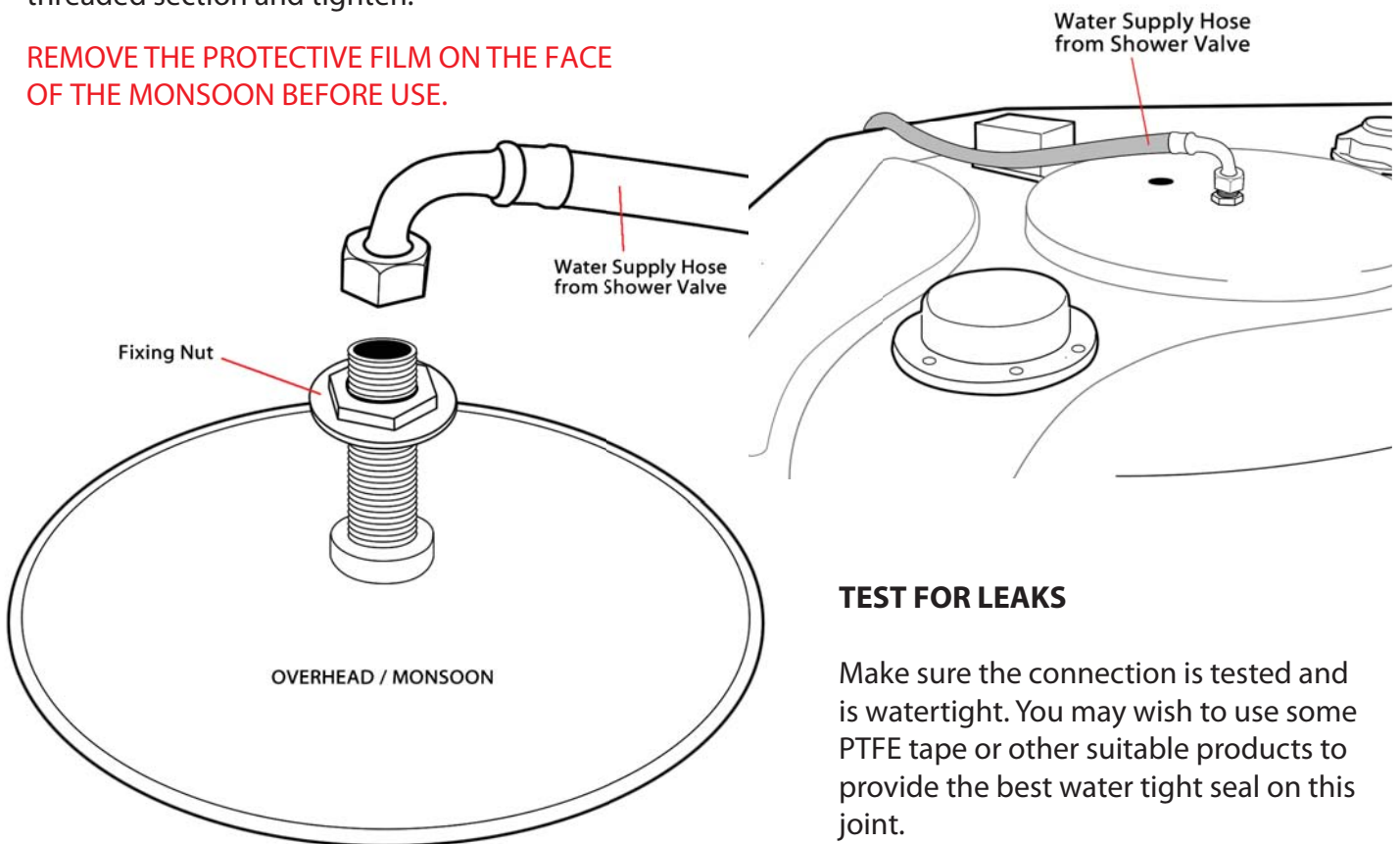

TEST FOR LEAKS

Make sure the connection is tested and is watertight. You may wish to use some PTFE tape or other suitable products to provide the best water tight seal on this joint.

HAND SHOWER AND RISER

You are now ready to assemble and connect the hand shower.

The hand shower comprises of:

- Multi function hand shower
- Chrome finished riser bar
- Hand shower holster
- Chrome water hose
- Rear retaining nut
- Fitting screw

The lower part of the riser bar has a threaded water connection. Position this part through the larger hole on the rear glass panel.

Fit the rear fixing nut from the rear of the shower to hold in place. Secure the upper part of the riser bar with the screw provided. Tighten both until secure.

Connect the silver hand shower hose to the lower part of the riser bar and the other end to the hand shower head.

At the rear of the shower, locate the grey water supply hose coming from the shower valve and connect to the water inlet of the riser bar. Test this water connection to ensure it is water tight. Using some PTFE tape or other product may help to achieve the best watertight connection.

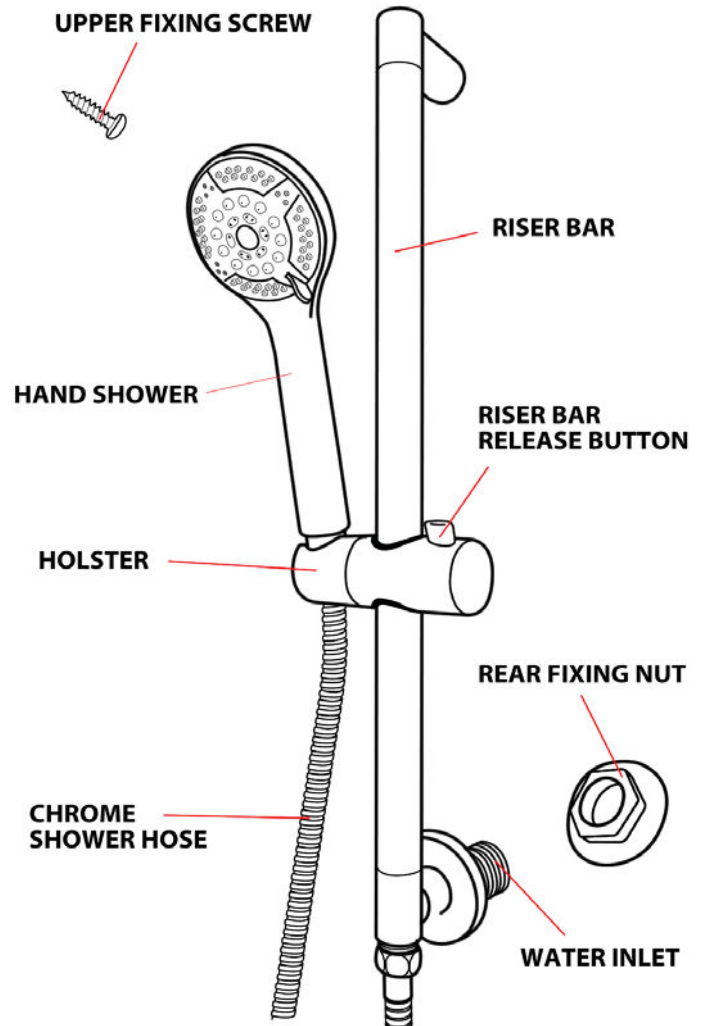

GLASS SHELF

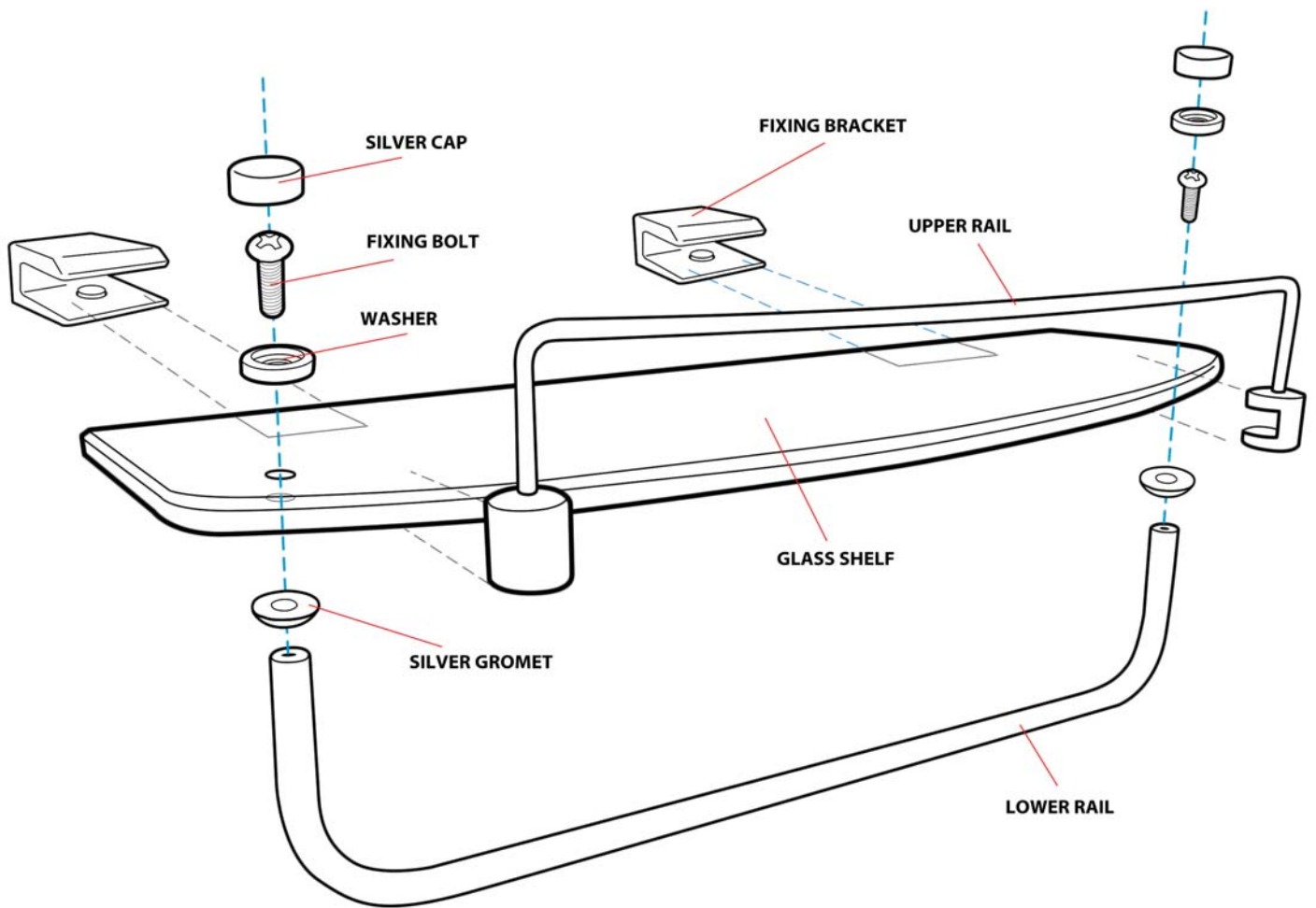

Assemble the shelf fully before fitting into the shower.

Position the lower chrome rail over the holes in the glass on the underside of the shelf with the silver grommets positioned between the two.

On the upper side of the glass, pass the bolt through a washer and through the hole in the glass and fasten into the end of the lower rail.

Repeat the previous step on the other end of the lower rail so that the rail is securely fixed in place. Take the two silver caps and fit them over the ends of the washer and bolt to provide a clean finish.

The upper rail pushed over the glass from the front. Using a flat head screwdriver, tighten up the fixing point of the front rail, which is located on the underside.

Position the two fixing brackets onto the inside of the rear panel of the shower in the holes provided. Fix the brackets at the rear of the shower with the supplied bolts and washers.

Place the glass of the shelf centrally into the slots of the brackets and then tighten the fixing points on the underside of the brackets to hold the shelf in place. **DO NOT OVER TIGHTEN THE BRACKET CONNECTIONS AS THIS MAY BREAK THE GLASS.**

SHOWER VALVE

The shower valve can be accessed from the rear of the shower and is located on the central tower.

The valve is divided into three parts that are joined together.

The uppermost part is the diverter. There are three connections able to be made here. One to the overhead shower from the outlet pointing upwards, another to connect to the body jets and the third connects to the hand shower/riser bar water inlet.



When making the connections, ensure they are water tight. Check all pre-fitted hoses as these may only be hand tight during manufacture.

The middle part of the valve handles the water on and off. There are no connections to be made here.

The lower part of the valve has three connections to be made. The HOT and COLD water supplies from your property connect to the outermost connections - ENSURE THE FEEDS ARE THE CORRECT WAY ROUND. The third connection is a cold water supply from the valve and connects to the WATER IN on the steam generator.

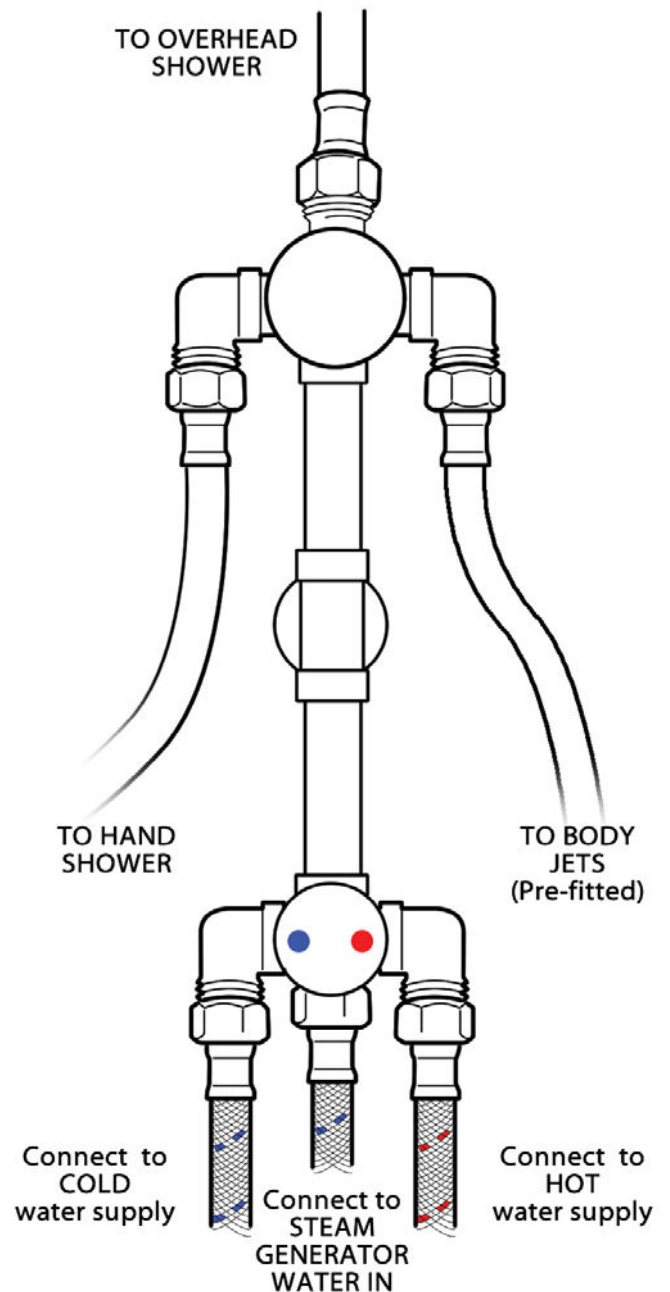

SHOWER SEALS

This shower comes with 2 flapped shower seals that are in two different lengths.

LONG FLAPPED

The longer flapped seal fit onto the **trailing edges of the doors**.

The seals are not designed to touch the glass or each other, but when the doors are closed they will reduce the gap to a level that water is unlikely to escape.

MAGNETIC

The magnetic seals fit onto the doors where they meet.

Ensure all seals are fully fitted onto the glass, especially the magnetic seals, so that they form an even seal.

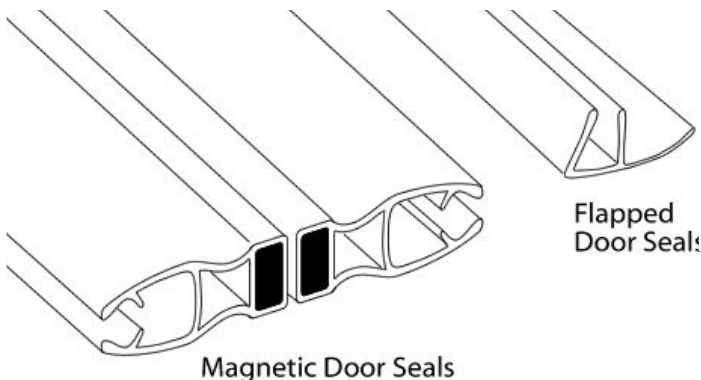
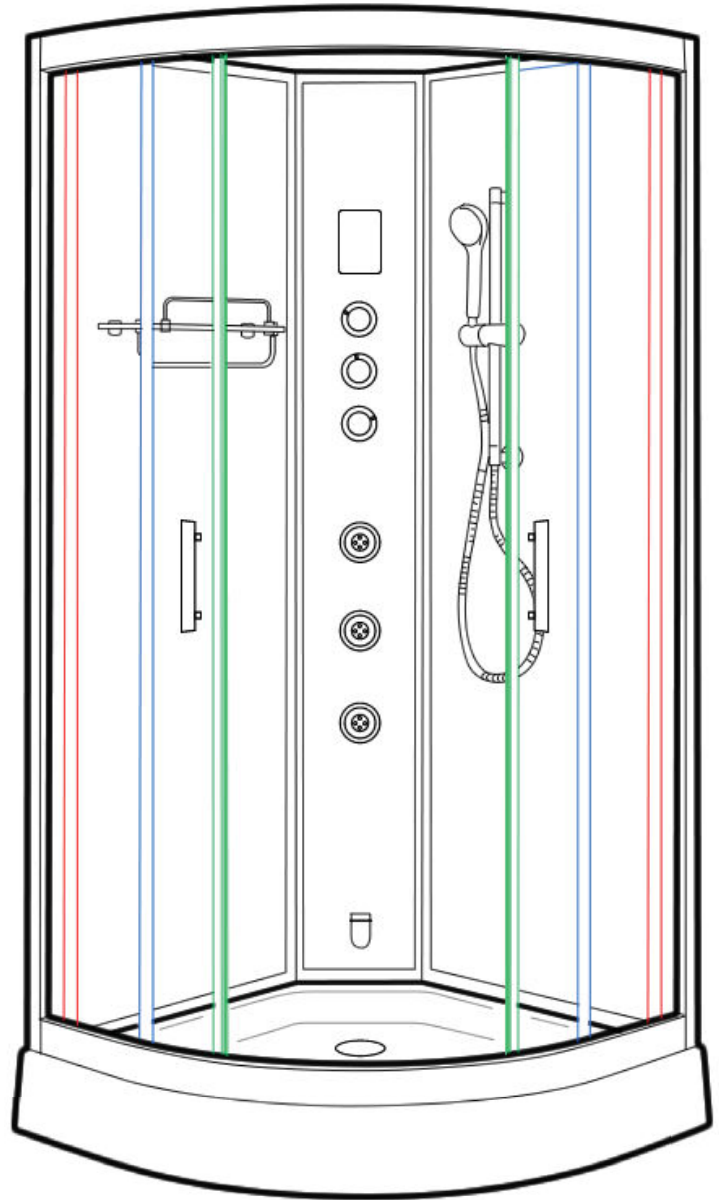

- Longer Flapped Seals
- Magnetic Door Seals
- Shorter Flapped Seals

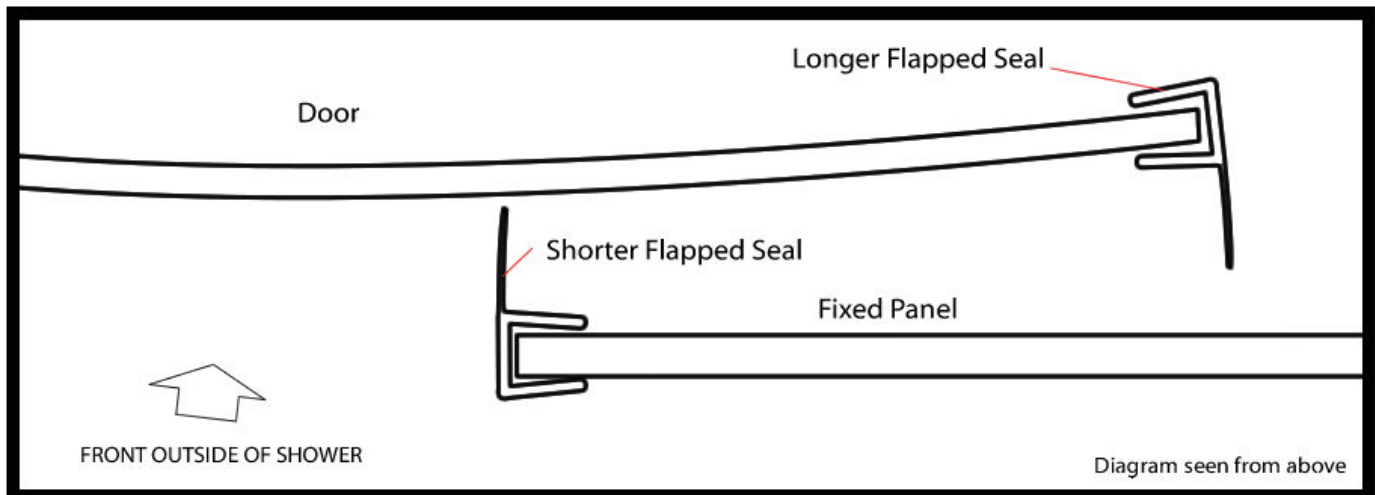

Water Connections

This product requires a hot and cold water supply. Your Hot and Cold water supply pipes should ideally be finished about 1 meter above the floor centrally in the corner and finished with 15mm compression isolating valve. The shower will require two braided flexible hoses that connect to these water supply pipes from the shower valve.

WATER PRESSURE: 1-3 bar (ideally above 2 for optimum results)

WATER FLOW: above 7.5 litres per minute

Important Note Do not exceed 3.4 BAR pressure under any circumstances. Warranty is void if so as damage will occur. If you have a combi supply, please use a pressure reducing valve if required to lower the BAR pressure to the shower.

Fitting Isolating valves is recommended as this makes service access easier than locating the house Stop Cock. Additionally Isolating valve enable you to disconnect water to the shower if you are away from home for long periods of time.

Combination boiler installation and PEV's

This product does not normally require a Pressure Equalising Valve (PEV) as it uses the latest generation of shower valve Thermostatic Cartridge, which enables it to handle un-balanced water pressures itself, to provide accurate temperature control.

This shower product can be connected to Combi Boiler system that provide suitable water pressure and water flow rates.

Gravity Fed and Shower Pumps

Where the water is supplied by a hot water cylinder (gravity fed type systems) a shower pump should be installed. Ideally a shower pump rated over 2 bar supplying just the shower is recommended, or alternatively a pump of higher specification can be fitted to supply multiple showers within the property.

When choosing a pump, a twin impeller pump is recommended as this will ensure both the hot and cold water is of the same pressure. (You must seek further advise from a plumber to correctly spec the right shower pumpp for your set-up

Always refer to the manufacturers instructions regarding shower pump installations and choose the correct type for your particular situation (negative head/positive head etc). All pipe work between the storage tank, cylinder and to the pump should be 22mm and the shower positioned at least 250mm below the header tank. Please note that locating the pump further from the shower and cylinder may reduce the effectiveness of the pump and will certainly reduce the output pressure of water.

Ensure the pump is correctly installed and commissioned. Failure to fit the pump in accordance with the manufactures instructions may result in inadequate water supplies and lead to pump pulsing etc.

Maximum pressure: The shower requires water pressure up to but not exceeding 3 bar.

Exceeding this maximum rating may damage the product and will invalidate your Guarantee.



CHECK ALL WATER CONNECTIONS ARE WATERTIGHT. PREFITTED CONNECTIONS MAY ONLY BE MADE HAND TIGHT AT MANUFACTURE AND/OR MAY WORK LOOSE IN TRANSIT

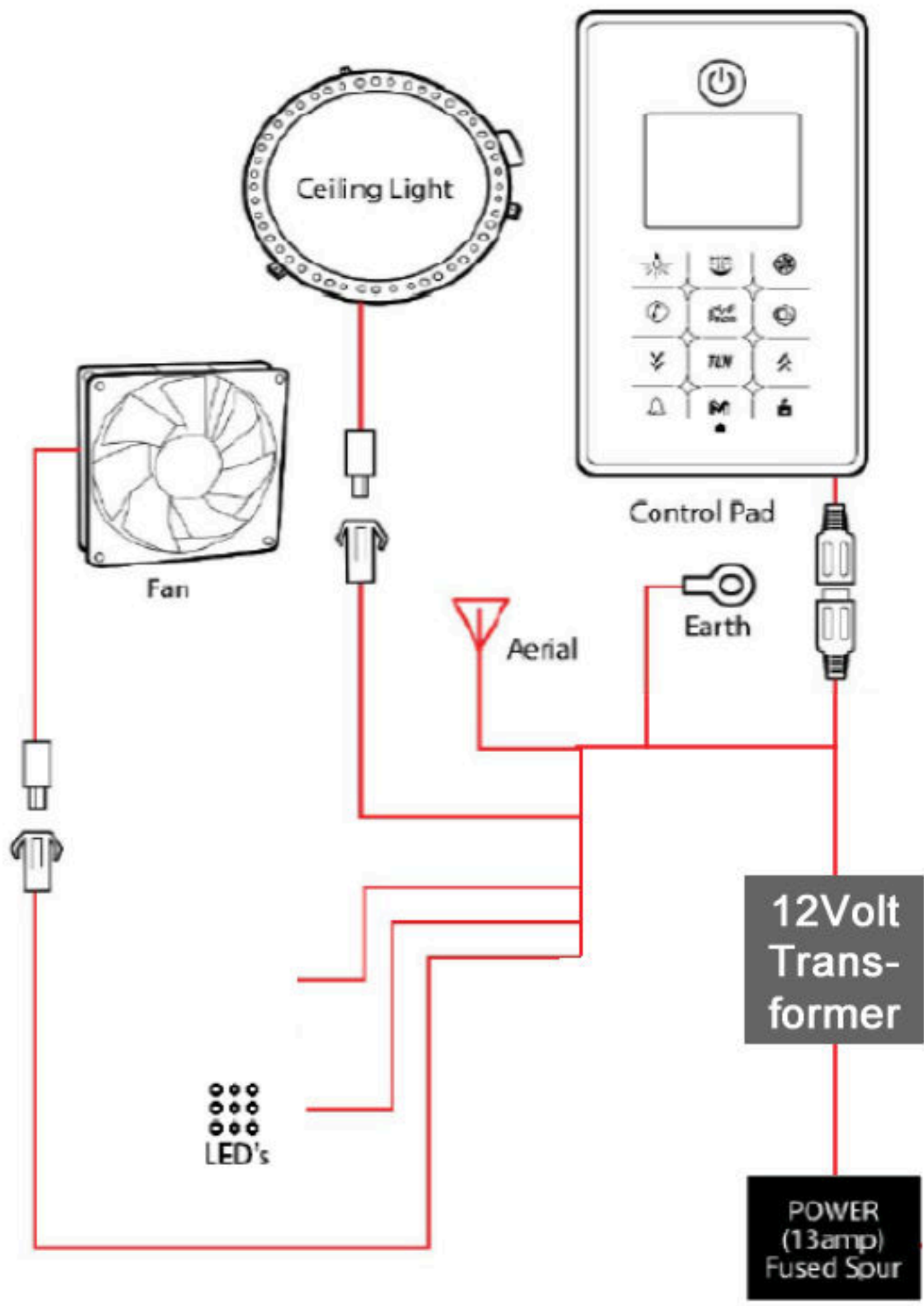

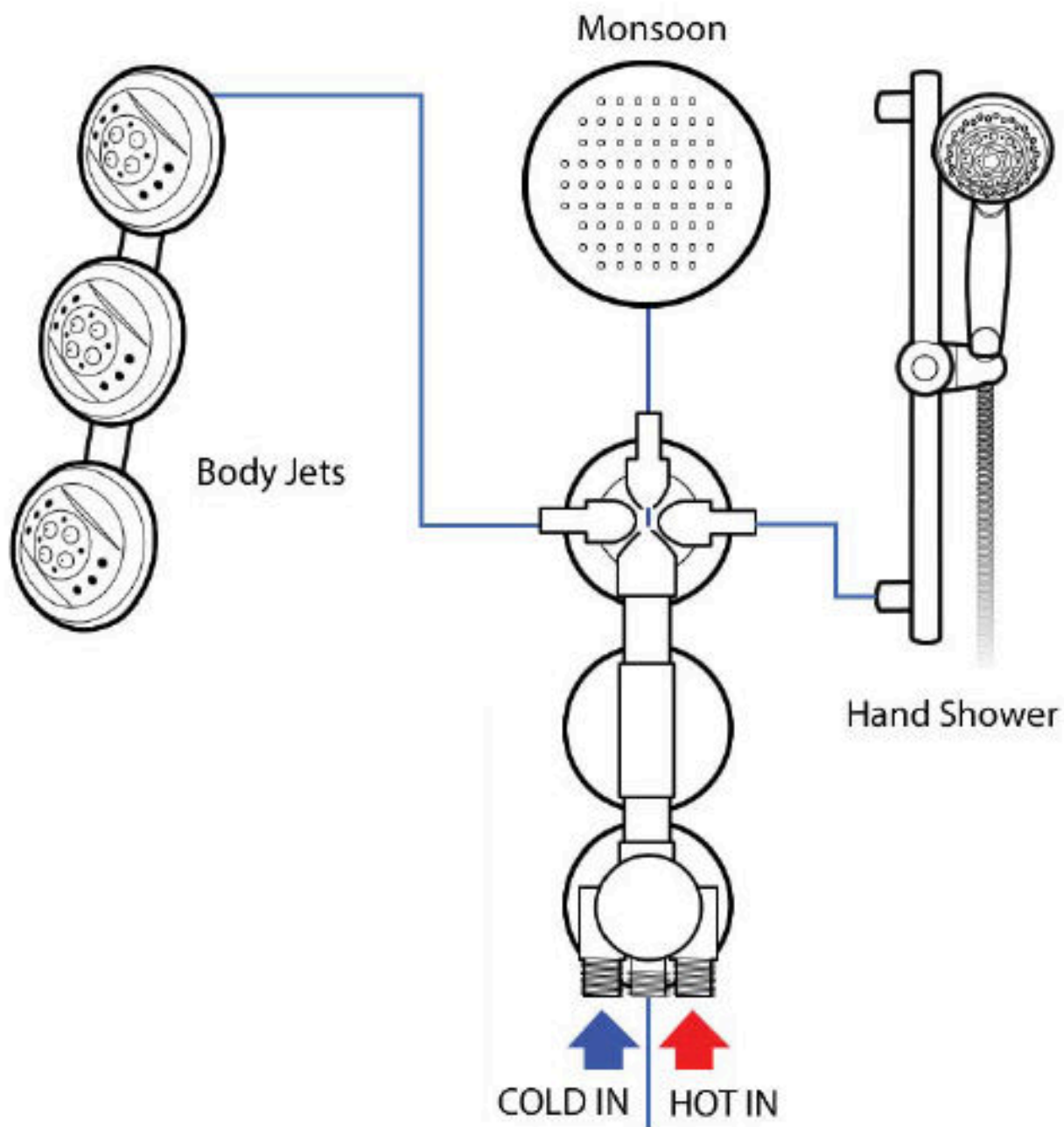

Electrical Connections

MAIN POWER

The shower is supplied with a 12 volt transformer that needs connecting to the mains

The Shower is delivered with a standard 3 pin plug on the end of the power cord. This is for **TESTING** purposes only.

For final fix this product **MUST** be connected via an ISOLATED FUSED SPUR. This work may require the services of a Qualified Part P Registered Electrician.

CONNECTING LIGHTS, FAN, OZONE Etc

Each component needs to be connected to the Electronic Control Unit.

Each component (Fan, Ozone, Speaker etc) has a thin 12v cable with a plug on the end. You will also see that each cable has a sticker with an icon to indicate what it is.

The electronic control unit behind the showers central tower panel has a large number of cables. Again, each of these cables has a similar plug and a label corresponding to those of the Fan, Ozone, Lights etc. Match each item and make the connection securely.

AERIAL

Position the Radio aerial wire in a position that allows the radio to receive the best possible signal. Note that local interference from Taxis, Ham Radio, Emergency Service, Hospitals etc may affect reception.

ELECTRONIC CONTROL PANEL

The Shower has an electronic control panel to allow you to operate and control the steam production, lights, radio and audio system. Locate the communication cable coming from the panel at the rear of the shower and connect it to the corresponding cable that will be found coming from the electric control unit. This connection uses a series of small pins inside, **CARE MUST BE TAKEN MAKING THIS CONNECTION** to not bend the pins. The plugs are marked with an ARROW to identify which way they connect.

You MUST ensure all electrical work is carried out in accordance with current Legal requirements.

Sealing the Shower

OPTIONAL:

Under normal use, the shower will return all water back into the tray. Should you choose, we recommend that you seal the shower internally with a good quality bathroom sealant to provide an extra level of water proofing.

All sealant placed on the inside of the shower with a good quality 'Anti-Moulding' Sealant.

After allowing the sealant to set (as per the sealant directions), move on to the water test and check for signs of water leaking, please attend to them as required.

Water Testing

This is an important step to complete the shower. You should test all fittings and fixtures of the shower to ensure the shower is fit for use.

Items such as, but not exclusive to, the connections for example are connect prior to delivery for illustration purposes ONLY and will not be water tight and further can become more loose during transit.

You should treat all connections and fittings as such and fully ensure all connections are complete and ready to be used

You should run and completely test all fixtures and features on the shower, as well as its water integrity to the level of normal use until you are confident of its completion

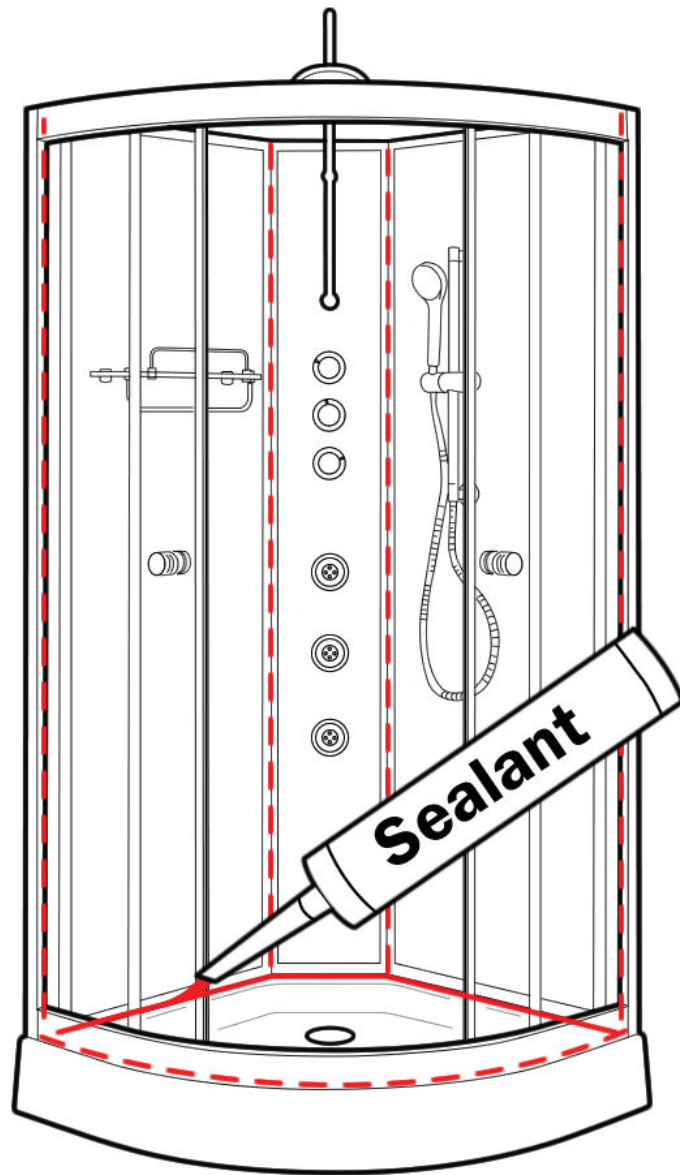

DO NOT PUT SEALANT INTO THE WATER RETURN CHANNELS

PLEASE NOTE:

The shower is made up of solid parts (glass, metal, Acrylic) Any leaks found during testing will be down to incorrect installation/sealing - you should spend a good amount of time water testing the shower before 'signing it off' with the customer to avoid returning

Due to the design of the shower, no excessive silicone should be on display. This means that with normal use and cleaning, there will not be any escape of over the trays edge and on to the bathroom floor. There will be areas on the shower where water will pass and escape to the shower tray, however this will travel around the tray and return via the water channels back into the shower.

There might be areas on the shower, like corners or gaps that during normal showering are subjected only to sustainable amounts of water. These areas when sprayed directly and heavily with the shower head in a fashion thats inconsistant to showering, may overwhelm the shower tray lip and return channels allowing water on to the bathroom floor. We guarantee our showers will not leak during regular showering use/practices without any silicone on show.

However, if you wish to obtain a further level of security you can do so by adding the sealant. You should water test and add where required as you test to gauge the level of sealing required to meet your requirement

Final Testing

Check and test that each outlet function (hand shower, body jets and monsoon) work as expected by rotating the DIVERTOR DIAL (top chrome dial).

Check the ON/OFF dial enables the water to be fully on or off in the position indicated on the valve markings.

Check the Temperature can be increased and decreased by turning the lower chrome shower valve dial. Test that the button can be pressed at 38 degrees to turn the dial to the hottest settings.

Check the water runs to the waste/plug efficiently. A small amount remaining in the tray is normal.

FAULT FINDING

Water does not exit tray fast enough.

The tray must be leveled and a suitable 'fall' on the tray that enable the water to run to the plug. Additionally, the waste hose (under the tray) should have suitable fall to allow water to exit quickly.

Water pressure / flow is low on some or all shower options.

Check all the hoses are not trapped or kinked and thus restricting flow. Check also that any washers are not out of position and restricting flow. Ensure you have OVER 7.5 litres per minute flow and over 2 bar water pressure.

Water is 'pulsing' .

If a pump has been used to supply water under pressure and the back jets, or hand shower cause the pump to start and stop (PULSING WATER), remove the NON RETURN VALVES. Remove the Braided hoses at the rear of the shower. Look inside the valve where the hoses connected and you will see a silver coloured 'C' clip. Remove this and this will enable the NRV to be removed (white plastic item). Refit the hoses and re-test. Pulsing may also be noted where a pump has not been fully commissioned and there is air in the system.

Doors do not meet correctly and or bind when opening or closing.

Adjust the door runner cam wheels correctly to enable smooth running and operation.

Water is leaking out of the shower.

Dry the shower fully. Once dry, turn on the shower and operate the functions and look for where the water is leaking from. Apply sealant to the area where the water is leaking from.

The shower temperature is low.

If the water in the rest of the house is at a suitable temperature, then you may need to replace the thermostatic cartridge. Limescale or other dirt can impair the function of the cartridge.

For more help with your shower, please call, our technical team will be on hand to help.

Valve Operation

There are 3 control dials inside your Shower Cabin. These dials control the output functions, water flow and temperature of your shower.

The top dial can be turned to allow you to choose which output you wish to use: Body Jets, Overhead (Monsoon) Shower and Hand Shower. Turn the dial to the required output, there will be an audible click as the selection is made. Do not turn the dial when water is flowing as this will decrease the life of the selector mechanism.

The middle dial adjusts the water flow rate. The dial rotates through 90 degrees. This dial also acts as the on/off for water flow.

The lower dial controls the temperature. The dial rotates from 20 degrees to 38 degrees and then will stop. This is a safety feature. To enable temperatures higher than 38 degrees, simply press the knob on the dial in (toward the main dial) and then turn the dial past the 38 degree mark.

Turning the temperature dial past 30 degrees MUST be done with care to prevent scaling.

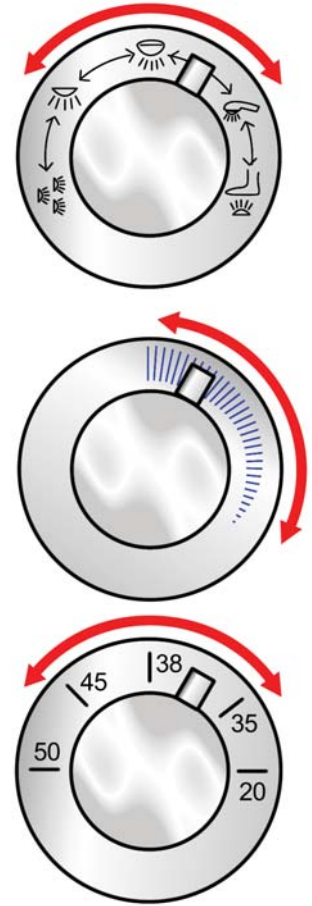

Safety Precautions

On models fitted with Steam functions, it is normal for the steam generator to get quite hot during use. Please allow up to half an hour for the generator to cool before touching associated areas including the steam pod.

Always disconnect or isolate the water supply to the shower before commencing any investigations, service or replacement of parts. Where the product has electrical power, this should also be turned off.

Children should NOT use the shower unless under strict adult supervision.

All products are single person occupancy unless otherwise sold as twin person.

The tray surface inside the product can become slippery especially if soap, gel or shampoo is on the surface, we therefore advise care when stepping in, out and during use.

Electronic Control Panel

Your shower is fitted with an electronic control panel that allows you to operate the electronic features of your shower.

From the control panel you can control the lights, Radio and Bluetooth audio.



Power ON / OFF

In standby mode this button is lit Red.

Press and keep pressing the power button until the panel beeps and the light turns Blue. The Panel is now active.

If the panel is not used for 30 seconds, the panel will LOCK. This is noted by the lines in the display FLASHING. To deactivate the LOCK, simply press and hold the POWER button until a beep is heard and the lines stop flashing.



LIGHTS

This model comes with an LED 'Halo' ring light surrounding the monsoon. Press the light button. With each press, the display will show ON1, ON2, ON3, OFF. The panel is able to accept up to three different light relays, hence the various light modes. Toggle to OFF to turn the light off.



FAN

The circulation fan can be activated to draw air/steam inside the cabin out. This may be used in conjunction with the steam.



RADIO

This button activates the built in FM Radio. In this mode the power button will be lit White. Pressing the TUN TEL button and then using the ARROW buttons allows you to change radio frequency.

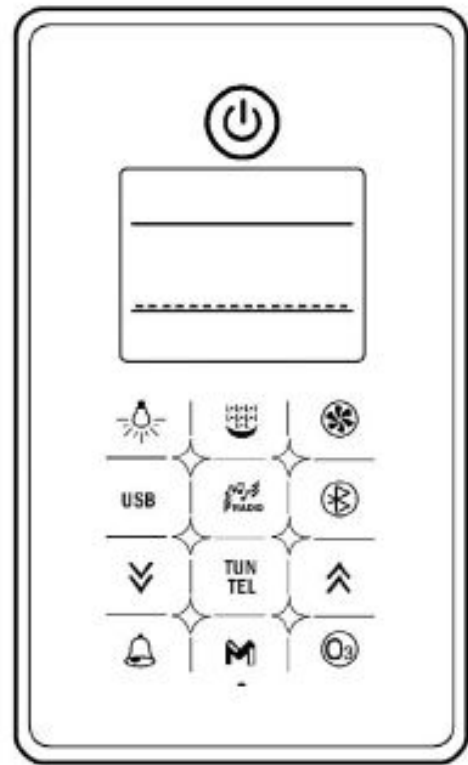

REMOVE PROTECTIVE FILM ON CONTROL PANEL BEFORE USE



BLUETOOTH

Pressing this button will allow you to receive audio played from Bluetooth enabled device. You can control volume and skip tracks as described for the USB option. You will have to PAIR the shower to a bluetooth device first - see following page. When this mode is activated then Power button will be lit Red.



ARROWS

The Arrow buttons control Tuning, Volume, Track Skip etc depending upon which mode is currently selected.



TUN TEL

Pressing this button will allow you to enter the tuning mode when the Radio is activated. The current frequency will be displayed and by using the Arrow keys can adjust the precise frequency.



M

The button can be used to Store Radio stations into Memory. The button also serves as a toggle the function of the ARROW keys for time/temperature/track/volume/tuning etc.

Bluetooth Pairing

Before you can start streaming Audio to your shower you must first establish a connection between the shower and the device that will stream the audio to the shower; this is called Pairing. You can stream up to 10 meters away, depending upon interference of walls etc.

Most devices that are Bluetooth Audio Streaming enabled can be connected to the shower, such as Smart Phones (Android, iPhone etc), Tablets (Galaxy Tab, iPad etc) and even computers and Laptops.

1: Press the BLUETOOTH Button on the control pad. The display will now say BT.

2: On your Smartphone/Tablet etc, go to the Bluetooth settings (If unsure, refer to your manual for more information on how to access this)

3: Ensure Bluetooth is active/running on your device.

4: Initiate a SEARCH/SCAN for New Devices to Pair to.

5: After a small amount of time you should see the device name of the shower appear "SPROUT". Select this to complete the Pairing of the two devices.

You are now ready to stream audio. Go to your music playing App, choose a track and press play.

Once Paired you can stream music at any time to the shower. Only once device can be Paired at any time.

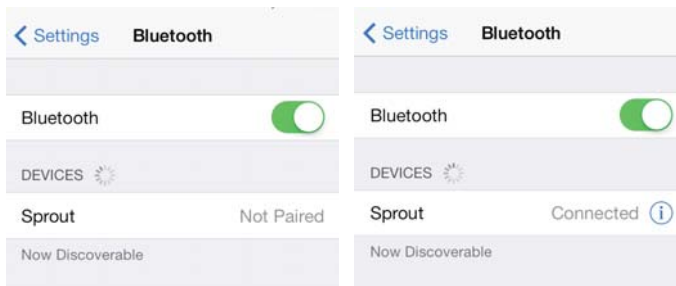

Due to the various different number of devices that have Bluetooth, and the variations on the implementation of Bluetooth enabled in your device we are unable to guarantee connectivity or to provide support for connecting, however the product has been tested on a number of Apple and Android Tablets and Phones with complete success.

Cleaning and third party product use

DO NOT CLEAN BY SPRAYING THE HAND SHOWER DIRECTLY INTO AREAS THAT MAY PASS WATER - UNLESS YOU HAVE ADDED THE ADDITIONAL INTERNAL SILICONE IN PREVIOUS STEP

This shower should be cleaned after every use to remove the build up of dirt and bacteria. We would recommend that after normal showering use, that the cabin doors are left open until the inside is fully dry. This will help prevent the build up of soap scum, dirt and bacteria.

The shower cabin can trap dirt in gaps between joints of panels etc, which may require extra care and attention during cleaning. To minimise dirt build up between panels, the application of a bead of silicone sealant suitable for shower/bathroom use will fill the gap leaving a smooth finish and both stop dirt build up and offer an extra level of water tightness.

The shower cabin can be cleaned with any suitable cleaning solution that is not abrasive, and is recommended by its manufacturer for use on acrylic, chrome and glass surfaces as appropriate to the materials in the shower. Not all general bathroom cleaners are designed for use on some materials of this product. Harsh abrasive cleaners containing bleach or peroxide **MUST NOT** be used

DO NOT USE CIF OR OTHER ABRASIVE CLEANING PRODUCTS ON THIS SHOWER.

In hard-water areas, wash down the unit and remove the dirt periodically. Fitting a water filtration device is also advisable in areas where the water is likely to lead to a build up of minerals within the pipes and diverter assembly. Hard water WILL reduce the life of the Parts that come into contact with water, such as the Thermostatic Valve. Fitting water softening devices will prevent this.

Thermostatic Cartridge

Your shower is fitted with a Thermostatic Cartridge. Should you need to remove or replace the cartridge for maintenance or replacement, follow the instructions below.

Q: I am having to turn the dial round as far as it will go to the hottest setting and the water is only just warm.

A: Your Thermostatic Cartridge has showed signs of failure. You will need to replace the Cartridge.

Q: Why did my Thermostatic Cartridge fail?

A: Hard Water areas will result in calcification, which will build up in the Cartridge. Other reasons might be age of the Cartridge or even dirt or debris collecting in the Cartridge from the pipes.

BEFORE STARTING ENSURE THAT THE WATER SUPPLIES ARE DISCONNECTED OR ISOLATED

It is imperative that the water supply to your shower in between 1 and 3 bar as exceeding this may damage the Thermostatic Cartridge.

First check behind the shower. On the bottom dial, is there a small screw in the valve body holding the thermostatic cartridge in place? If so, remove this and replace when finished

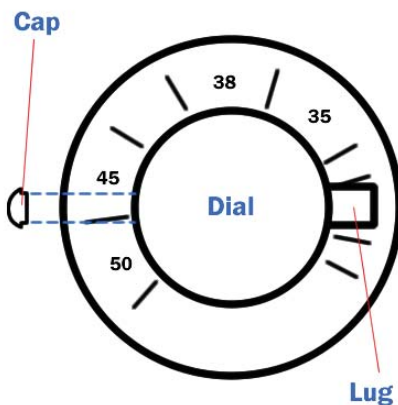

From inside the shower, on the lower of the three dials, remove the chrome coloured plastic cap that is fitted on the opposite side to the chrome lug.

The chrome cap will just pull off.

Keep the cap safe.

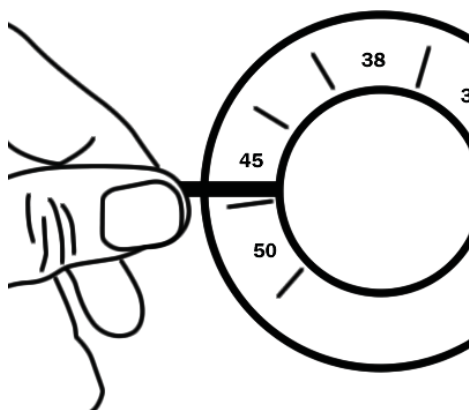

Using a 2.5mm Alan key, insert this into the hole where the chrome cap was fitted and loosen the grub screw about 1 turn to loosen.

DO NOT UNSCREW FULLY.

Now remove the chrome dial.

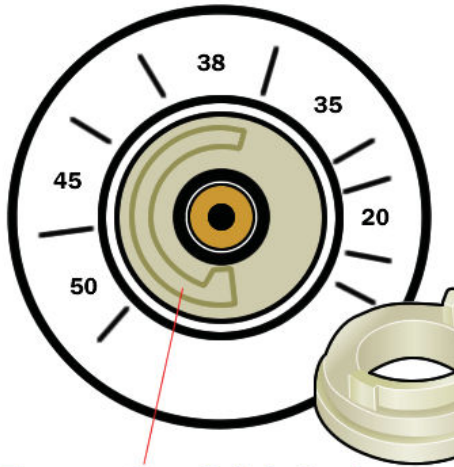

With the Chrome dial removed you will see a plastic ring covering with the Thermostat underneath.

Note down the position the ring is placed in.

Pull the plastic ring (Temperature safety lock) towards you to remove.

Keep this part safe

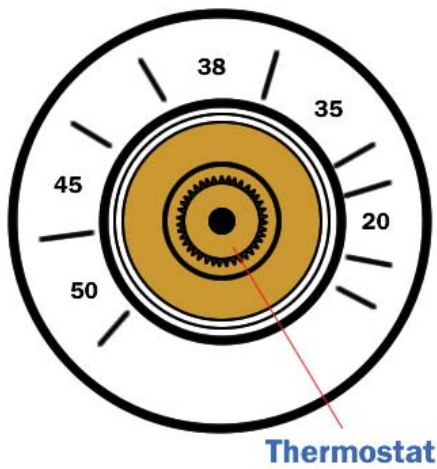

You will now see the head of the Thermostat clearly visible.

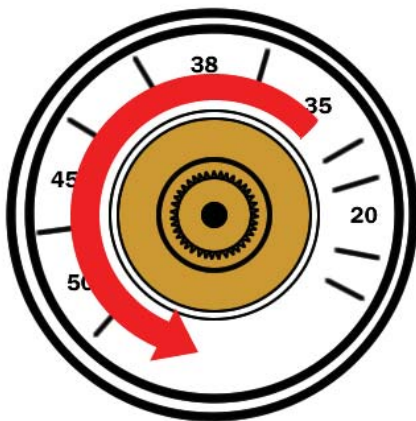

Turn the head of the cartridge counter-clockwise to remove.

To fit your new Thermostat, simple reverse this process.

**FOR TECHNICAL
ASSISTANCE**

PLEASE CALL

01524 489939

Shower Completion Form

This form must be filled out by the plumber/installer and electrician (where applicable) in order to validate the warranty. You are required to register the warranty online at www.vidalux.co.uk

PLEASE RETAIN THIS CERTIFICATE FOR FUTURE REFERENCE

You **MUST** register the product warranty within 90 days following delivery

Shower Details

Model No. **Date Of Delivery**

Invoice No. **Install Date**

Install Information

Water Supply Type **Combi** **Mega Flow/Pressurised**
 Pumped **Gravity Fed**

Cold Water Pressure (LPM or BAR) **Hot Water Pressure (LPM or BAR)**

PEV or PRV fitted? **PEV** **Details**
 PRV

Details of pressure testing/flow rate equipment used

Plumbing Installation

Installer Name **Company**

Address **Town/City**

Post Code **Contact Tel**

Credentials/Certificates held - Reg number

Signature **Date**

Electric Installation

Installer Name **Company**

Address **Town/City**

Post Code **Contact Tel**

Part P Reg No. **Date**

Signature